

Agilent 4395A Network/Spectrum/Impedance Analyzer

Programming Manual

SERIAL NUMBERS

This manual applies directly to instruments with serial number prefix JP1KE and MY411.
For additional important information about serial numbers, read in “Serial Number” in Chapter 12.



Agilent Part No. 04395-90021
Printed in JAPAN July 2001

Fourth Edition

Notice

The information contained in this document is subject to change without notice.

This document contains proprietary information that is protected by copyright. All rights are reserved. No part of this document may be photocopied, reproduced, or translated to another language without the prior written consent of the Agilent Technologies.

Agilent Technologies Japan, Ltd.
Component Test PGU-Kobe
1-3-2, Murotani, Nishi-ku, Kobe-shi,
Hyogo, 651-2241 Japan

MS-DOS[®] is a U.S. registered trademark of Microsoft Corporation.

The customer shall have the personal, non-transferable rights to use, copy, or modify SAMPLE PROGRAMS in this manual for the Customer's internal operations. The customer shall use the SAMPLE PROGRAMS solely and exclusively for their own purpose and shall not license, lease, market, or distribute the SAMPLE PROGRAMS or modification of any part thereof.

Agilent Technologies shall not be liable for the quality, performance, or behavior of the SAMPLE PROGRAMS. Agilent Technologies especially disclaims that the operation of the SAMPLE PROGRAMS shall be uninterrupted or error free. The SAMPLE PROGRAMS are provided AS IS.

AGILENT TECHNOLOGIES DISCLAIMS THE IMPLIED WARRANTIES OF MERCHANTABILITY AND FITNESS FOR A PARTICULAR PURPOSE.

Agilent Technologies shall not be liable for any infringement of any patent, trademark, copyright, or other proprietary rights by the SAMPLE PROGRAMS or their use. Agilent Technologies does not warrant that the SAMPLE PROGRAMS are free from infringements of such rights of third parties. However, Agilent Technologies will not knowingly infringe or deliver software that infringes the patent, trademark, copyright, or other proprietary right of a third party.

Manual Printing History

The manual's printing date and part number indicate its current edition. The printing date changes when a new edition is printed. (Minor corrections and updates that are incorporated at reprint do not cause the date to change.) The manual part number changes when extensive technical changes are incorporated.

September 1997 First Edition (part number: 04395-90001)
March 1998 Second Edition (part number: 04395-90011)
March 2000 Third Edition (part number: 04395-90011)
July 2001 Fourth Edition (part number: 04395-90021)

Typeface Conventions

Bold Boldface type is used when a term is defined. For example: **icons** are symbols.

Italics Italic type is used for emphasis and for titles of manuals and other publications.

Italic type is also used for keyboard entries when a name or a variable must be typed in place of the words in italics. For example: *copy filename* means to type the word *copy*, to type a space, and then to type the name of a file such as *file1*.

Computer Computer font is used for on-screen prompts and messages.

HARDKEYS Labeled keys on the instrument front panel are enclosed in .

SOFTKEYS Softkeys located to the right of the LCD are enclosed in .

Graphic Symbols

General definitions of other graphic symbols used in manuals.

COMPUTER



COMPUTER denotes information for a programmer using an external computer as the system controller.

iBASIC

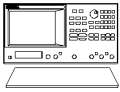

iBASIC denotes information for a programmer using an analyzer with HP Instrument BASIC as the system controller.

Documentation Map

The following manuals are available for the analyzer.

Operation Manual (Agilent Part Number 04395-900x0)

The Operation Manual describes all function accessed from the front panel keys and softkeys. It also provides information on options and accessories available, specifications, system performance, and some topics about the analyzer's features.

Programming Manual (Agilent Part Number 04395-900x1)

The Programming Manual shows how to write and use BASIC program to control the analyzer and describes how HP Instrument BASIC works with the analyzer..

HP Instrument BASIC Users Handbook (Agilent Part Number 04155-90151)

The HP Instrument BASIC User's Handbook introduces you to the HP Instrument BASIC programming language, provide some helpful hints on getting the most use from it, and provide a general programming reference. It is divided into three books, *HP Instrument BASIC Programming Techniques*, *HP Instrument BASIC Interface Techniques*, and *HP Instrument BASIC Language Reference*.

Service Manual (Option 0BW only), (Agilent Part Number 04395-901x0)

The Service Manual explains how to adjust, troubleshoot, and repair the instrument. This manual is option 0BW only.

The number indicated by "x" in the part number of each manual, is allocated for numbers increased by one each time a revision is made. The latest edition comes with the product.

Sample Program Disks

Two sample program disks (Agilent Part Number 04395-180x0) are furnished with 4395A. The disks contain the sample programs listed in this manual. The number indicated by “x” in the part number of each manual, is allocated for numbers increased by one each time a revision is made. The latest edition comes with the product.



Sample program disk for external controller (Disk 1 of 2)

This disk contains the programs for the users who work mainly on the external controller.



Sample program disk for HP Instrument BASIC (Disk 2 of 2)

This disk contains the programs for the users who work mainly on the 4395A using HP Instrument BASIC.

Contents

1. Introduction	
Document Concepts and Usage	1-1
Overview of the GPIB Remote Control System	1-1
Required Equipment	1-2
Controller	1-3
Device Selector	1-3
Writing and Running Programs	1-5
Easy Program Writing	1-5
Running (Executing) Programs	1-8
Saving Programs	1-8
Retrieving a Program You Saved	1-8
2. Programming Measurement Sequence	
GPIB Commands Overview	2-1
Sending a GPIB Command	2-1
To Execute an GPIB Command with a Parameter	2-2
To Execute a Query	2-2
To Program a Basic Measurement	2-4
Set I/O Path	2-5
Set Up the Measurement Parameters	2-5
Perform Calibration	2-6
Connect DUT	2-6
Trigger a Measurement	2-6
Post-Processing	2-7
Transfer Data	2-7
3. Processing and Transferring Data	
Data Processing Flow	3-2
To Modify Calibration Data	3-3
Read Error-Corrected Data	3-4
Modify Calibration Data	3-4
Restore Modified Calibration Data	3-4
To Modify Error-Corrected Data	3-5
Read Error-Corrected Data	3-6
Restore Modified Error-Corrected Data	3-6
To Modify Trace Data	3-7
Read Trace Data	3-8
Restore Modified Trace Data	3-8
To Get Measurement Data Using ASCII Format	3-9
Set the Receive Array	3-9
Set Data Transfer Format	3-10
Read Data	3-10

To Get Measurement Trace Using Binary Format	3-11
Set the Receive Array	3-12
Set Data Transfer Format	3-12
Read Data	3-12
Data Formats in Binary Transferring	3-13
File Headers	3-14
Saving a Data File	3-15
Creating a File to Contain the Data	3-15
Opening the File and Transferring the Data	3-15
Data Levels	3-16
Calibration Types and Standard Classes, and Calibration Arrays	3-17
4. Synchronizing the 4395A with a Controller	
Using the *OPC Command	4-2
Suspending a Program Running on a Controller (*OPC)	4-2
Using the WAIT Command of BASIC	4-2
Using the EXECUTE Statement to Synchronize with the Completion of Sweep	4-3
Using SRQ	4-3
Using the *WAI Command	4-4
5. Status Reporting System and Processing Generated Interruptions	
General Status Register Model	5-2
Event Register	5-2
Enable Register	5-3
Status Byte Register	5-3
Transition Filter and Condition Register	5-3
Status Register Structure	5-5
Status Bit Definitions of the Status Byte (STB)	5-6
Status Bit Definitions of ESB, ESR, and OSR	5-7
OSPT, OSNT	5-9
OSPT (Operation Status Positive Transition Filter)	5-9
OSNT (Operation Status Negative Transition Filter)	5-9
How to Use the Status Registers in a Program	5-10
Reading an Event Register Directly	5-10
To Report Command Error Occurrence	5-11
Enable Error Bit	5-11
Report Command Error	5-12
Output Error	5-12
Return to Execute GPIB command	5-13
To Wait for Sweep End	5-14
Enable Sweep-End Bit	5-14
Enable SRQ Interrupt	5-15
Wait Until Measurement Is Done	5-15
Generate SRQ	5-15

6. Using the Trigger System in 4395A	
To Measure Continuously	6-2
Set Trigger Source	6-2
Start Continuous Measurement Sweep	6-2
To Trigger a Measurement From the Controller	6-3
Set Trigger Source	6-3
Trigger a Measurement	6-3
Set Trigger Source	6-4
Trigger a Measurement	6-4
Setting the Gate Trigger	6-4
Setting the Gate Delay	6-5
Setting the Gate Length	6-5
7. Using the I/O Port	
Overview	7-1
To Synchronize External Handler with Analyzer	7-2
Send Signal to the External Handler	7-2
Read Signal from the External Handler	7-3
8-bit I/O port	7-4
I/O Pins	7-4
IBASIC Commands for the 8-bit I/O Port Control	7-4
GPIB Commands for the 8-bit I/O Port Control	7-4
The 24-bit I/O Port	7-5
I/O Port	7-5
Control Signal Lines	7-6
Port C or Port D Status Output Signal	7-6
WRITE STROBE Output Signal	7-6
INPUT1 Input Signal	7-6
OUTPUT1 or OUTPUT2 Output Signal	7-6
PASS/FAIL Output	7-7
WRITE STROBE Output for the PASS/FAIL Output	7-7
SWEEP END Output	7-7
+5V Output	7-7
Pin Assignment	7-8
Power-ON Default	7-10
Basic I/O circuit	7-11
IBASIC Commands for 24-bit I/O Port Control	7-11
Data Output	7-11
Data Input	7-12
GPIB commands for 24-bit I/O port control	7-12
Data Output	7-12
Data Input	7-12
Setting Input/Output Directions of Ports C and D	7-12
Positive or Negative Logic Setting	7-13
OUTPUT1 and OUTPUT2 Level Setting Commands	7-13
Checking Input to INPUT1	7-13

8. Application Programming	
To Read Data Using the Marker Search Function	8-2
Searching Maximum Value	8-2
Reading Data	8-3
Marker Readout	8-4
To Perform Limit Test	8-5
To Set List Sweep	8-8
To Print Analyzer Display	8-10
Printer Preparation	8-10
Execute Print	8-10
To Observe Printing	8-10
Programs for the Network Analyzer Mode	8-11
To Perform 1 Pass 2 Port Calibration	8-11
To Analyze a Filter	8-12
To Analyze a Crystal Filter	8-15
To Measure Gain Compression	8-21
Programs for the Spectrum Analyzer Mode	8-25
To Obtain Total Harmonic Distortion (THD)	8-25
To Obtain an Integral of a Power	8-26
To Obtain Adjacent Channel Power	8-29
To Obtain Occupied Power Bandwidth	8-31
To Calculate an S/N Ratio	8-34
Programs for the Impedance Analyzer Mode	8-37
To Perform Calibration	8-37
To Measure Capacitance and the factor D	8-38
To Measure a Varactor Diode Using DC Bias Sweep (With Option 010)	8-42
File Transfer Function	8-46
File Transfer from 4395A to External Controller	8-47
File Transfer from External Controller to 4395A	8-49
Displaying List of Files in Current Directory	8-52
Hints and Notes on Programming	8-54
Increasing your program execution speed	8-54
ANAOCH Command	8-54
Self-assigning of an GPIB Address	8-54
Key Stroke Recording	8-55
Solving Problems on Your Program	8-55
If There Is No Response From an Instrument on the GPIB Bus	8-55
If the Disk Cannot Be Read	8-55
If an GPIB Command Error Occurs	8-55
If a Query Error Occurs	8-55
9. Introducing HP Instrument BASIC System	
Overview of HP Instrument BASIC	9-1
Controlling the Analyzer	9-2
Using HP Instrument BASIC for the First Time	9-2
Allocating Screen Area for HP Instrument BASIC	9-2
Entering BASIC Statements from the Front Panel Keys	9-3
Getting into/out of the EDIT Mode	9-3
Getting into the EDIT Mode	9-3
Entering the EDIT Mode from the Keyboard	9-3
Getting Out of the EDIT Mode	9-3

Editing Programs in the EDIT Mode	9-4
Deleting Characters	9-4
Back Space	9-4
Deleting Characters	9-4
Inserting Characters	9-4
Moving the Cursor	9-4
Scrolling Lines and Pages	9-4
Scrolling Lines	9-4
Scrolling Pages	9-5
Jumping from the Current Line	9-5
Jumping to a Specified Line	9-5
Jumping to the Top/Bottom of a Program	9-5
Inserting/Deleting/Recalling Lines	9-5
Clearing Line	9-5
Renumbering Program Line Numbers	9-6
Listing Programs	9-6
Listing on the Screen	9-6
Listing to the Printer	9-6
Saving Programs (SAVE)	9-7
Listing File Names (CAT)	9-8
Listing to Screen	9-8
Listing to Printer	9-8
Getting Programs (GET)	9-9
On Key Label Function	9-9
Pass Control Between the External Controller	9-10
Pass Control	9-10
To Execute an HP Instrument BASIC Command from the External Controller	9-11
To Load an Array in an HP Instrument BASIC Program to the External Controller	9-12
Available I/O Interfaces and Select Codes	9-12
External RUN/CONTInue Connector	9-12
Graphics	9-13
HP Instrument BASIC Graphics Commands	9-13
Hard Copies	9-14
Initial settings	9-14
Example of Graphics Programming	9-14
Drawing a Straight Line	9-14
Drawing a Circle	9-14
The Keyboard	9-15
Character Entry Keys	9-15
Cursor-Control and Display-Control Keys	9-15
Numeric Keypad	9-16
Editing Keys	9-16
Program Control Keys	9-16
System Control Keys	9-17
Softkeys and Softkey Control	9-17
Softkey Control Keys	9-17
Softkeys	9-17
Softkeys Accessed from Shift - F9 Key	9-18
IBASIC Menu	9-18
Softkeys Accessed form F10 Key	9-19

Using CTRL Key in Edit Mode	9-19
Run Light Indications	9-20
BASIC Commands Specific to 4395A	9-21
DATE	9-21
DATE\$	9-21
EXECUTE	9-21
READIO	9-22
SET TIME	9-22
SET TIMEDATE	9-22
TIME	9-23
TIME\$	9-23
WRITEIO	9-23
BASIC Commands Not Implemented	9-24
10. Facilitating Program Execution and Utilizing Storage Devices	
Running a Program through the Softkey Interface	10-1
Automatically Starting a Program at Power-ON (AUTOST)	10-2
Using Storage Devices	10-3
Floppy Disk Drive	10-3
Memory Disk	10-4
11. Command Reference	
12. Manual Changes	
Introduction	12-1
Manual Changes	12-1
Serial Number	12-2
Change 1	12-3
A. Commands in Entry Block A	
ADDRCONT \square <numeric>	A-1
ANAOCH{1 2}	A-1
ATT[R A B] \square <numeric>[DB]	A-2
ATTAUTO \square {OFF ON 0 1}	A-2
ATTP{1 2} \square <numeric>[DB]	A-3
AUTO	A-3
AVER \square {OFF ON 0 1}	A-3
AVERFACT \square <numeric>	A-4
AVERREST	A-4
B. Commands in Entry Block B	
BACI \square <numeric>[PCT]	B-1
BEEPDONE \square {OFF ON 0 1}	B-1
BEEPFAIL \square {OFF ON 0 1}	B-2
BEEPWARN \square {OFF ON 0 1}	B-2
BLIGHT \square {OFF ON 0 1}	B-2
BOTV \square <numeric>	B-3
BW \square <numeric>[HZ]	B-3
BWAUTO \square {OFF ON 0 1}	B-4
BWLMT <numeric>	B-4
BWSRAT \square <numeric>[PCT]	B-4

C. Commands in Entry Block C (*C included)

C0	<i><numeric></i>	C-1
C1	<i><numeric></i>	C-1
C2	<i><numeric></i>	C-2
CALCASSI		C-2
CALECPARA		C-2
CALI	{NONE RESP RAI S111 S221 FUL2 ONE2 IMP}	C-2
CALK	{APC7 APC35 N50 N75 USED}	C-3
CALS	<i><numeric></i>	C-3
CBRI	<i><numeric></i> [PCT]	C-3
CENT	<i><numeric></i> [HZ DBM]	C-4
CHAD	<i><string></i>	C-4
CHAN	{1 2}	C-4
CIN		C-5
CIRF	{RI LIN LOG RX GB SWR}	C-5
CLAD		C-5
CLASIMP	{A B C}	C-5
CLASS11	{A B C}	C-6
CLASS22	{A B C}	C-6
CLEL		C-6
CLES		C-6
*CLS		C-6
CLOSE		C-6
CNTS	<i><numeric></i> [HZ DBM]	C-7
CNTSAUTO	{OFF ON 0 1}	C-7
COLO	<i><parameter></i>	C-7
COLOR	<i><numeric></i> [PCT]	C-8
COMC	{A B C}	C-9
COMCDAT	{A B C}{OFF ON 0 1}	C-9
COMKDONE		C-9
COMP		C-10
COMS		C-10
COMSDONE		C-10
CONT		C-10
CONV	<i><parameter></i>	C-10
COPA		C-11
COPT	{OFF ON 0 1}	C-11
CORR	{OFF ON 0 1}	C-11
COUC	{OFF ON 0 1}	C-12
COUT		C-12
CRED	<i><string></i>	C-12
CWFREQ	<i><numeric></i> [HZ]	C-12
CWD?		C-13

D. Commands in Entry Block D

DATAOVAL□<numeric>	D-1
DATGAIN□<numeric>	D-1
DATMEM	D-1
DATOVAL□<numeric>	D-2
DATOVE	D-2
DAYMYEAR	D-2
DCCTL□{VOLT CURR}	D-2
DCI□<numeric>[A]	D-3
DCO□{OFF ON 0 1}	D-3
DCV□<numeric>[V]	D-3
DEFC	D-3
DEFEC{R1 C1 L1 C0}□<numeric>	D-4
DEFGO	D-4
DEFS□{1-8}	D-4
DEFSLOAD{R L}□<numeric>	D-5
DEFSOPEN{G C}□<numeric>	D-5
DEFSSHOR{R L}□<numeric>	D-6
DET□{POS NEG SAM}	D-6
DHOLD□□{OFF MAX MIN}	D-7
DIN	D-7
DISA□{ALLI HIHB ALLB BASS}	D-7
DISECIRC {OFF ON 0 1}	D-8
DISECPARA {OFF ON 0 1}	D-8
DISF□{DOS LIF}	D-8
DISL	D-9
DISLLIST	D-9
DISMAMP□{UL MD}	D-9
DISMPRM□{STSP CTSP}	D-9
DISP□{DATA MEMO DATM}	D-10
DMKR□{ON FIX TRAC OFF}	D-10
DMKRAUV□<numeric>	D-10
DMKRPRM□<numeric>[HZ DBM]	D-11
DMKRVAL□<numeric>	D-11
DONE	D-11
DOUT	D-12
DSKEY	D-12
DUAC□{OFF ON 0 1}	D-12

E. Commands in Entry Block E (*E included)

EDITDONE	E-1
EDITLIML	E-1
EDITLIST	E-1
ELED□<numeric>[S MS US NS PS FS]	E-1
ENKEY	E-2
EQUC□CIR{A B C D E}	E-2
ESB?	E-2
*ESE□<numeric>	E-2
ESNB□<numeric>	E-3
*ESR?	E-3
EXPP□{OFF ON 0 1}	E-3

F. Commands in Entry Block F	
FILC \sqcup $\langle string1 \rangle, \langle string2 \rangle, \langle string3 \rangle, \langle string4 \rangle$	F-1
FIXE \sqcup $\langle numeric \rangle$	F-1
FIXKDONE	F-1
FIXT \sqcup {NONE HP16191 HP16192 HP16193 HP16194 USED}	F-2
FMT \sqcup $\langle parameter \rangle$	F-2
FNAME? \sqcup $\langle numeric \rangle$	F-3
FNUM?	F-3
FORM2	F-3
FORM3	F-3
FORM4	F-3
FORM5	F-4
FREQ	F-4
FSIZE? \sqcup $\langle string \rangle$	F-4
FULS	F-4
FWDI	F-5
FWDM	F-5
FWDT	F-5
G. Commands in Entry Block G	
GATCTL \sqcup {LEV EDG}	G-1
GATDLY \sqcup $\langle numeric \rangle$ [S]	G-1
GATLEN \sqcup $\langle numeric \rangle$ [S]	G-2
GCLEAR	G-2
GRODAPER \sqcup $\langle numeric \rangle$ [PCT]	G-2
H. Commands in Entry Block H	
HOLD	H-1
I. Commands in Entry Block I (*I included)	
*IDN?	I-1
INID	I-1
INP8IO?	I-1
INPT?	I-1
INPUCALC{1-12} \sqcup $\langle numeric (1) \rangle, \langle numeric (2) \rangle, \dots, \langle numeric (n) \rangle$	I-2
INPUCALK \sqcup $\langle block \rangle$	I-2
INPUCOMC{1 2 3} \sqcup $\langle numeric (1) \rangle, \langle numeric (2) \rangle, \dots, \langle numeric (n) \rangle$	I-2
INPUDATA \sqcup $\langle numeric (1) \rangle, \langle numeric (2) \rangle, \dots, \langle numeric (n) \rangle$	I-3
INPUDTRC \sqcup $\langle numeric (1) \rangle, \langle numeric (2) \rangle, \dots, \langle numeric (n) \rangle$	I-3
INPURAW{1-4} \sqcup $\langle numeric (1) \rangle, \langle numeric (2) \rangle, \dots, \langle numeric (n) \rangle$	I-3
INTE \sqcup $\langle numeric \rangle$ [PCT]	I-3
ISOD	I-4
ISOL	I-4

K. Commands in Entry Block K

KEY	\sqcup <i><numeric></i>	K-1
KITD		K-1

L. Commands in Entry Block L

LABECOMK	\sqcup <i><string></i>	L-1
LABEFIX	\sqcup <i><string></i>	L-1
LABEFLWD	\sqcup {T M} \sqcup <i><string></i>	L-2
LABELIMP	\sqcup {A B C} \sqcup <i><string></i>	L-2
LABERES	\sqcup {P I} \sqcup <i><string></i>	L-2
LABEREV	\sqcup {T M} \sqcup <i><string></i>	L-3
LABES11	\sqcup {A B C} \sqcup <i><string></i>	L-3
LABES22	\sqcup {A B C} \sqcup <i><string></i>	L-3
LABK	\sqcup <i><string></i>	L-4
LABS	\sqcup <i><string></i>	L-4
LIMCLEL		L-4
LIMD	\sqcup <i><numeric></i>	L-4
LIMEDONE		L-5
LIMIAMPO	\sqcup <i><numeric></i>	L-5
LIMILINE	\sqcup {OFF ON 0 1}	L-5
LIMIPRMO	\sqcup <i><numeric></i>	L-5
LIMITEST	\sqcup {OFF ON 0 1}	L-6
LIML	\sqcup <i><numeric></i>	L-6
LIMM	\sqcup <i><numeric></i>	L-6
LIMPRM	\sqcup <i><numeric></i> [HZ DBM]	L-7
LIMSADD		L-7
LIMSDEL		L-7
LIMSDON		L-7
LIMSEDI	\sqcup [<i><numeric></i>]	L-8
LIMU	\sqcup <i><numeric></i>	L-8
LISDFBASE		L-8
LISDOBASE		L-9
LISV		L-9
LVCDDT	[A B R] \sqcup <i><numeric></i> [DB]	L-9

M. Commands in Entry Block M

MATH	\sqcup {DATA DDVM DMNM DPLM}	M-1
MAXDCI	\sqcup <i><numeric></i> [A]	M-1
MAXDCV	\sqcup <i><numeric></i> [V]	M-2
MEAS	\sqcup <i><parameter></i>	M-2
MEASTAT	\sqcup {OFF ON 0 1}	M-4
MKR	\sqcup {OFF ON 0 1}	M-4
MKRAMPO		M-5
MKRAUV?		M-5
MKRRCENT		M-5
MKRRCNT	\sqcup {OFF ON 0 1}	M-5
MKRRCOUP	\sqcup {OFF ON 0 1}	M-6
MKRDELA		M-6
MKRRL	\sqcup {OFF ON 0 1}	M-6
MKRMIDD		M-7
MKRNOI	\sqcup {OFF ON 0 1}	M-7

MKRO□{DATA MEMO}	M-7
MKROFS	M-7
MKRP□<numeric>	M-8
MKRPKD	M-8
MKRPRM□<numeric>[HZ DBM]	M-8
MKRREF	M-8
MKRSTAR	M-9
MKRSTOP	M-9
MKRSWPRM	M-9
MKRTHRE	M-9
MKRTIME□{OFF ON 0 1}	M-9
MKRUNIT□{DBM DBV DBUV W V}	M-10
MKRVAL?	M-10
MKRZM	M-10
MODI1	M-10
MODICOMK	M-11
MODIFIX	M-11
MONDYEAR	M-11

N. Commands in Entry Block N

NA	N-1
NEGL	N-1
NEXP	N-1
NUMG□<numeric>	N-1

O. Commands in Entry Block O (*O included)

OFSD□<numeric>[S]	O-1
OFSL□<numeric>	O-1
OFSZ□<numeric>[OHM]	O-2
OMI1	O-2
*OPC	O-2
OPEP	O-2
*OPT?	O-3
OSE□<numeric>	O-3
OSER?	O-3
OSNT□<numeric>	O-4
OSPT□<numeric>	O-4
OSR?	O-4
OUT1ENV{H L}	O-4
OUT1{H L}	O-5
OUT2ENV{H L}	O-5
OUT2{H L}	O-5
OUT8IO□<numeric>	O-5
OUTAIO□<numeric>	O-6
OUTBIO□<numeric>	O-6
OUTCIO□<numeric>	O-6
OUTDIO□<numeric>	O-6
OUTEIO□<numeric>	O-7
OUTFIO□<numeric>	O-7
OUTGIO□<numeric>	O-7
OUTHIO□<numeric>	O-7

OUTPCALC{1-12}?	O-8
OUTPCALK?	O-8
OUTPCOMC{1 2 3}?	O-8
OUTPCOMK?	O-8
OUTPINPCIO?	O-9
OUTPDATA?	O-9
OUTPDATAP?□<numeric>	O-9
OUTPDMKR?	O-10
OUTPDTRC?	O-10
OUTPDTRCP?□<numeric>	O-10
OUTPERRO?	O-11
OUTPFAIP?	O-11
OUTPINPCIO?	O-11
OUTPINPDIO?	O-11
OUTPINPEIO?	O-12
OUTPLIMF?	O-12
OUTPLIML?	O-12
OUTPLIMM?	O-13
OUTPMEMO?	O-13
OUTPMEMOP?□<numeric>	O-13
OUTPMKR?	O-14
OUTPMSTA?	O-14
OUTPMTRC?	O-14
OUTPMTRCP?□<numeric>	O-14
OUTPMWID?	O-15
OUTPRAW{1-4}?	O-15
OUTPSMKR{1-7}?	O-15
OUTPSWPRM?	O-15
OUTPSWPRMP?□<numeric>	O-16

P. Commands in Entry Block P (*P included)

PARS□{OFF ON 0 1}	P-1
*PCB□<numeric>	P-1
PEAKCENT	P-1
PEAKREF	P-2
PEN□{1-6}	P-2
PHAO□<numeric>[DEG]	P-2
PHAU {RAD DEG}	P-3
PKDLTX□<numeric>[HZ DBM]	P-3
PKDLTY□<numeric>	P-3
PKPOL□{POS NEG}	P-4
PKTHRE□{OFF ON 0 1}	P-4
PKTHVAL□<numeric>	P-4
POIN□<numeric>	P-5
PORE□{OFF ON 0 1}	P-5
PORT1□<numeric>[S MS US NS PS]	P-5
PORT2□<numeric>[S]	P-6
PORTA□<numeric>[S]	P-6
PORTB□<numeric>[S]	P-6
PORTR□<numeric>[S]	P-7
PORTZ□<numeric>	P-7

POSL	P-7
POWE□<numeric>[DBM]	P-7
PREP	P-8
PRES	P-8
PRIC	P-8
PRICFIXE	P-8
PRICVARI	P-9
PRINALL	P-9
PRIS	P-9
PRSMKRS	P-9
PRSOFT□{OFF ON 0 1}	P-10
PURG□<string>	P-10

R. Commands in Entry Block R (*R included)

RAID	R-1
RAIISOL	R-1
RAIRESP	R-1
READ?	R-1
RECC	R-2
RECD□<string>	R-2
REFD	R-2
REFL	R-3
REFP□<numeric>	R-3
REFV□<numeric>	R-3
REFX□<numeric>	R-3
REFY□<numeric>	R-4
RESAVD□<string>	R-4
RESC	R-4
RESCOM	R-4
RESD	R-5
RESPDONE	R-5
REST	R-5
RESTMDISK□{2}	R-5
REVI	R-6
REVM	R-6
REVT	R-6
RFO□{OFF ON 0 1}	R-6
ROPEN□<string>	R-6
RSCO	R-7
*RST	R-7

S. Commands in Entry Block S (*S included)

SA	S-1
SADD□<numeric>	S-1
SAUNIT□{DBM DBV DBUV W V}	S-1
SAV1	S-2
SAV2	S-2
SAVC	S-2
SAVCAL□{OFF ON 0 1}	S-2
SAVCOM	S-3
SAVDASC□<string>	S-3

SAVDAT□{OFF ON 0 1}	S-3
SAVDDAT□<string>	S-3
SAVDTIF□<string>	S-4
SAVDSTA□<string>	S-4
SAVDTRC□{OFF ON 0 1}	S-4
SAVEUSEK	S-5
SAVIMP	S-5
SAVMEM□{OFF ON 0 1}	S-5
SAVMTRC□{OFF ON 0 1}	S-5
SAVRAW□{OFF ON 0 1}	S-6
SAVUCOMK	S-6
SAVUFIXT	S-6
SCAC□{OFF ON 0 1}	S-6
SCAF□{DATA MEMO}	S-7
SCAL□<numeric>	S-7
SCRN□{OFF ON 0 1}	S-7
SDEL	S-8
SDON	S-8
SEAL	S-8
SEAM□{PEAK MAX MIN TARG PKSA PKSR PKSL OFF}	S-8
SEANPK	S-9
SEANPKL	S-9
SEANPKR	S-9
SEAR	S-9
SEARSTR	S-9
SEARSTRL	S-9
SEARSTRR	S-10
SEATARG□<numeric>[DB DEG S OHM]	S-10
SEDI□<numeric>	S-10
SETCDATE□<numeric (year)>,<numeric (month)>,<numeric (day)>	S-11
SETCTIME□<numeric (hour)>,<numeric (minute)>,<numeric (second)>	S-11
SETZ□<numeric>[OHM]	S-11
SGTRK□{OFF ON 0 1}	S-12
SIMFCHAR	S-12
SING	S-12
SMKR{1-7}□{OFF ON 0 1}	S-12
SMKRAUV{1-7}?	S-13
SMKRP{1-7}□<numeric>	S-13
SMKRPRM{1-7}□<numeric>[HZ DBM]	S-13
SMKRVAL{1-7}?	S-14
SPAN□<numeric>[HZ DBM]	S-14
SPECFWD{M T}□<numeric (1)>[,<numeric (2)>[,... [,<numeric (7)>]	S-14
SPECIMP{A B C}□<numeric 1>[,<numeric 2>[,... [,<numeric 7>]	S-15
SPECRES{I P}□<numeric (1)>[,<numeric (2)>[,... [,<numeric (7)>]	S-15
SPECREV{M T}□<numeric (1)>[,<numeric (2)>[,... [,<numeric (7)>]	S-15
SPECS11{A B C}□<numeric (1)>[,<numeric (2)>[,... [,<numeric (7)>]	S-15
SPECS22{A B C}□<numeric (1)>[,<numeric (2)>[,... [,<numeric (7)>]	S-16
SPLD□{OFF ON 0 1}	S-16
SQUI	S-16
*SRE□<numeric>	S-16
STAN{A-G}	S-17

STAR	␣<numeric>[HZ DBM]	S-17
*STB?		S-17
STDD		S-17
STDT	␣{OPEN SHOR LOAD DELA ARBI}	S-18
STOD	{DISK MEM0}	S-18
STOP	␣<numeric>[HZ DBM]	S-18
STORMDISK		S-19
SVCO		S-19
SWAI	␣<numeric>	S-19
SWET	␣<numeric>[S]	S-19
SWETAUTO	␣{OFF ON 0 1}	S-20
SWPT	␣{LINF LOGF LIST POWE}	S-20
T. Commands in Entry Block T (*T included)		
TERI	␣<numeric>[OHM]	T-1
TESS?		T-1
TINT	␣<numeric>	T-1
TITL	␣<string>	T-2
TMARG	␣<numeric>	T-2
TOPV	␣<numeric>	T-2
TRACK	␣{OFF ON 0 1}	T-3
TRAD		T-3
TRAN		T-3
*TRG		T-3
TRGEVE	␣{SWE POIN}	T-3
TRGP	␣{POS NEG}	T-4
TRGS	␣{INT EXT BUS MAN GAT}	T-4
*TST?		T-4
U. Commands in Entry Block U		
USKEY		U-1
V. Commands in Entry Block V		
VBW	␣<numeric>	V-1
VBWT	␣{LIN LOG}	V-1
VELOFACT	␣<numeric>	V-1
W. Commands in Entry Block W (*W included)		
*WAI		W-1
WIDSIN		W-1
WIDSOUT		W-1
WIDT	␣{OFF ON 0 1}	W-1
WIDV	␣<numeric>	W-2
WIDVTYPE	␣{DIVS2 MULS2 DIV2 FIXed}	W-2
WOPEN	␣<string>[,<numeric>]	W-2
WRITE	␣<block>	W-3

X. Commands in Entry Block X

XMKRCENT	X-1
XMKRSTAR	X-1
XMKRSTOP	X-1
XMKRZM	X-1
XPEAKCENT	X-1

Z. Commands in Entry Block Z (Other commands included)

ZA	Z-1
ZMAPER␣<numeric>	Z-1
Other Commands	Z-2
:PROGram[:SElected]:DEFine␣<block>	Z-2
:PROGram[:SElected]:DELete[:SElected]	Z-3
:PROGram[:SElected]:DELete:ALL	Z-3
:PROGram[:SElected]:EXECute␣<string>	Z-3
:PROGram[:SElected]:MALLocate␣{<numeric> DEFault}	Z-3
:PROGram[:SElected]:NAME␣<string>	Z-3
:PROGram[:SElected]:NUMBer␣<string>,<numeric (1)>[,<numeric (2)>[, . . . [,<numeric (n)>]	Z-3
:PROGram[:SElected]:STATe␣{RUN PAUse STOP CONTInue}	Z-4
:PROGram[:SElected]:STRing␣<string (varname)>,<string (value 1)>[,<string (value 2)> [, . . . [,<string (value n)>]	Z-4
:PROGram[:SElected]:WAIT	Z-5
:PROGram:EXPLicit:DEFine␣“PROG”,<string>	Z-5
:PROGram:EXPLicit:DELete␣“PROG”	Z-5
:PROGram:EXPLicit:EXECute␣“PROG”,<string>	Z-5
:PROGram:EXPLicit:MALLocate␣“PROG”,{<numeric> DEFault}	Z-6
:PROGram:EXPLicit:NAME␣“PROG”,<string>	Z-6
:PROGram:EXPLicit:NUMBer␣“PROG”,<string> [,<numeric>]	Z-6
:PROGram:EXPLicit:STATe␣“PROG”,{RUN PAUse STOP CONTInue}	Z-6
:PROGram:EXPLicit:STRing␣“PROG”,<varname>[,<string>]	Z-6
:PROGram:EXPLicit:WAIT “PROG”	Z-6

Messages

Status Notations	Messages-1
Error Messages in Numerical Order	Messages-2

Index

Figures

1-1. Configuration of an GPIB Remote Control System	1-3
2-1. Program Flow	2-4
2-2. Sample Program : Basic Measurement (1/2)	2-4
3-1. Data Arrays, Data Processing, and GPIB Command	3-2
3-2. Sample Program : To Modify Calibration Data	3-3
3-3. Sample Program : To Modify Error-Corrected Data	3-5
3-4. Sample Program : To Modify Trace Data	3-7
3-5. Sample Program : To Get Measurement Trace Using ASCII Format	3-9
3-6. Sample Program : To Get Measurement Trace Using IEEE 64-bit Floating Point Format (For External Controller)	3-11
3-7. Form 2 Data Transfer Format	3-13
3-8. Form 3 Data Transfer Format	3-13
3-9. FORM3 Data Transfer Format	3-14
3-10. Saving Data on a Floppy Disk	3-15
4-1. Sample program: Wait until the preceding command is completed.	4-2
4-2. Sample program: Wait until the preceding command is completed.	4-3
5-1. General Status Register Model	5-2
5-2. Transition Filter and Condition Register	5-3
5-3. Status Reporting Structure	5-5
5-4. Example of Reading Status Byte (1)	5-6
5-5. Example of Reading Status Byte (2)	5-6
5-6. Example of Generating a Service Request (SRQ)	5-9
5-7. Sample Program : To Report Command Error Occurrence	5-11
5-8. Command-Error Bit Enabling	5-12
5-9. Sample Program : To Wait for Sweep End	5-14
5-10. Sweep-End Bit Enabling	5-14
6-1. Trigger System	6-1
6-2. Sample Program : To Trigger Measurements Continuously	6-2
6-3. Sample Program : To Trigger a Measurement from Controller (1)	6-3
6-4. Sample Program : To Trigger a Measurement from Controller (2)	6-4
6-5. Sample Program : Setting the Gate Trigger	6-5
7-1. 8-bit I/O Port	7-1
7-2. Sample Program : Synchronization of an External Handler with the Analyzer	7-2
7-3. 8-Bit Data of OUT0-7	7-2
7-4. Sending Signal to an the External Handler	7-2
7-5. Reading Signal from the External Handler	7-3
7-6. Write Strobe Signal Timing Chart	7-6
7-7. The Overview of 24-bit I/O Ports	7-8
7-8. 24-bit I/O port Connector Pin Number	7-8
8-1. Sample Program : Reading Data Using Marker Search Function	8-2
8-2. Marker on Trace	8-2
8-3. Sample Program : Limit Test (1/2)	8-5

8-4. Sample Program : List Sweep	8-8
8-5. Sample Program : To Observe Printing	8-10
8-6. Sample Program : 1 Pass 2 Port Calibration (1/2)	8-11
8-7. Conceptual View of a Bandpass-filtered Waveform	8-13
8-8. Sample Program : To Analyze a Filter (1/2)	8-14
8-9. Analyzing a Crystal Filter	8-17
8-10. Sample Program : Crystal Filter Analysis (1/4)	8-18
8-11. Gain Compression Measurement	8-22
8-12. Sample Program : Gain Compression Measurement (1/2)	8-22
8-13. Total Harmonic Distortion in a Signal	8-25
8-14. Sample Program : Total Harmonic Distortion (THD)	8-26
8-15. Integral Calculation of a Power	8-27
8-16. Sample Program : Integral Calculation of a Power (1/2)	8-27
8-17. Adjacent Channel Power	8-29
8-18. Sample Program : Adjacent Channel Power Calculation (1/2)	8-30
8-19. 99 % Occupied Power Bandwidth	8-32
8-20. Sample Program : Occupied Power Bandwidth Calculation (1/2)	8-32
8-21. Calculating an S/N ratio	8-34
8-22. Sample Program : Calculating an S/N ratio (1/3)	8-34
8-23. Sample Program : Calibration (1/2)	8-37
8-24. C-D Measurement	8-39
8-25. Sample Program : C-D Measurement (1/4)	8-39
8-26. Characteristic of a Varactor Diode	8-42
8-27. Sample Program : Measuring Varactor Diode Characteristic (1/3)	8-43
8-28. Sample Program: File Transfer from 4395A to External Controller (1/2)	8-47
8-29. Sample Program: File Transfer from External Controller to 4395A (1/2)	8-49
8-30. Sample Program: Displaying List of Files in Current Directory of 4395A	8-52
9-1. Sample Program : To Transfer the Program to IBASIC (on External Controller)	9-11
9-2. Sample Program : To Load HP Instrument BASIC Program Array (on External Controller)	9-12
9-3. Screen Structure	9-13
12-1. Serial Number Plate	12-2
K-1. Key Codes	K-1
R-1. Fixed length block format	R-2
R-2. Procedure of executing commands to read/write data	R-7

Tables

3-1. Calibration Types and Standard Classes	3-17
3-2. Calibration Array	3-18
5-1. Status Bit Definitions of the Status Byte (STB)	5-6
5-2. Status Bit Definitions of the Standard Event Status Register (ESR)	5-7
5-3. Status Bit Definitions of the Event Status Register B (ESB)	5-8
5-4. Status Bit Definitions of the Operation Status Register (OSR)	5-8
7-1. Assignment of Signals to Pins (Standard)	7-9
7-2. 24-bit I/O Port, Basic I/O Circuit	7-11
8-1. Marker Readout	8-4
12-1. Manual Changes by Serial Number	12-1
12-2. Manual Changes by Firmware Version	12-2

Introduction

Document Concepts and Usage

This manual provides an introduction to writing BASIC programs for the 4395A Network/Spectrum/Impedance Analyzer (analyzer). To reduce the time required for you to learn how to write programs for the analyzer, the examples shown in this guide are supplied on sample disks. You can perform each example sequentially or you can select the examples that apply to your immediate needs and learn those techniques. Use the table of contents and the index to quickly locate these examples.

Also, depending upon your experience in writing BASIC programs using GPIB commands, you may want to do one of the following:

1. If you are an experienced programmer and have programmed GPIB systems before, you can scan the examples in this guide to find out how the analyzer can be used in your system.
2. If you are not experienced in programming for GPIB instruments, we recommend you to read this manual from the beginning. Chapter 1 will help you greatly, providing programming basics.
3. Sample programs will give you a hint on how to use an GPIB command in your program. For detailed information on an GPIB command, see Chapter 11.
4. The 4395A provides the HP Instrument BASIC feature. If you use the HP Instrument BASIC for the first time, see Chapter 9 which describes the usage of the feature.

Overview of the GPIB Remote Control System

This chapter provides information on how to configure the GPIB remote-control system and the basic use of the GPIB commands. In the examples used in this manual, most of the commands are the simple GPIB commands. Note that no SCPI commands are available for the 4395A. Chapter 11 describes all the GPIB commands that are available for the 4395A.

What is GPIB?

The General Purpose Interface Bus (GPIB) is used for remote control of the 4395A Network/Spectrum Analyzer (analyzer). GPIB is a standard for interfacing instruments to computers and peripherals. This standard supports worldwide standards IEEE 488.1, IEC-625, and IEEE 488.2. The GPIB interface allows the analyzer to be controlled by an external computer. The computer sends commands or instructions to and receives data from the instrument through the GPIB.

Required Equipment

To perform the examples in this manual, you need the following equipment:

1. The analyzer and the accessories required to test a specific device under test (DUT).
2. For the GPIB system controller,



If the analyzer has the HP Instrument BASIC installed, it can be used as the system controller.

Or,



An HP Vectra PC with GPIB interface card (82341D etc.) or an HP 9000 Series 700 computer with GPIB interface card (E2071D etc.). For any computer, you need an GPIB control software, for example HP BASIC for windows. (You can use HP 9000 Series 200/300 computer, too).

3. Peripherals (printer, plotter, and so on) and any GPIB instruments that are required for your application.
4. 10833A/B/C/D GPIB cables to interconnect the computer, the analyzer, and any peripherals.

Controller

In the GPIB terminology, a *controller* is defined to be a device that can permit an GPIB device to *talk* (output data) or *listen* (receive incoming data).

When multiple controllers exist on an GPIB bus, only one of them can be active at a time and can control other devices on the bus. The active controller can issue a **PASS CONTROL** command to pass control to another controller in the same GPIB remote control system.

In a multiple-controller configuration, you can designate one of the controllers as the *system controller*. The system controller becomes active by default when the system power is turned ON. When another controller is serving as the active controller, the system controller can issue an **ABORT select code** to become the active controller at any time.

Device Selector

The active controller can control any of the connected GPIB devices. To select which GPIB device to put under its control, the active controller uses the device selector mapped to that target device. Then, the active controller can send various commands to control the behavior or activity of the target device.

1. Use GPIB cables to connect the 4395A with controllers (computers) and peripherals.

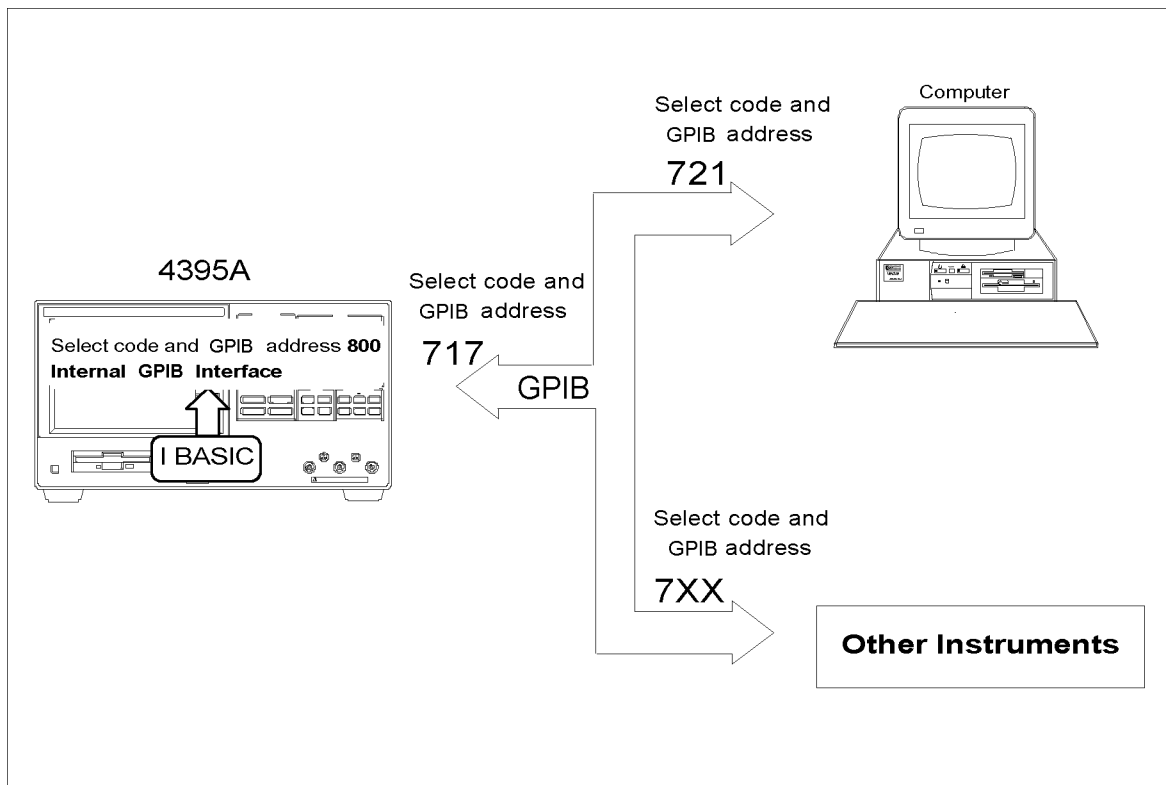

Figure 1-1. Configuration of an GPIB Remote Control System

Figure 1-1 illustrates how GPIB addresses are mapped to device selectors. For example, a printer whose GPIB address is “1” is mapped to device selector “701”.

The HP Instrument BASIC feature is internally connected to the 4395A via the built-in interface. The interface select code for the built-in interface is defined as “8.” Thus it is distinguished from the external select code “7.”

From HP Instrument BASIC, any address ranging from “00” to “30” can be used to designate the analyzer, which is only the device that is connected to the built-in interface. Throughout this manual, the address “00” is always used for the analyzer so that its device selector is “800.”

How large a system can you configure?

- maximum of 15 devices can be connected on one bus system.
- The length of cable between one device and another must be less than or equal to four meters. The total length of cable in one bus system must be less than or equal to two meters times the number of devices connected on the bus (the GPIB controller counts as one device). The total length of cable must not exceed 20 meters
- Star, linear, and combinational cable configurations are allowed. There must be no loop.

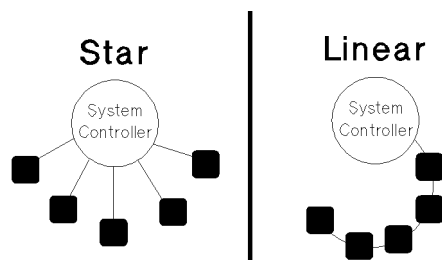

- It is recommended that no more than four piggyback connectors be stacked together on one device. Otherwise, the resulting structure could exert enough force on the connector mounting to damage it.

Writing and Running Programs

Easy Program Writing

This section serves a simple programming example, which describes procedures required to write and run a program using HP Instrument BASIC. See Chapter 9 for general description of the HP Instrument BASIC and its usage. You can also type in the program without using the BASIC feature.

In this example, the 4395A is set to the condition shown below:

ACTIVE CHANNEL Block	Channel 1 (Default)
MEASUREMENT Block	Network Analyzer A/R LOG MAG Format (Default) Display Scale : Auto
SWEEP Block	Center Frequency : 70MHz Span Frequency : 100kHz

This example requires no keyboard operation; all the procedure can be done by pressing the keys on the front panel.

1. Turn ON the 4395A
2. Press the key and softkeys as shown below to display the softkeys for the network analyzer.

Meas ANALYZER TYPE NETWORK ANALYZER

3. Press

System IBASIC Edit

The system goes to the edit mode. The cursor is located at the line 10.

```
10 _
```

4. Press

ASSIGN Hp4395

This brings the command below at the cursor.

```
10 ASSIGN Hp4395 TO 800_
```

5. Press

x1

This confirms the entry of a command and the cursor moves to the next line.

```
10 ASSIGN Hp4395 TO 800
20 -
```

6. Press

OUTPUT Hp4395

You will see the following character strings on the screen:

```
10 ASSIGN Hp4395 TO 800
20 OUTPUT Hp4395""
```

7. Press the key shown below to enter the preset command.

Preset

At the cursor displayed is the GPIB command “;PRES” which presets an instrument.

```
10 ASSIGN Hp4395 TO 800
20 OUTPUT Hp4395";PRES"
```

Then press **x1**.

Note



If you place more than one command in a OUTPUT statement, they should be delimited using “;”. The delimiter is automatically inserted when you enter GPIB commands with the keys on the front panel.

8. Press the key and softkeys as shown below to specify the measurement parameter to A/R.

OUTPUT Hp4395 **Meas** **ANALYZER TYPE NETWORK ANALYZER** **RETURN A/R**

This generates the program code as follows:

```
10 ASSIGN Hp4395 TO 800
20 OUTPUT Hp4395";PRES "
30 OUTPUT Hp4395";NA;MEAS AR"
```

Then press **x1**.

9. Press the key and softkeys as shown below to specify the center and span frequencies.

System **IBASIC** **OUTPUT Hp4395** **Cent** **7** **0** **M/μ** **Span** **1** **0** **0** **k/m** **x1**

```
10 ASSIGN Hp4395 TO 800
20 OUTPUT Hp4395;" ;PRES"
30 OUTPUT Hp4395;" ;NA;MEAS AR"
40 OUTPUT Hp4395;" ;CENT 70E6;SPAN 100E3"
50 -
```

10. Press the key and softkeys as shown below to auto-scaling.

System **IBASIC** **OUTPUT Hp4395** **Scale Ref** **AUTO SCALE** **x1**

```
10 ASSIGN Hp4395 TO 800
20 OUTPUT Hp4395;" ;PRES"
30 OUTPUT Hp4395;" ;NA;MEAS AR"
40 OUTPUT Hp4395;" ;CENT 70E6;SPAN 100E3"
50 OUTPUT Hp4395;" ;AUTO"
60 -
```

11. Enter END command to end the program.

System **IBASIC** **END** **x1**

```
10 ASSIGN Hp4395 TO 800
20 OUTPUT Hp4395;" ;PRES"
30 OUTPUT Hp4395;" ;NA;MEAS AR"
40 OUTPUT Hp4395;" ;CENT 70E6;SPAN 100E3"
50 OUTPUT Hp4395;" ;AUTO"
60 END
70 -
```

12. Press the key below to exit the edit mode.

END EDIT

The LCD switches back to the measurement results.

Note



HP Instrument BASIC cannot be used to program certain operations, such as the procedures for calibration.

Running (Executing) Programs

Press the following key and softkeys from the front panel to execute the program:

System **IBASIC** **Run**

The system executes the program. You can execute the **RUN** statement from the keyboard. Type and press as follows:

RUN **Enter**

Saving Programs

Simple procedure for saving a program is shown here. See “Saving Programs (SAVE)” in Chapter 9 for details.

1. Connect the keyboard to the 4395A
2. Press the keys and softkeys as shown below to switch the screen area allocation.

Display **MORE** **DISPLAY ALLOCATION** **ALL BAISC**

3. Select the storage device where you wish to save your program.

System **IBASIC** **MORE** **MSI[]**

4. In the key sequence above, choose **[INTERNAL]** to save the program on a floppy disk or **[MEMORY]** on the memory disk.
5. Press the keys and softkeys as shown below.

System **IBASIC** **MORE** **SAVE**

This gives:

SAVE ""

6. From the keyboard, type in a file name you want to use. Note that the **SAVE** command does not work if any file that has the same name already resides in the storage. In this case, use a different name or overwrite the file with **RE-SAVE** command.

Retrieving a Program You Saved

1. Press the keys and softkeys as shown below to switch the screen area allocation.

Display **MORE** **DISPLAY ALLOCATION** **ALL BAISC**

2. Select the storage device which stores the file you wish to retrieve.

System **IBASIC** **MORE** **MSI[]**

3. Press

System **IBASIC** **MORE** **GET**

4. From the keyboard, type in the file name.
5. Use **CAT** command to list the names of files, if you are not certain an exact name of the file.

Programming Measurement Sequence

This chapter provides basic procedures required for programming a measurement sequence. The chapter covers:

- GPIB Commands Overview
- To Program a Basic Measurement

GPIB Commands Overview

All the analyzer's front-panel keys have a corresponding GPIB command. By executing a GPIB command, you can operate the analyzer as if you were pressing the corresponding key.

For example, Pressing **Preset** is the same as executing the GPIB command, **PRES**.

Sending a GPIB Command

Combine the BASIC **OUTPUT** statement with the GPIB select code, the device address, and finally the analyzer command. For example, to execute **PRES** command, type:



Using HP Instrument BASIC

```
OUTPUT 800;"PRES"
```

↑ ↑
Select code GPIB address *
(internal GPIB interface)

* You can set any GPIB address up to 31

And press **Return**. The analyzer goes to the preset state.



Using an External Controller

```
OUTPUT 717;"PRES"
```

↑ ↑
Select code GPIB address (same number as you set in page 1-2.)

And press **Return**. The analyzer is set to GPIB remote mode. Then the analyzer goes to the preset state.

What is GPIB remote mode?



Executing an `OUTPUT` statement that is addressed to the analyzer, sets it to the GPIB remote mode. In the remote mode, all the analyzer's front-panel keys are locked out, except `(Local)`. Pressing `(Local)` puts the analyzer back in local mode. In local mode, all front-panel keys are enabled.

Note



In the above example, the `OUTPUT` statement can be written as follows if you use it with an `ASSIGN` statement:

```
ASSIGN @Hp4395 TO 800
OUTPUT @Hp4395;"PRES"
```

This style might make modification of a program easier, depending how your program is organized.

To Execute an GPIB Command with a Parameter

Some GPIB commands require a numeric parameter. For example:

```
OUTPUT @Hp4395;"CENT 25000000" ! Set center frequency to 25 MHz.
```

(The space between the command and the numeric parameter is mandatory.)

You can program it to be entered each time the program is run. For example:

```
100 INPUT "Enter center frequency(Hz).";F_cent
110 OUTPUT @Hp4395;"CENT ";F_cent
```

Executing this gives you:

```
Enter center frequency (Hz).
25000000
```

The analyzer's center frequency is set to 25 MHz.

To Execute a Query

A query command is a command that inquires an instrument information such as measurement data. In general, a query command is used in an `OUTPUT` statement with an `ENTER` statement associated. Note that executing a query command does not always result in a single numerical value; it may contain multiple values or character strings. See Chapter 11 for details.

```
10 OUTPUT @Hp4395;"CENTS?"
20 ENTER @Hp4395;A
```

Any GPIB command that is used with a numeric parameter can also be used as a query command. For example, the `CENT numeric_parameter` command used in the previous example, can be combined with a `?`, and used as a query command as follows,

```
10 OUTPUT @Hp4395;"CENT?"
20 ENTER @Hp4395;A
30 PRINT A
```

A query command is used mostly in an OUTPUT statement followed by an ENTER statement; the OUTPUT statement sends the query command to the 4395A and the ENTER statement receives a return value from the analyzer.

The CENT? command returns the current center frequency, which is put into A. Executing this program results in the following:

```
25000000
```

By interrogating the analyzer to determine the values of the start and stop frequencies, or the center frequency and frequency span, the computer can keep track of the actual frequencies.

To Program a Basic Measurement

This section describes how to organize the commands into a measurement sequence.

Figure 2-1 shows a typical program flow for a measurement.

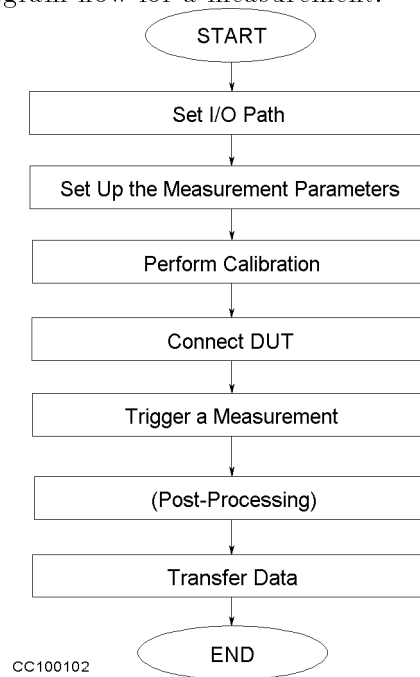

Figure 2-1. Program Flow

The following program performs the measurement flow controlling the analyzer using GPIB.



This guide shows program lists of sample programs for an external controller. To use the sample programs in this guide with HP Instrument BASIC, change the select code from 7 to 8 and change the GPIB address from 17 to 00 (that is, use 800 instead of 717).

```
10 !
20 !Fig.2-2 Basic Measurement
30 !
40 ASSIGN @Hp4395 TO 717 ! When iBASIC is used, change "717" to "800".
50 !
60 OUTPUT @Hp4395;"PRES" ! Preset 4395A
70 OUTPUT @Hp4395;"CHAN1;NA;MEAS S21;FMT LOGM"
80 INPUT "Enter center frequency (Hz).",F_cent
90 INPUT "Enter frequency span (Hz).",F_span
100 OUTPUT @Hp4395;"CENT ";F_cent
110 OUTPUT @Hp4395;"SPAN ";F_span
120 !
130 ! Frequency Response Calibration
140 OUTPUT @Hp4395;"CALK N50" ! Select 50 ohm type-N Cal. kit
150 OUTPUT @Hp4395;"CALI RESP" ! Select Response cal.
160 OUTPUT @Hp4395;"CLES" ! Clear all status
170 INPUT "Connect THRU, then press [Enter].",Dum$
180 OUTPUT @Hp4395;"*SRE 4;ESNB 1" ! Set enable STB and ESB
```

Figure 2-2. Sample Program : Basic Measurement (1/2)

```

190  ON INTR 7 GOTO Cal_end      ! \ When iBASIC is used, change "7" to "8".
200  ENABLE INTR 7;2            ! /
210  OUTPUT @Hp4395;"STANC"      ! Measure THRU
220  Calibrating:      GOTO Calibrating
230  Cal_end:          !
240  OUTPUT @Hp4395;"RESPDONE"    ! Calculating cal coefficients
250  OUTPUT @Hp4395;"*OPC?"      ! \ Waiting calculation end
260  ENTER @Hp4395;Dum          ! /
270  DISP "Response cal completed."
280  !
290  ! Measurement
300  INPUT "Connect DUT, then press [Enter].",Dum$
310  OUTPUT @Hp4395;"CLES"      ! Clear all status registers
320  OUTPUT @Hp4395;"*SRE 4;ESWB 1"
330  ON INTR 7 GOTO Sweep_end    ! \ When iBASIC is used,
340  ENABLE INTR 7;2            ! / change "7" to "8"
350  OUTPUT @Hp4395;"SING"      ! Sweep mode is SINGLE
360  Measuring:      GOTO Measuring
370  Sweep_end:        !
380  OUTPUT @Hp4395;"MKR ON"     ! Marker 1 ON
390  OUTPUT @Hp4395;"SEAM MAX"   ! Search MAX
400  OUTPUT @Hp4395;"OUTPMKR?"  ! Output marker value
410  ENTER @Hp4395;Val1,Val2,Swp
420  PRINT "Max val:",Val1;"dB"
430  PRINT "Swp.Prmtr:",Swp;"Hz"
440  END

```

Figure 1-3. Sample Program : Basic Measurement (2/2)

Set I/O Path

```

40  ASSIGN @Hp4395 TO 717      ! When iBASIC is used, change "717" to "800".

```

This operation allows you to use @Hp4395, instead of 717(or 800), as the GPIB address in the program.

Set Up the Measurement Parameters

```

60  OUTPUT @Hp4395;"PRES"
70  OUTPUT @Hp4395;"CHAN1;NA;MEAS S21;FMT LOGM"
80  INPUT "Enter center frequency (Hz).",F_cent
90  INPUT "Enter frequency span (Hz).",F_span
100 OUTPUT @Hp4395;"CENT ";F_cent
110 OUTPUT @Hp4395;"SPAN ";F_span

```

You can execute GPIB commands in the same sequence as key operation. Lines 60 and 70 perform the same operation as pressing **Preset** **Chan 1** **Meas** **ANALYZER TYPE** **NETWORK ANALYZER S PARAMETERS** **Trans:FDW S21 [B/R]** **Format** **LOG MAG**.

In general, the procedure for setting up measurements on the analyzer via GPIB follows the same sequence as performing the procedure manually. There is no required order, as long as the desired frequency range, number of points, and power level are set before performing the calibration.

In line 70, several GPIB commands, separated by semicolon, are executed in a line. This is the same as:

```

70  OUTPUT @Hp4395;"CHAN1"
71  OUTPUT @Hp4395;"NA"
72  OUTPUT @Hp4395;"MEAS S21"
73  OUTPUT @Hp4395;"FMT LOGM"

```

In lines 80 to 110 (setting frequency), parameters are required with the GPIB command. To set parameters, see “To Execute an GPIB Command with a Parameter” later in this chapter.

Perform Calibration

```

130  ! Frequency Response Calibration
140  OUTPUT @Hp4395;"CALK N50"      ! Select 50 ohm type-N Cal. kit
150  OUTPUT @Hp4395;"CALI RESP"    ! Select Response cal.
160  OUTPUT @Hp4395;"CLES"        ! Clear all status
170  INPUT "Connect THRU, then press [Return].",Dum$
180  OUTPUT @Hp4395;"*SRE 4;ESNB 1" ! Set enable STB and ESB
190  ON INTR 7 GOTO Cal_end        ! \ When iBASIC is used, change "7" to "8".
200  ENABLE INTR 7;2              ! /
210  OUTPUT @Hp4395;"STANC"        ! Measure THRU
220  Calibrating:      GOTO Calibrating
230  Cal_end:         !
240  OUTPUT @Hp4395;"RESPDONE"    ! Calculating cal coefficients
250  OUTPUT @Hp4395;"*0PC?"      ! \ Waiting calculation end
260  ENTER @Hp4395;Dum           ! /
270  DISP "Response cal completed."

```

In lines 140 to 240, the GPIB program follows the key strokes required to calibrate from the front panel. This program performs a response calibration.

Line 170 requests the operator to connect a THRU calibration standard.

Lines 180 through 220 use the status bytes to detect the completion of the THRU calibration. See “To Wait for Sweep End” in Chapter 5.

All the setting and calibration procedures are completed. Now you can start measuring your DUT.

Connect DUT

```

300  INPUT "Connect DUT, then press [Enter].",Dum$

```

Line 300 requests the operator to connect a DUT to the analyzer.

Trigger a Measurement

```

310  OUTPUT @Hp4395;"CLES"      ! Clear all status registers
320  OUTPUT @Hp4395;"*SRE 4;ESNB 1"
330  ON INTR 7 GOTO Sweep_end    ! \ When iBASIC is used,
340  ENABLE INTR 7;2            ! / change "7" to "8"
350  OUTPUT @Hp4395;"SING"      ! Sweep mode is SINGLE
360  Measuring:      GOTO Measuring
370  Sweep_end:     !

```

Lines 310 to 370 enable SRQ interruption for sweep end detection. For details, see “To Wait for Sweep End” in Chapter 5.

2-6 Programming Measurement Sequence

In line 350, the analyzer executed a single trigger. For more advanced trigger control, see Chapter 6.

Post-Processing

```
380  OUTPUT @Hp4395;"MKR ON"      ! Marker 1 ON
390  OUTPUT @Hp4395;"SEAM MAX"    ! Search MAX
```

Line 380 activates the marker and line 390 moves the marker to the maximum value on the trace. For details on using the marker, see Chapter 3.

Transfer Data

```
400  OUTPUT @Hp4395;"OUTPMKR?"  ! Output marker value
410  ENTER  @Hp4395;Val1,Val2,Swp
```

The measured data is transferred to the controller. For details about data transfer, see Chapter 3.

Processing and Transferring Data

This chapter illustrates how to transfer and receive data stored in the 4395A between the controller via GPIB.

Measurement data can be read out of the analyzer in the following ways:

1. The entire trace (or data for a specified number of points) can be read out in the following ways:
 - Data arrays — In regard to the data processing flow, the following data arrays are available.

RAW DATA ARRAYS
 CALIBRATION COEFFICIENT ARRAYS
 DATA ARRAYS
 MEMORY ARRAYS
 DATA TRACE ARRAYS
 MEMORY TRACE ARRAYS

Note



When you transfer these data to 4395A, set 4395A's configuration the same way as when you received data. Without this, you will be unable to measure correct data. Be sure to set up CALIBRATION COEFFICIENT ARRAYS.

- Data format — The analyzer provides four data transfer formats.

FORM2 IEEE 32 bit floating point format
 FORM3 IEEE 64 bit floating point format
 FORM4 ASCII format
 FORM5 MS-DOS® personal computer format

Depending on the format, the data transfer speed and the number of digits are changed. Generally, binary data transfer (FORM2, FORM3, or FORM5) is faster than ASCII (FORM4).

2. Data can be read off the trace selectively using the markers.

The present value of the marker (real-imaginary data and sweep parameter) is retrieved. For additional information on the marker functions, see Chapter 8.

Data Processing Flow

This section gives an overview of the data processing flow in the 4395A and describes commands to write data in the data arrays.

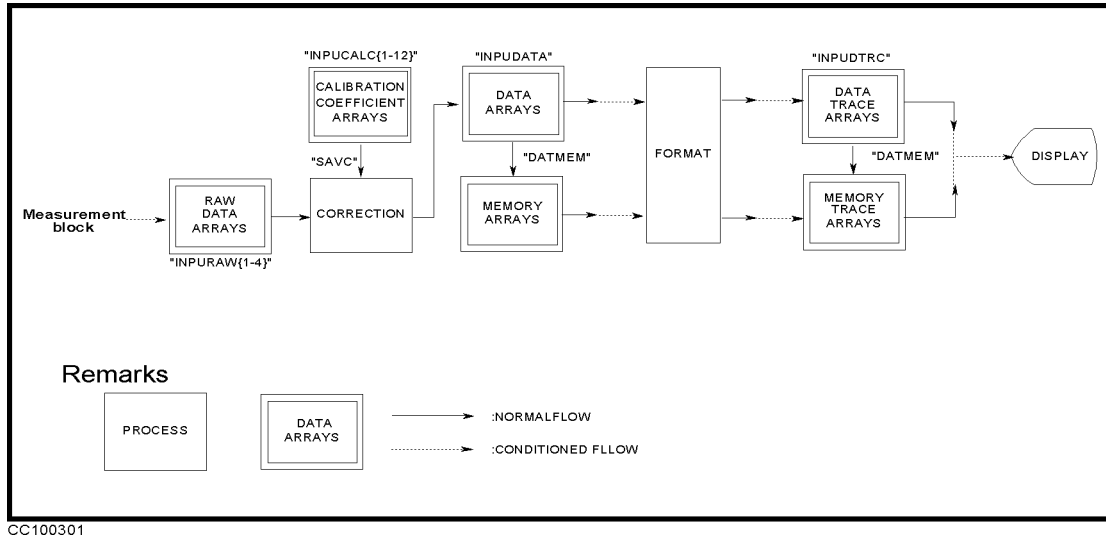

CC100301

Figure 3-1. Data Arrays, Data Processing, and GPIB Command

- Reset command

*RST or PRES command clears all arrays.

- Data array writing command

INPURAW{1-4}, INPUDATA and INPUDTRC commands write the corresponding arrays. These commands immediately reshape the data trace on the analyzer's display.

INPUCALC{1-12} commands write the CALIBRATION COEFFICIENT ARRAYS.

- DATA to MEMORY command

DATMEM command restores the contents in DATA ARRAYS into MEMORY ARRAYS, and the contents in DATA TRACE ARRAYS into MEMORY TRACE ARRAYS.

- Data processing command

SAVC command executes the data processing CORRECTION with the current RAW ARRAYS and CALIBRATION COEFFICIENT ARRAYS.

The following examples show how to modify the DATA ARRAYS and DATA TRACE ARRAYS. See "Data Levels" for further information on the data arrays in Figure 3-1.

3-2 Processing and Transferring Data

To Modify Calibration Data

```
10      !
11      !
12      !Fig.3-2 To Modify Calibration Data
13      !
14      !
15      ASSIGN @Hp4395 TO 717 ! When iBASIC is used, change "717" to "800"
16      !
17      !
18      OUTPUT @Hp4395;"PRES"
19      OUTPUT @Hp4395;"NA"
20      INPUT "Enter center frequency(Hz).",F_cent
21      INPUT "Enter frequency span(Hz).",F_span
22      OUTPUT @Hp4395;"CENT ";F_cent
23      OUTPUT @Hp4395;"SPAN ";F_span
24      OUTPUT @Hp4395;"HOLD"
25      !
26      ! Calibration
27      OUTPUT @Hp4395;"CLES"
28      OUTPUT @Hp4395;"*SRE 4;ESNB 1" ! Set enable STB and ESB
29      INPUT "Connect THRU and press [RETURN] to do CAL.",Dum$
30      OUTPUT @Hp4395;"CALI RESP"
31      ON INTR 7 GOTO Cal_end ! \ When iBASIC is used,
32      ENABLE INTR 7;2 ! / change "7" to "8"
33      OUTPUT @Hp4395;"STANC" ! Measure THRU
34      Calibrating:GOTO Calibrating
35      Cal_end: !
36      OUTPUT @Hp4395;"RESPDONE" ! Calculating cal coefficient
37      OUTPUT @Hp4395;"*OPC?" ! \ Wait until calculating ends
38      ENTER @Hp4395;Dum ! /
39      DISP "Calibration Complete"
40      !
41      ! Read Calibration Data
42      DIM Dat(1:801,1:2) ! When iBASIC is used, change "801" to "802"
43      OUTPUT @Hp4395;"POIN?" ! \
44      ENTER @Hp4395;Nop ! | When iBASIC is used,delete these lines
45      REDIM Dat(1:Nop,1:2) ! /
46      ASSIGN @Dt TO 717;FORMAT OFF ! When iBASIC is used,
47      OUTPUT @Hp4395;"FORM3" ! change "717" to "800"
48      OUTPUT @Hp4395;"OUTPCALC1?"
49      ENTER @Dt USING "%,8A";Head$
50      ENTER @Dt;Dat(*)
51      ENTER @Dt USING "%,1A";Dum$ ! When iBASIC is used, delete this line
52      400 !
53      ! Modify Calibration Data
54      420 !
55      ! Restore Calibration Data
56      OUTPUT @Hp4395;"INPUCALC1 ";
57      OUTPUT @Dt USING "#,8A";Head$
58      OUTPUT @Dt;Dat(*),END
59      ASSIGN @Dt TO *
60      OUTPUT @Hp4395;"SAVC" ! Redraw Trace
61      490
62      END
```

Figure 3-2. Sample Program : To Modify Calibration Data

This program measures calibration standards, reads the obtained calibration data, and restores the data in the analyzer.

Read Error-Corrected Data

```
290      ! Read Calibration Data
300      DIM Dat(1:801,1:2)      ! When iBASIC is used, change "801" to "802"
310      OUTPUT @Hp4395;"POIN?"
320      ENTER @Hp4395;Nop
330      REDIM Dat(1:Nop,1:2)      ! | When iBASIC is used, delete these lines
340      ASSIGN @Dt TO 717;FORMAT OFF
350      OUTPUT @Hp4395;"FORM3"
360      OUTPUT @Hp4395;"OUTPCALC1?"
370      ENTER @Dt USING "%,8A";Head$
380      ENTER @Dt;Dat(*)
390      ENTER @Dt USING "%,1A";Dum$ ! | When iBASIC is used, delete these lines
```

The controller can read out the error coefficients using the GPIB commands `OUTPCALC{1-12}`. Each point is a real/imaginary pair, and the number of points in the array is the same as the number of points in the sweep. For details on data transfer, see Chapter 3.

Each calibration type uses only as many arrays as needed, starting with array 1, and each array stores a specific error coefficient. Therefore, it is necessary to know the type of calibration about to be read out: attempting to read an array not being used in the current calibration causes the “REQUESTED DATA NOT CURRENTLY AVAILABLE” warning to be displayed. For assignment of data arrays, see “Calibration Types and Standard Classes, and Calibration Arrays” in this chapter.

Modify Calibration Data

```
400      !
410      !   Modify Calibration Data
420      !
```

In this portion of program, you modify the CALIBRATION COEFFICIENT ARRAY, which is contained in `Dat(1:801,1:2)`.

Restore Modified Calibration Data

```
430      !   Restore Calibration Data
440      OUTPUT @Hp4395;"INPUCALC1 ";
450      OUTPUT @Dt USING "#,8A";Head$
460      OUTPUT @Dt;Dat(*),END
```

Line 440 opens the CALIBRATION COEFFICIENT ARRAY 1 in the analyzer. This array is used to restore the data.

Lines 450 and 460 send the file header (`Head$`), calibration data (`Dat(*)`) and the terminator (`END`). The file header is an input in line 370.

This example sets the trigger to `HOLD` at line 120. The analyzer does not redraw the trace with the new CALIBRATION COEFFICIENT ARRAYS when the trigger is set to `HOLD`. You can redraw the trace by issuing the GPIB command `SAVC`.

To Modify Error-Corrected Data

```
10      !
11      !
12      ! Fig.3-3 To Modify Error-Corrected Data
13      !
14      !
15      ASSIGN @Hp4395 TO 717 ! When iBASIC is used, change "717" to "800"
16      !
17      !
18      OUTPUT @Hp4395;"PRES"
19      OUTPUT @Hp4395;"NA"
20      INPUT "Enter center frequency(Hz).",F_cent
21      INPUT "Enter frequency span(Hz).",F_span
22      OUTPUT @Hp4395;"CENT ";F_cent
23      OUTPUT @Hp4395;"SPAN ";F_span
24      !
25      INPUT "Connect DUT and press [RETURN].",Dum$
26      OUTPUT @Hp4395;"CLES"
27      OUTPUT @Hp4395;"*SRE 4;ESNB 1" ! Set enable STB and ESB
28      ON INTR 7 GOTO Sweep_end ! \ When iBASIC is used,
29      ENABLE INTR 7;2 ! / change "7" to "8"
30      OUTPUT @Hp4395;"SING"
31      Measuring: GOTO Measuring
32      Sweep_end: !
33      DISP "Measurement Complete"
34      !
35      ! Read Error-Corrected Data
36      DIM Dat(1:801,1:2) ! When iBASIC is used, change "801" to "802"
37      OUTPUT @Hp4395;"POIN?" ! \
38      ENTER @Hp4395;Nop ! | When iBASIC is used, delete these lines
39      REDIM Dat(1:Nop,1:2) ! /
40      ASSIGN @Dt TO 717;FORMAT OFF ! When iBASIC is used,
41      OUTPUT @Hp4395;"FORM3" ! change "717" to "800"
42      OUTPUT @Hp4395;"OUTPDATA?"
43      ENTER @Dt USING "%,8A";Head$
44      ENTER @Dt;Dat(*)
45      ENTER @Dt USING "%,1A";Dum$ ! When iBASIC is used, delete this line
46      !
47      ! Modify Error-Corrected Data
48      !
49      ! Restore Error-Corrected Data
50      OUTPUT @Hp4395;"INPUDATA ";
51      OUTPUT @Dt USING "#,8A";Head$
52      OUTPUT @Dt;Dat(*),END
53      ASSIGN @Dt TO *
54      END
```

Figure 3-3. Sample Program : To Modify Error-Corrected Data

This program measures the DUT, reads the obtained data, and restores the data in the analyzer.

Read Error-Corrected Data

```
230  ! Read Error-Corrected Data
240  DIM Dat(1:801,1:2)  ! When iBASIC is used, change "801" to "802"
250  OUTPUT @Hp4395;"POIN?"  ! \
260  ENTER @Hp4395;Nop      ! | When iBASIC is used, delete these lines
270  REDIM Dat(1:Nop,1:2)  ! /
280  ASSIGN @Dt TO 717;FORMAT OFF  ! When iBASIC is used,
290  OUTPUT @Hp4395;"FORM3"      ! change "717" to "800"
300  OUTPUT @Hp4395;"OUTPDATA?"
310  ENTER @Dt USING "%,8A";Head$
320  ENTER @Dt;Dat(*)
330  ENTER @Dt USING "%,1A";Dum$  ! When iBASIC is used, delete this line
```

OUTPDATA? command retrieves DATA ARRAYS in the analyzer.

Restore Modified Error-Corrected Data

```
370  ! Restore Error-Corrected Data
380  OUTPUT @Hp4395;"INPUDATA ";
390  OUTPUT @Dt USING "#,8A";Head$
400  OUTPUT @Dt;Dat(*),END
```

Line 380 opens the DATA ARRAYS in the analyzer to restore the data.

Lines 390 to 400 transfer data in FORM3 (a similar procedure is used in the "To Modify Calibration Data" example).

To Modify Trace Data

```
10      !
20      !Fig.3-4 To Modify Trace Data
30      !
40      ASSIGN @Hp4395 TO 717 ! When iBASIC is used, change "717" to "800"
50      !
60      OUTPUT @Hp4395;"PRES"
70      OUTPUT @Hp4395;"NA"
80      INPUT "Enter center frequency(Hz).",F_cent
90      INPUT "Enter frequency span(Hz).",F_span
100     OUTPUT @Hp4395;"CENT ";F_cent
110     OUTPUT @Hp4395;"SPAN ";F_span
120     !
130     INPUT "Connect DUT and press [RETURN].",Dum$
140     OUTPUT @Hp4395;"CLES"
150     OUTPUT @Hp4395;"*SRE 4;ESNB 1" ! Set enable STB and ESB
160     ON INTR 7 GOTO Sweep_end ! \ When iBASIC is used,
170     ENABLE INTR 7;2 ! / change "7" to "8"
180     OUTPUT @Hp4395;"SING"
190     Measuring: GOTO Measuring
200     Sweep_end: !
210     DISP "Measurement Complete"
220     !
230     ! Read Trace Data
240     DIM Dat(1:801,1:2) ! When iBASIC is used, change "801" to "802"
250     OUTPUT @Hp4395;"POIN?" ! \
260     ENTER @Hp4395;Nop ! | When iBASIC is used, delete these lines
270     REDIM Dat(1:Nop,1:2) ! /
280     ASSIGN @Dt TO 717;FORMAT OFF ! When iBASIC is used,
290     OUTPUT @Hp4395;"FORM3" ! change "717" to "800"
300     OUTPUT @Hp4395;"OUTPDTRC?"
310     ENTER @Dt USING "%,8A";Head$
320     ENTER @Dt;Dat(*)
330     ENTER @Dt USING "%,1A";Dum$ ! When iBASIC is used, delete this line
340     !
350     ! Modify Trace Data
360     !
370     ! Restore Trace Data
380     OUTPUT @Hp4395;"INPUDTRC ";
390     OUTPUT @Dt USING "#,8A";Head$
400     OUTPUT @Dt;Dat(*),END
410     ASSIGN @Dt TO *
420     END
```

Figure 3-4. Sample Program : To Modify Trace Data

This program measures the DUT, reads the obtained data, and restores the data into the analyzer. For details on how to read the data array, see Chapter 3.

For details on how to modify the trace on the display, see the “To Modify Calibration Data” example.

Read Trace Data

```
230  !   Read Trace Data
240  DIM Dat(1:801,1:2)  ! When iBASIC is used, change "801" to "802"
250  OUTPUT @Hp4395;"POIN?"  ! \
260  ENTER @Hp4395;Nop      ! | When iBASIC is used, delete these lines
270  REDIM Dat(1:Nop,1:2)  ! /
280  ASSIGN @Dt TO 717;FORMAT OFF  ! When iBASIC is used,
290  OUTPUT @Hp4395;"FORM3"      ! change "717" to "800"
300  OUTPUT @Hp4395;"OUTPDTRC?"
310  ENTER @Dt USING "%,8A";Head$
320  ENTER @Dt;Dat(*)
330  ENTER @Dt USING "%,1A";Dum$  ! When iBASIC is used, delete this line
```

The OUTPDTRC? command (line 300) retrieves trace data in the analyzer. For details on data transfer, see “To Get Measurement Data Using ASCII Format” and Figure 3-6.

Restore Modified Trace Data

```
370  !   Restore Trace Data
380  OUTPUT @Hp4395;"INPU DTRC ";
390  OUTPUT @Dt USING "#,8A";Head$
400  OUTPUT @Dt;Dat(*),END
```

Line 380 opens the DATA TRACE ARRAYS in the analyzer to restore the data.

Lines 390 and 400 transfer data in FORM3 (a similar procedure is used in the “To Modify Calibration Data” example).

To Get Measurement Data Using ASCII Format

This section provides procedures required for getting data using ASCII format, taking a measurement trace as an example.

```
10      !
20      !Fig.3-5 To Get Measurement Trace Using ASCII Format
30      !
40      ASSIGN @Hp4395 TO 717 ! When iBASIC is used, change "717" to "800"
50      !
60      INPUT "ENTER CENTER FREQUENCY (Hz)",F_cent
70      INPUT "ENTER FREQUENCY SPAN (Hz)",F_span
80      OUTPUT @Hp4395;"CENT";F_cent
90      OUTPUT @Hp4395;"SPAN";F_span
100     !
110     OUTPUT @Hp4395;"CLES"
120     OUTPUT @Hp4395;"*SRE 4;ESNB 1"
130     ON INTR 7 GOTO Sweep_end ! \ When iBASIC is used, change "7" to "8"
140     ENABLE INTR 7;2          ! /
150     OUTPUT @Hp4395;"SING"    ! Trigger a Measurement
160     Measuring: GOTO Measuring ! Measuring
170     Sweep_end: !
180     DIM Dat(1:801,1:2),Swp(1:801) ! For spectrum measurement, change
190     OUTPUT @Hp4395;"FORM4"    ! "Dat(1:801,1:2)" to "Dat(1:801)"
200     OUTPUT @Hp4395;"OUTPDTRC?"
210     ENTER @Hp4395 USING "%,K";Dat(*)
220     OUTPUT @Hp4395;"OUTPSWPRM?"
230     ENTER @Hp4395 USING "%,K";Swp(*)
240     !
250     OUTPUT @Hp4395;"POIN?"
260     ENTER @Hp4395;Nop
270     FOR I=1 TO Nop
280         PRINT Swp(I);"Hz",Dat(I,1);"dB" ! For spectrum measurement, change
290     NEXT I                          ! "Dat(I,1)" to "Dat(I)"
300     END
```

Figure 3-5. Sample Program : To Get Measurement Trace Using ASCII Format

Set the Receive Array

```
180     DIM Dat(1:801,1:2),Swp(1:801)
```

Line 180 sets the array size to the analyzer's maximum number of measurement points (801).

In this example, it is assumed that the analyzer is in the network analyzer mode of operation, in which each point has complex data. If you use the analyzer in the spectrum analyzer mode, each measurement point has only real data, so you must set the data array `Dat` as follows:

```
180     DIM Dat(1:801),Swp(1:801)
280     PRINT Swp(I);"Hz",Dat(I);"dB"
```

If the number of measurement points changes, then so does the number of data. You must control the number of entered measurement data (see lines 210 and 230).

Set Data Transfer Format

```
190      OUTPUT @Hp4395;"FORM4"
```

Line 190 tells the analyzer to use the ASCII transfer format.

Read Data

```
200      OUTPUT @Hp4395;"OUTPDTRC?"
210      ENTER @Hp4395 USING "%,K";Dat(*)
220      OUTPUT @Hp4395;"OUTPSWPRM?"
230      ENTER @Hp4395 USING "%,K";Swp(*)
```

OUTPDTRC? retrieves DATA TRACE ARRAYS, and OUTPSWPRM? retrieves sweep parameters.

In line 210 and 230, you must choose %,K to allow for an insufficient number of data points to fill the array (which is 801 as declared in line 180).

What are other data arrays?

You can retrieve the following data arrays, exchanging GPIB command **OUTPDTRC?** in line 200. For details on each command, see Chapter 11.

- RAW DATA ARRAYS **OUTPRAW{1-4}?**
- DATA ARRAYS **OUTPDATA?**
- MEMORY ARRAYS **OUTPMEMO?**
- MEMORY TRACE ARRAYS **OUTPMTRC?**
- CALIBRATION COEFFICIENT ARRAYS **OUTPCALC{1-12}?**

To Get Measurement Trace Using Binary Format

This section provides procedures required for getting data using binary format, taking a measurement trace as an example.

Before running the program in Figure 3-6, you must modify the dimension of the data arrays to match to the analyzer type (network or spectrum). (See the "Set the Receive Array" example.)

```
10 !
20 !Fig.3-6 To Get Measurement Trace Using
30 !           IEEE 64-bit Floating point Format (For External Controller)
40 !
50 ASSIGN @Hp4395 TO 717
60 !
70 INPUT "ENTER CENTER FREQUENCY (Hz)",F_cent
80 INPUT "ENTER FREQUENCY SPAN (Hz)",F_span
90 OUTPUT @Hp4395;"CENT";F_cent
100 OUTPUT @Hp4395;"SPAN";F_span
110 !
120 OUTPUT @Hp4395;"CLES"
130 OUTPUT @Hp4395;"*SRE 4;ESNB 1"
140 ON INTR 7 GOTO Sweep_end !
150 ENABLE INTR 7;2 !
160 OUTPUT @Hp4395;"SING"
170 Measuring:GOTO Measuring
180 Sweep_end: !
190 DIM Dat(1:801,1:2),Swp(1:801) ! For spectrum measurement, change
200 OUTPUT @Hp4395;"POIN?" ! "Dat(1:801,1:2)" to "Dat(1:801)"
210 ENTER @Hp4395;Nop
220 REDIM Dat(1:Nop,1:2),Swp(1:Nop)
230 OUTPUT @Hp4395;"FORM3"
240 ASSIGN @Dt TO 717;FORMAT OFF
250 OUTPUT @Hp4395;"OUTPDTRC?"
260 ENTER @Dt USING "%,8A";A$
270 ENTER @Dt;Dat(*)
280 ENTER @Dt USING "%,1A";B$
290 OUTPUT @Hp4395;"OUTPSWPRM?"
300 ENTER @Dt USING "%,8A";A$
310 ENTER @Dt;Swp(*)
320 ENTER @Dt USING "%,1A";B$
330 ASSIGN @Dt TO *
340 !
350 FOR I=1 TO Nop
360 PRINT Swp(I);"Hz",Dat(I,1);"dB" ! For spectrum measurement, change
370 NEXT I ! "Dat(I,1)" to "Dat(I)"
380 END
```

Figure 3-6.

Sample Program : To Get Measurement Trace Using IEEE 64-bit Floating Point Format (For External Controller)

This program is similar to the ASCII transfer program. However, you must set the data transfer format OFF when using the binary data transfer format.

Set the Receive Array

```
190 DIM Dat(1:801,1:2),Swp(1:801)
200 OUTPUT @Hp4395;"POIN?"
210 ENTER @Hp4395;Nop
220 REDIM Dat(1:Nop,1:2),Swp(1:Nop)
```

Line 190 sets the array size to the analyzer's maximum number of measurement points (801).

In this example, it is assumed that the analyzer is in the network analyzer mode of operation, in which each point has complex data. If you use the analyzer in the spectrum analyzer mode, each measurement point has only real data, so you must set the data array `Dat` as follows:

```
190 DIM Dat(1:801),Swp(1:801)
220 REDIM Dat(1:Nop),Swp(1:Nop)
360 PRINT Swp(I);"Hz",Dat(I);"dB"
```

Lines 200 and 210 interrogate the analyzer to determine the number of measurement points. Line 220 resizes the receive array to match the data.

Set Data Transfer Format

```
200 OUTPUT @Hp4395;"FORM3"
210 ASSIGN @Dt TO 717;FORMAT OFF
```

To use FORM3 the computer must be instructed to stop formatting the incoming data with the `ENTER` statement. This is done by defining an I/O path with ASCII formatting `OFF`. The I/O path points to the analyzer. This path can be used to read or write data to the analyzer, as long as that data is in binary rather than ASCII format.

What are other binary data formats?

You can use the following data transfer formats, by changing the GPIB command `FORM3` in line 200.

- IEEE 32 bit floating point format **FORM2**
- MS-DOS® personal computer format **FORM5**

Read Data

```
250 OUTPUT @Hp4395;"OUTPDTRC?"
260 ENTER @Dt USING "%,8A";A$
270 ENTER @Dt;Dat(*)
280 ENTER @Dt USING "%,1A";B$
290 OUTPUT @Hp4395;"OUTPSWPRM?"
300 ENTER @Dt USING "%,8A";A$
310 ENTER @Dt;Swp(*)
320 ENTER @Dt USING "%,1A";B$
```

FORM3 has an eight-byte header to deal with. The first two bytes are the ASCII characters `#6`. This indicates that a fixed length block transfer follows and that the next 6 bytes form an integer specifying the number of bytes in the block to follow. The header must be read in so that data order is maintained (lines 260 and 300).

At the data end, the terminator `"LF^EOI"` is sent (lines 280 and 320).

3-12 Processing and Transferring Data

Data Formats in Binary Transferring

The analyzer can transmit data over GPIB in four different formats. The type of format affects what kind of data array is declared (real or integer), because the format determines what type of data is transferred.

■ Form 2

IEEE 32-bit floating point format. Figure 3-7 shows the data transfer format of Form 2. In this mode, each number takes 4 bytes.

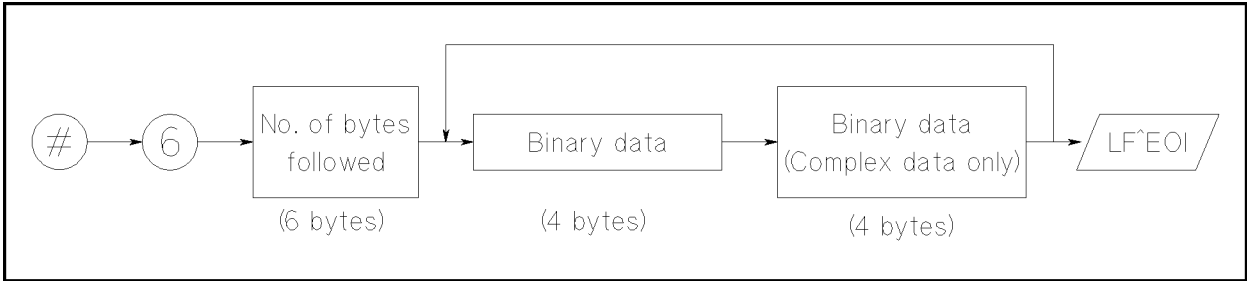

C4502004

Figure 3-7. Form 2 Data Transfer Format

■ Form 3

IEEE 64-bit floating point format. Figure 3-8 shows the data transfer format of Form 3. Data is stored internally in the 200/300 series computer with the IEEE 64-bit floating point format, eliminating the need for any reformatting by the computer. In this mode, each number takes 8 bytes.

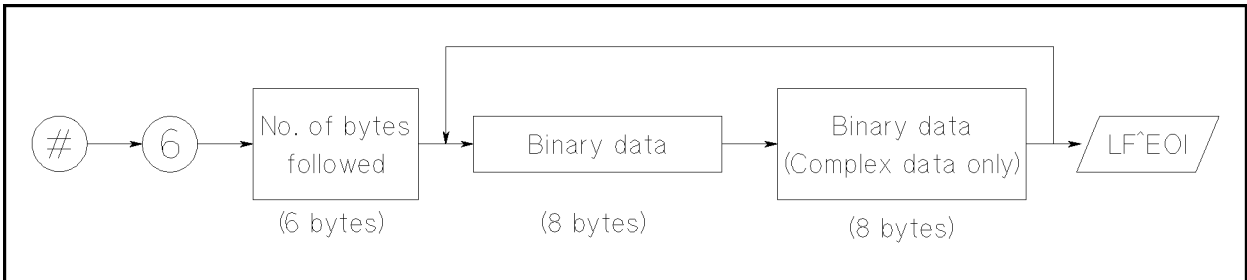

C4502003

Figure 3-8. Form 3 Data Transfer Format

■ Form 4

ASCII data transfer format. In this mode, each number is sent as a 24-character string, each character being a digit, sign, or decimal point.

■ Form 5

MS-DOS[®] personal computer format. This mode is a modification of IEEE 32-bit floating point format with the byte order reversed. Form 5 also has a four-byte header that must be read in so that data order is maintained. In this mode, an MS-DOS[®] PC can store data internally without reformatting it.

File Headers

When using the binary data transfer format, the transferred data must be accompanied by the file header that represents the data length. In this example, the data transfer format is FORM3 and the transferred data is configured as follows:

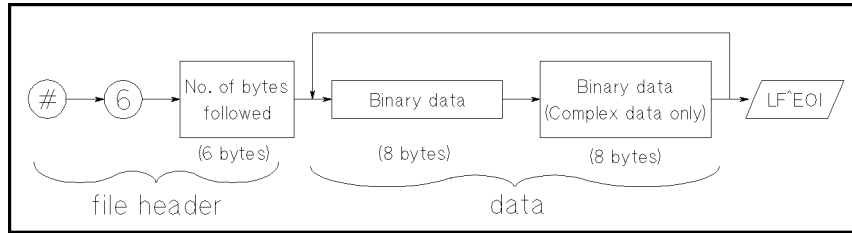

Figure 3-9. FORM3 Data Transfer Format

If you are not reading the header, you can create it using the number of data points. Change the program lines 440 to 460 as follows:

```
440  OUTPUT @Hp4395;"POIN?"
441  ENTER @Hp4395;Nop
442  V$=VAL$(Nop*2*8)
443  Numv=LEN(V$)
444  Head$="000000"
445  FOR I=1 TO Numv
446    Head$[7-I,7-I]=V$[Numv-I+1,Numv-I+1]
447  NEXT I
448  !
449  OUTPUT @Hp4395;"INPUCALC1 ";
450  OUTPUT @Dt USING "#,8A";"#6"&Head$
460  OUTPUT @Dt;Dat(*),END
```

Lines 440 to 442 calculate the number of bytes transferred (8 byte for real part, 8 byte for imaginary part), and represents it in the string format.

Line 443 counts the number of characters in the string that contains the number of bytes transferred.

Line 444 enters 0 as the initial value in all header arrays.

Lines 445 to 447 place the number of bytes transferred to the header array digit by digit from the sixth array to the first array of the header.

For example, if the number of points is 201, the value of Head\$ is 003216.

Saving a Data File

This section explains how to save data from the 4395A to a storage device. All examples contained herein assume that you intend to output measurement data from the 4395A upon completion of a measurement and then save the data on a floppy disk.

If you wish to use the following sample program with Instrument BASIC, specify in advance a memory disk or floppy disk drive as the target storage device.

```
10 DIM Dat(1:802,1:2)
20 ASSIGN @Hp4395 TO 717
40 OUTPUT @Hp4395;"POIN?"
50 ENTER @Hp4395;Nop
60 REDIM Dat(1:Nop,1:2)
70 OUTPUT @Hp4395;"FORM4"
80 OUTPUT @Hp4395;"OUTPDTRC?"
90 ENTER @Hp4395;Dat(*)
100 !
110 !
120   Fname$="data01"
130   PURGE Fname$
140   CREATE Fname$,1
150   ASSIGN @F TO Fname$;FORMAT ON
160   OUTPUT @F;Dat(*)
170   ASSIGN @F TO *
180   !
190 END
```

Figure 3-10. Saving Data on a Floppy Disk

Creating a File to Contain the Data

```
120   Fname$="data01"
130   PURGE Fname$
140   CREATE Fname$,1
```

The above code creates a file named `data01`. Notice that line 120 deletes any existing file named `data01`.

Opening the File and Transferring the Data

```
150   ASSIGN @F TO Fname$;FORMAT ON
160   OUTPUT @F;Dat(*)
170   ASSIGN @F TO *
```

The above code opens the file in the ASCII format, and transfers the trace data to the file. Line 170 closes the file; this statement is required if you are dealing with multiple files.

Data Levels

The analyzer has the following data arrays in internal memory:

- Raw data

These arrays store the results of all the preceding data processing operations. Note that the numbers here are still complex pairs.

When the Network analyzer mode and the full 2-port error correction are on, the raw data arrays contain all four S-parameter measurements required for accuracy enhancement.

- Error corrected data

The results of error correction are stored in the data arrays as complex number pairs.

- Formatted data

This is the array of data being displayed. It reflects all post-processing functions such as electrical delay, and the units of the array read out depends on the current display format.

- Calibration coefficients (Network and impedance analyzer only)

The results of a calibration are stored arrays of calibration coefficients that are used by the error correction routines. Each array corresponds to a specific error term in the error model. The calibration coefficients are read out with `OUTPCALC{1-12}?`.

- fixture compensation coefficients (Impedance analyzer only)

The results of a fixture compensation are stored arrays of fixture compensation coefficients that are used by the error correction routines. Each array corresponds to a specific error term in the error model. The fixture compensation coefficients are read out with `OUTPCOMC{1-3}?`.

Formatted data is generally the most useful, because it is the same information as that seen on the display. However, if post-processing is not necessary, as may be the case with smoothing, error corrected data is more desirable. Error corrected data also gives you the opportunity to load the data into the instrument and apply post-processing at a later time.

Calibration Types and Standard Classes, and Calibration Arrays

Table 3-1 lists which standard classes are required for each calibration type. This table shows that, for example, S_{11} 1 port calibration requires three calibrations; S11A(OPEN), S11B(SHORT), and S11C(LOAD).

Table 3-1. Calibration Types and Standard Classes

Class	Response	Response and Isolation	S_{11} 1-port	S_{22} 1-port	One-path 2-port	Full 2-port	ZA calibration
Response:	•						
Response and isolation:							
Response		•					
Isolation		•					
Reflection: ¹							
S11A (opens)			•		•	•	
S11B (shorts)			•		•	•	
S11C (loads)			•		•	•	
S22A (opens)				•		•	
S22B (shorts)				•		•	
S22C (loads)				•		•	
Transmission: ¹							
Forward match					•	•	
Forward thru					•	•	
Reverse match						•	
Reverse thru						•	
Isolation: ¹							
Forward					•	•	
Reverse						•	
Impedance analyzer cal							
IMPA (OPEN)							•
IMPB (SHORT)							•
IMPC (LOAD)							•

¹ These subheadings must be called when doing 2-port calibrations.

Table 3-2 specifies where the calibration coefficients are stored for different calibration types.

Table 3-2. Calibration Array

Array	Response ¹	Response and Isolation ¹	1-port ¹ ZA cal	2-port ^{1,2}
1	E_R or E_T	$E_X (E_D)^3$	E_D	E_{DF}
2		$E_T (E_R)$	E_S	E_{SF}
3			E_R	E_{RF}
4				E_{XF}
5				E_{LF}
6				E_{TF}
7				E_{DR}
8				E_{SR}
9				E_{RR}
10				E_{XR}
11				E_{LR}
12				E_{TR}

1 Meaning of first subscript: D=directivity; S=source match; X=crosstalk; L=load match; T=transmission tracking.
 Meaning of second subscript: F=forward; R=reverse.

2 One path, 2-port cal duplicates arrays 1 to 6 in arrays 7 to 12.

3 Response and isolation corrects for crosstalk and transmission tracking in transmission measurements, and for directivity and reflection tracking in reflection measurements.

The table shows that, for example, for 1 port calibration (or calibration for impedance analyzer mode), E_D (directive error-correction coefficients) is stored in the first element of an array, E_S (source match error-correction coefficients) in the second, and E_R (reverse error-correction coefficients) in the third.

Synchronizing the 4395A with a Controller

You can use a program running on a controller to remotely instruct an GPIB compatible device to calibrate itself, output measurement data, perform calculations or other tasks. Implementing such a remote control system, however, requires you to keep the 4395A synchronized with the program execution.

For example, when obtaining measurement data, the controller must wait until the 4395A completes the current measurement process. For calibration, the controller must wait until the 4395A finishes processing the data.

You can synchronize the 4395A with the controller in several ways:

- Use the `*OPC?` command to suspend the controller until the preceding command is completed.
- Use the `WAIT` command of BASIC.
- Use an `EXECUTE SING` statement of Instrument BASIC to suspend the program until the completion of the sweep process.
- Use an `SRQ` to suspend the external controller until the completion of the sweep process.

Also, you can use a `*WAI` command to suspend the execution of an GPIB command although this technique does not provide synchronization with a controller.

Using the *OPC Command

```
10 !
20 !Fig.4-1 To Wait for the Preceding Operation Complete
30 !
40 ASSIGN @Hp4395 TO 717      ! When iBASIC is used, change "717" to "800"
50 !
60 ! OUTPUT statement to send GPIB command
70 !
80 OUTPUT @Hp4395;"*OPC?"
90 ENTER @Hp4395;A
100 !
110 ! Next operation
120 !
130 END
```

Figure 4-1. Sample program: Wait until the preceding command is completed.

Suspending a Program Running on a Controller (*OPC)

```
80 OUTPUT @Hp4395;"*OPC?"
90 ENTER @Hp4395;A
```

The above code causes the controller to suspend the program execution until all preceding commands are successfully processed and *OPC? returns 1.

In Figure 2-2 (Chapter 1), for example, the *OPC? command is used as follows:

```
⋮
240 OUTPUT @Hp4395;"RESPDONE" ! Compute calibration coefficients
250 OUTPUT @Hp4395;"*OPC?"    ! Wait until completed
260 ENTER @Hp4395;Dum
270 DISP "Response cal completed."
⋮
```

Using the WAIT Command of BASIC

Using the WAIT command of BASIC, you can have the controller wait for a particular period of time. This is a very simple solution, but requires you to accurately measure the time required for the 4395A to actually process a certain command(s).

```
10 OUTPUT 717;"SA"
20 WAIT 5
30 OUTPUT 717;"NA"
40 WAIT 5
50 END
```

Since this technique causes the controller to wait without communicating with the 4395A, an improper wait time setting can result in an unpredictable error. However, using the WAIT command can effectively speed up the execution of your program as long as the setting is accurate.

Using the EXECUTE Statement to Synchronize with the Completion of Sweep

```
10 !
20 !Fig.4-2 To Wait for the Preceding Operation Complete
30 !
40 ASSIGN @Hp4395 TO 800 ! Only iBASIC is available
50 !
60 ! OUTPUT statement to send GPIB command
70 !
80 EXECUTE "SING"
90 OUTPUT @Hp4395;"MKR ON"
100 OUTPUT @Hp4395;"SEAM MAX"
110 ! Next operation
120 !
130 END
```

Figure 4-2. Sample program: Wait until the preceding command is completed.

Here is a tip: You can just issue a single EXECUTE "SING" statement to synchronize with the completion of sweep. This is useful, for example, when you want to use the marker after a single cycle of measurement.

```
80 EXECUTE "SING"
```

This causes the controller to wait until one cycle of sweep is completed.

```
90 OUTPUT @Hp4395;"MKR ON"
100 OUTPUT @Hp4395;"SEAM MAX"
```

Because the measurement is already completed, you can effectively use the marker.

Note that the EXECUTE command is supported for Instrument BASIC only.

Using SRQ

You can also use an SRQ to implement synchronization with the completion of sweep. This technique is recommended when you are using an external controller. For how to synchronize an SRQ with the completion of a sweep process that uses an SRQ, refer to "To Wait for Sweep End" in Chapter 5.

Using the *WAI Command

Note



If the active controller is an external controller, using the *WAI command cannot perfectly synchronize the controller with the 4395A.

The *WAI command prevents the 4395A from processing any newly received commands until it finishes processing all preceding commands. If the 4395A receives a new GPIB command during the wait, it stores the command in a buffer.

Example)

```
10 OUTPUT 717;"SING"  
20 OUTPUT 717;"*WAI"  
30 OUTPUT 717;"AUTO"  
40 PRINT "Program end"  
50 END
```

The above program inhibits the 4395A from processing the AUTO command until the completion of the SING command. However, the controller executes line 40 of the program, whether or not the SING command has been successfully processed. On the other hand, the 4395A does not execute the AUTO command until the completion of the SING command, regardless of the program execution on the controller.

Status Reporting System and Processing Generated Interruptions

The analyzer has a status reporting system to report the condition of the analyzer. This chapter gives you an overview of the status reporting system.

This chapter provides the following information:

- General status register model
- Status bit definitions of the Status Byte
- Status bit definitions of the Standard Event Status Register
- Status bit Definitions of the Operation Status Register
- OSPT, OSNT
- Using the Service Request (SRQ)
- Reporting command error occurrence (with sample program)
- Waiting for sweep end (with sample program)

What is an SRQ?

An SRQ (Service Request) is an interrupt generated by the analyzer. The analyzer can be setup to send an SRQ when it needs the attention of the controller. The controller can ignore the SRQ or it can be setup to interrupt the program using the ON INTR commands. The Status Byte can be used to define the specific event that generates an SRQ (for example, the end of sweep complete).

General Status Register Model

The analyzer has a status reporting system to report the condition of the analyzer.

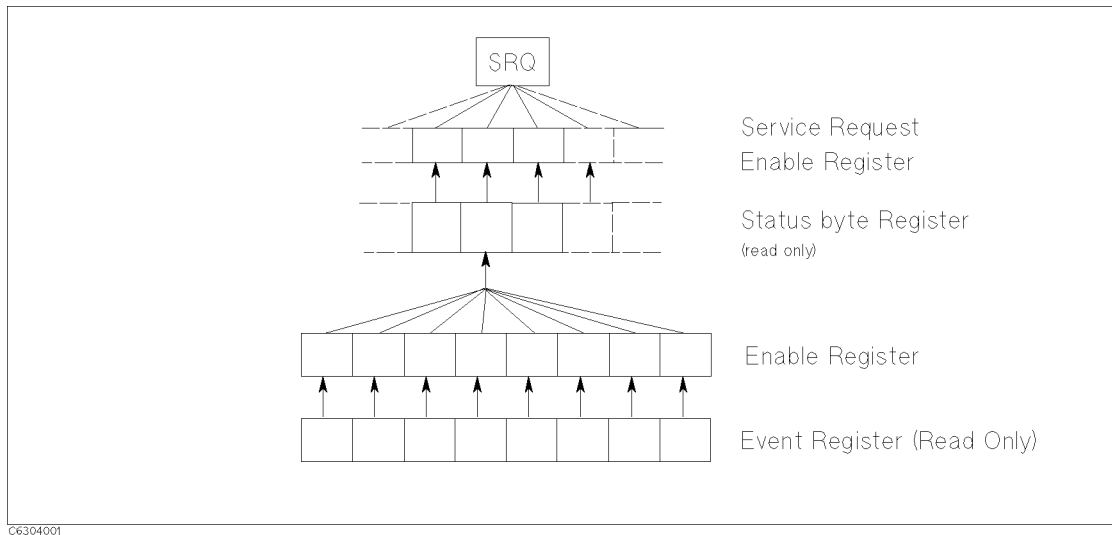

Figure 5-1. General Status Register Model

The status reporting system has a hierarchical structure as shown in Figure 5-1. When the analyzer condition satisfies the particular condition, the corresponding bit of the event register is set “1”. Therefore, you can check the analyzer condition by reading the event register.

When the event register bit is set to “1”, and corresponding enable register bit is also “1”, the summary bit of the status byte register is set to “1”. You can read the status byte register by using the serial poll.

If the corresponding bit of the service request enable register is “1”, the service request (SRQ) is generated with the positive transition of the status byte register bit. By generating the SRQ, you can notify the controller that the analyzer is requesting service.

Event Register

Reflects the correspondent analyzer condition as a bit status. These bits monitor the changing analyzer state continuously and change the bit status as required.

You cannot change bit status by GPIB command.

The analyzer has the following event registers:

- **Standard Event Status Register (ESB)** Contains the summary of general processing which includes completion of sweep. See Table 5-2 for details.
- **Event Status Register (ESR)** Contains the information on occurrence of an operation failure such as a command error. See Table 5-3 for details.
- **Operation Status Event Register (OSR)** Contains only the information that a program is running and/or data is being transferred to the printer. See Table 5-4 for details.

5-2 Status Reporting System and Processing Generated Interruptions

Enable Register

The enable register selects which event register bits can set the bit in the summary bit of the status byte register that is connected to SRQ generation. The register bits work like mask bits. When you want to set a bit in the status byte register by a specific register condition, set the corresponding enable register to 1. This sets a 1 bit in the status byte register with a corresponding event register bit.

Status Byte Register

If enabled event register is set to 1, the corresponding bit of the status byte register is set to 1. This register also indicates the output queue and SRQ status.

The value of the status byte register can be read by using the **SPOLL** statement or the ***STB?** query from the controller. Reading the status byte register by either command does not affect the contents of the status byte register. Table 5-1 lists the contents of the status byte register.

A serial poll initiated by using the **SPOLL** command reads bit 6 of the status byte register as the RQS bit. The ***STB?** command reads bit 6 as the MSS bit.

SRQ (Service Request) can be generated by the status byte register by setting the service request enable register. For more information about SRQ, see Figure 5-6 in this chapter.

Transition Filter and Condition Register

The transition filter allows you to select which transitions of the analyzer condition will set a bit in the event register.

When the status register has a transition filter, there is a lower register called a condition register under the event register. The transition filter is between the event register and the condition register. The transition filter enables you to select a positive and/or negative transition of the condition register bit to set a bit in the corresponding event register. For example, if you set the negative transition filter, a 1 is set in the event register by changing from 1 to 0 in the event register.

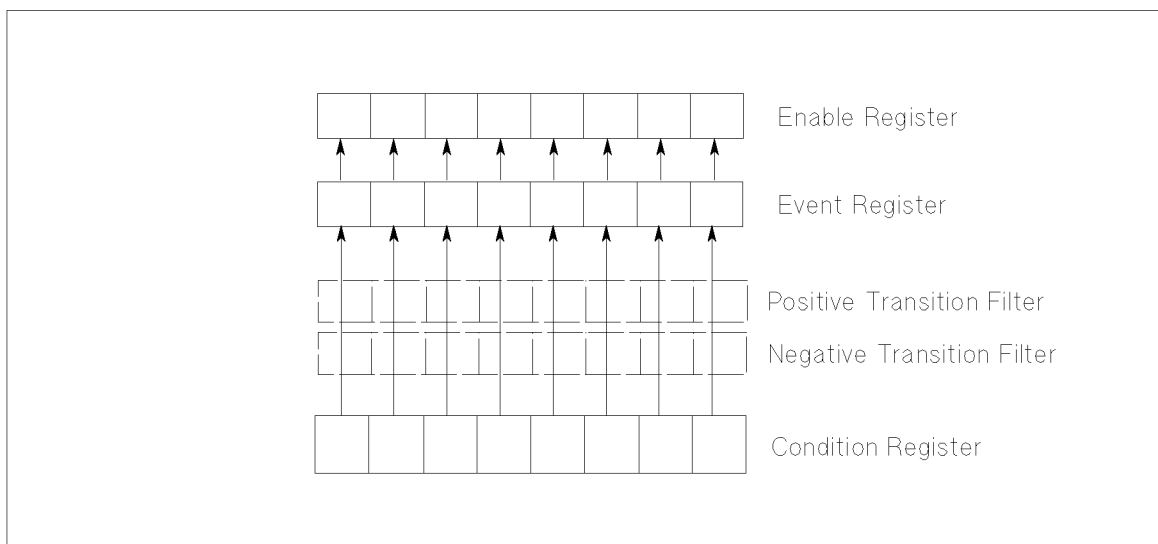

C6304002

Figure 5-2. Transition Filter and Condition Register

For the 4395A, only the “Program Running” bit of the operation status register has a transition filter. By using the transition filter, you can generate an SRQ either at the start or the end of the program execution.

Status Register Structure

Figure 5-3 shows the status reporting structure of the 4395A.

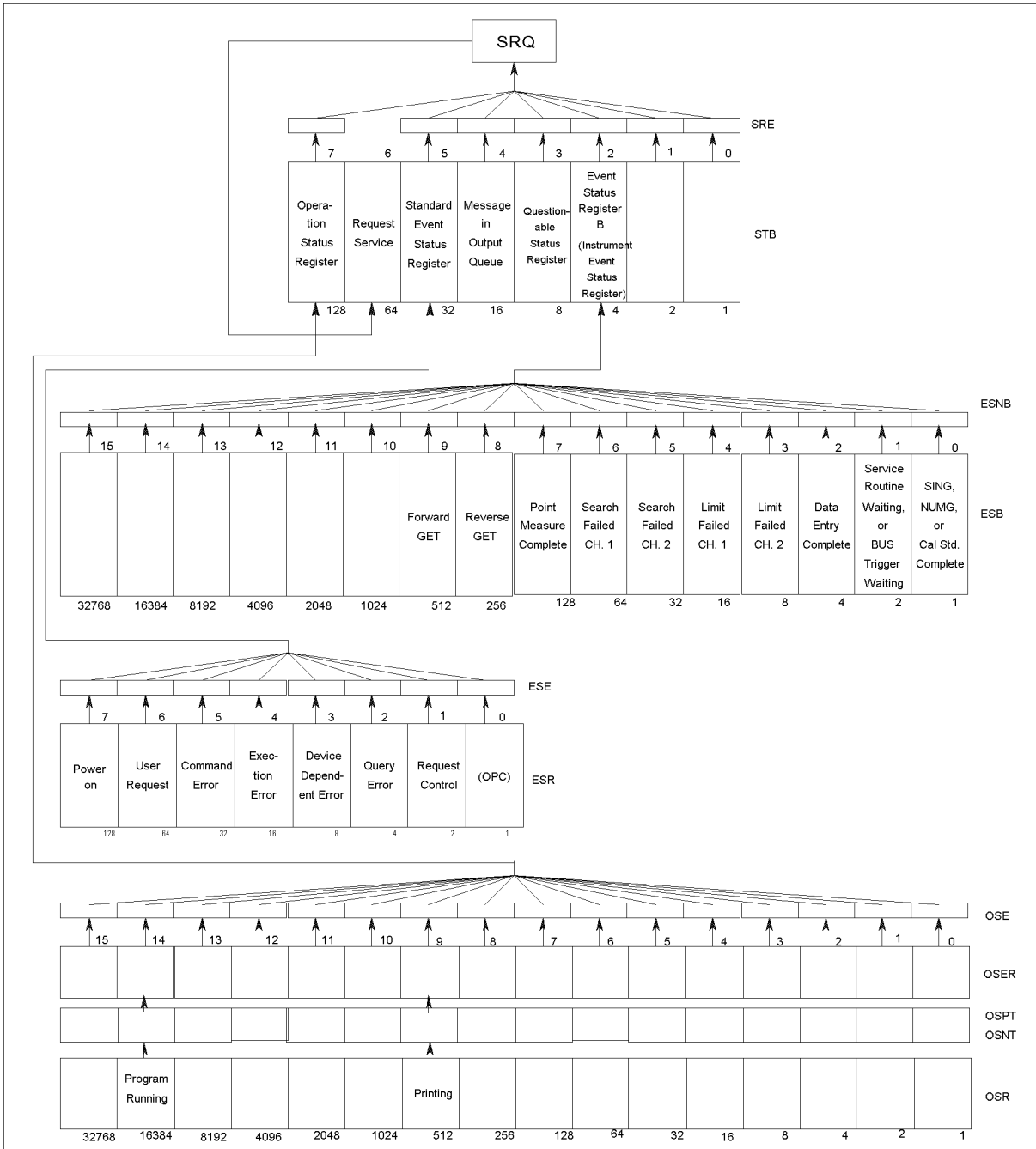

Figure 5-3. Status Reporting Structure

Status Bit Definitions of the Status Byte (STB)

The status bytes consist of 8-bit registers, with each bit representing a specific analyzer condition. The value of the Status Byte can be read by using SPOLL(717) statement from an external controller. This command reads a value directly from the analyzer without being set to remote. So, you can operate front panel keys while a controller is reading the Status Byte. Contents of the Status Byte can also be read by using the *STB? command. Reading the Status Byte does not affect the contents of the Status Byte. Table 5-1 shows contents of Status Byte.

Table 5-1. Status Bit Definitions of the Status Byte (STB)

Bit	Name	Description
2	Event Status Register B Summary Bit	One of the enabled bits in Event Status Register B (Instrument Event Status Register) has been set.
3	Questionable Status Register Summary Bit	The analyzer has no operation to report the event to the Questionable Status Register group. This register is available to keep the consistency with other SCPI compatible instruments.
4	Message in Output Queue	A command has prepared information to be output, but it has not been read yet.
5	Standard Event Status Register Summary Bit	One of the enabled bits in the Standard Event Status Register has been set.
6	Request Service	One of the enabled Status Byte bits is causing an SRQ.
7	Operation Status Register Summary Bit	One of the enabled bits in the Operation Status Register has been set.

For example, to read the contents of Message in the output queue,

```

10 Stat=SPOLL(717)
20 Stb4=BIT(Stat,4)
30 PRINT Stb4
40 END

```

Figure 5-4. Example of Reading Status Byte (1)

or,

```

10 ASSIGN Hp4395 TO 717
20 OUTPUT Hp4395;"*STB?"
30 ENTER Hp4395;Stat
40 Stb4=BIT(Stat,4)
50 PRINT Stb4
60 END

```

Figure 5-5. Example of Reading Status Byte (2)

5-6 Status Reporting System and Processing Generated Interruptions

Status Bit Definitions of ESB, ESR, and OSR

The Standard Event Status Register (ESR), Event Status Register B (ESB; Instrument Event Status Register), and Operation Status Register (OSR) are subordinate to the Status Byte. Each register can set a bit with a condition that is watched by status bit. A status bit is cleared when it is read by query or the CLES or *CLS command is executed.

Table 5-2. Status Bit Definitions of the Standard Event Status Register (ESR)

Bit	Name	Description
0	Operation Complete	A command for which OPC has been enabled, and completed an operation.
1	Request Control	The analyzer has been commanded to perform an operation that requires control of a peripheral, and needs control of GPIB.
2	Query Error	<ol style="list-style-type: none"> 1. The analyzer has been addressed to talk, but there is nothing in the output queue to transmit. 2. Data in the Output Queue has been lost.
3	Device Dependent Error	An error, other than a command error, a query error, and an execution error has occurred.
4	Execution Error	<ol style="list-style-type: none"> 1. A program data element following a header exceeded its input range, or is inconsistent with the analyzer's capabilities. 2. A valid program message could not be properly executed due to some analyzer condition.
5	Command Error	<ol style="list-style-type: none"> 1. An IEEE 488.2 syntax error has occurred. Possible violations include, a data element violated the analyzer listening formats or a data element type is unacceptable to the analyzer. 2. A semantic error that indicates an unrecognized header was received has occurred. Unrecognized headers include incorrect device-specific headers and incorrect or unimplemented IEEE 488.2 common commands. 3. A Group Execute Trigger (GET) was entered into the Input Buffer of a program message.
6	User Request	The operator pressed a front panel key or an optional keyboard key or turned the rotary knob.
7	Power ON	This bit is set when a power-on sequence occurs.

Table 5-3. Status Bit Definitions of the Event Status Register B (ESB)

Bit	Name	Description
0	SING, NUMG, or Cal Std. Complete	A single, group sweep, calibration, or compensation has been completed since the last read of the register. Operates in conjunction with SING or NUMG.
1	Service Routine Waiting or Bus Trigger Waiting	1. An internal service routine has completed an operation, or is waiting for an operator response. 2. The analyzer has set the manual trigger to the point mode and is waiting for a manual trigger.
2	Data Entry Complete	A terminator key has been pressed.
3	Limit Failed, Ch 2	Limit test failed on channel 2.
4	Limit Failed, Ch 1	Limit test failed on channel 1.
5	Search Failed, Ch 2	A marker search was executed on channel 2, but the target value was not found.
6	Search Failed, Ch 1	A marker search was executed on channel 1, but the target value was not found.
7	Point Measurement Complete ¹	One measurement point of a sweep has been completed.
8	Reverse GET	A one-path 2-port calibration is active, and the analyzer has stopped, waiting for the operator to connect the device for a reverse measurement.
9	Forward GET	A one-path 2-port calibration is active, and the analyzer has stopped, waiting for the operator to connect the device for a forward measurement.

¹ This bit is set only when the related bits of both SRE and ESNB are enabled.

In the case of the manual trigger on point mode, the analyzer accepts the next trigger while the current measurement is in progress (up to the number of points). Use bit 1 and bit 7 correctly to synchronize the measurement and external triggering. For example, 1) wait until bit 1 is set, 2) trigger, and 3) wait until bit 7 is set.

Table 5-4. Status Bit Definitions of the Operation Status Register (OSR)

Bit	Name	Description
9	Printing	Data is being transferred to the printer.
14	Program running	An HP Instrument BASIC program is running.

Each status register has a register that enables generating a Service Request (SRQ) with a condition of a status bit. For instance, to generate an SRQ when the analyzer completes the specified number of sweeps, enable ESNB bit 1. Bit 1 of ESNB is the mask register for ESB 0 (“SING, NUMG, or Cal Std. Complete”) which shows sweep completion and SRE bit 2. This enables a path from ESB bit 0 to generate an SRQ. Figure 5-6 shows a program listing that can be used to generate an SRQ.

5-8 Status Reporting System and Processing Generated Interruptions

```

10 ASSIGN Hp4395 TO 717
20 !
30 OUTPUT Hp4395;"CLES" ! Clears status registers
40 OUTPUT Hp4395;"ESMB 1" ! Enables mask register of "SING. NUMG. or
50 ! ! Cal Std. Complete" of ESB
60 OUTPUT Hp4395;"*SRE 4" ! Enables mask register of "Event Status
70 ! ! Register B" of STB
80 !
90 ON INTR 7 GOTO End ! Declare SRQ interrupt
100 ENABLE INTR 7;2
110 OUTPUT Hp4395;"SING" ! Execute single sweep
120 GOTO 120 ! Endless loop
130 !
140 End: ! Exit from loop when sweep is completed
150 END

```

Figure 5-6. Example of Generating a Service Request (SRQ)

OSPT, OSNT

OSPT (Operation Status Positive Transition Filter)

Sets the positive transition filter. Setting a bit in OSPT will cause a 0 to 1 transition in the corresponding bit of the associated Operation Status Register (OSR) to cause a 1 to be written in the associated bit of corresponding Operation Status Event Register (OSER).

Bit 14 of the analyzer's OSR is used to show program status. When bit 14 of OSPT is set to 1, starting a program causes a 1 to be written in bit 14 of OSER. (This sets bit 7 of STB to 1.)

OSNT (Operation Status Negative Transition Filter)

Sets the negative transition filter. Setting a bit in the negative transition filter will cause a 1 to 0 transition in the corresponding bit of the associated Operation Status Register to cause a 1 to be written in the associated bit of corresponding Operation Status Event Register.

Bit 14 of the analyzer's OSR is used to show program status. When bit 14 of OSNT is set to 1, stopping a program causes a 1 to be written in bit 14 of OSER. (This sets bit 7 of STB to 1.)

How to Use the Status Registers in a Program

You can use the status registers to determine the specific analyzer status in the program. To determine the contents of the status register, the following methods are used:

- Read an event register directly.
- Use the Service Request (SRQ).

Reading an Event Register Directly

You can read the contents of the event register directly to determine the specific analyzer condition. Use this method if you do not need to know the timing of the event register changes. The following procedure reads the register directly:

1. Query the event register or the condition register contents.
2. Retrieve a return value.

The list shown below is an HP-BASIC sample program using the BIT function.

<pre>OUTPUT @Hp4395"ESB?" ENTER @Hp4395Esb IF BIT(Esb,4) THEN DISP "LIMIT TEST FAILED AT Ch 1." END IF</pre>	<p><i>Queries instrument event status register contents.</i></p> <p><i>Retrieve return value.</i></p> <p><i>If bit 4 of the instrument event status register is set to 1, the limit test failed on channel 1.</i></p>
--	---

Module 4-. Reading an Event Register

- Related GPIB Commands. The following query commands can be used to read the contents of an event register directly.

- *STB? Returns Status Byte Register contents.
- *ESR? Returns Event Status Register contents.
- ESB? Returns Instrument Event Status Register contents.
- OSR? Returns Operation Status Register contents.

To Report Command Error Occurrence

This section provides an example which describes how to report command error occurrence using SRQ.

```
10  !
20  !Fig.5-7 To Report Command Error Occurrence
30  !
40  ASSIGN @Hp4395 TO 717 ! When iBASIC is used, change "717" to "800"
50  !
60  DIM Err$(30)
70  OUTPUT @Hp4395;"CLES"
80  OUTPUT @Hp4395;"*SRE 32 ;*ESE 32"
90  ON INTR 7 GOSUB Err_report ! \ When iBASIC is used,
100 ENABLE INTR 7;2 ! / change "7" to "8"
110  !
120  ! OUTPUT statement to send GPIB command
130  !
140  !
150  !
160  GOTO Prog_end
170 Err_report: !
180  OUTPUT @Hp4395;"OUTPERRO?"
190  ENTER @Hp4395;Err,Err$
200  PRINT "COMMAND ERROR DETECTED"
210  PRINT Err,Err$
220  !
230  A=SPOLL(@Hp4395)
240  OUTPUT @Hp4395;"*ESR?"
250  ENTER @Hp4395;Estat
260  ENABLE INTR 7 ! When iBASIC is used, change "7" to "8"
270  RETURN
280 Prog_end: !
290  END
```

Figure 5-7. Sample Program : To Report Command Error Occurrence

Enable Error Bit

```
70  OUTPUT @Hp4395;"CLES"
80  OUTPUT @Hp4395;"*SRE 32 ;*ESE 32"
```

Line 70 clears all bits of the Status Registers and Enable Registers.

In line 80, the command *SRE 32 sets the Service Request Enable Register to 00100000 (this enables bit 5 of the Status Byte Register). The command *ESE 32 sets the Standard Event Status Enable Register to 00100000 (this enables bit 5 of the Standard Event Status Register (see Figure 5-8)).

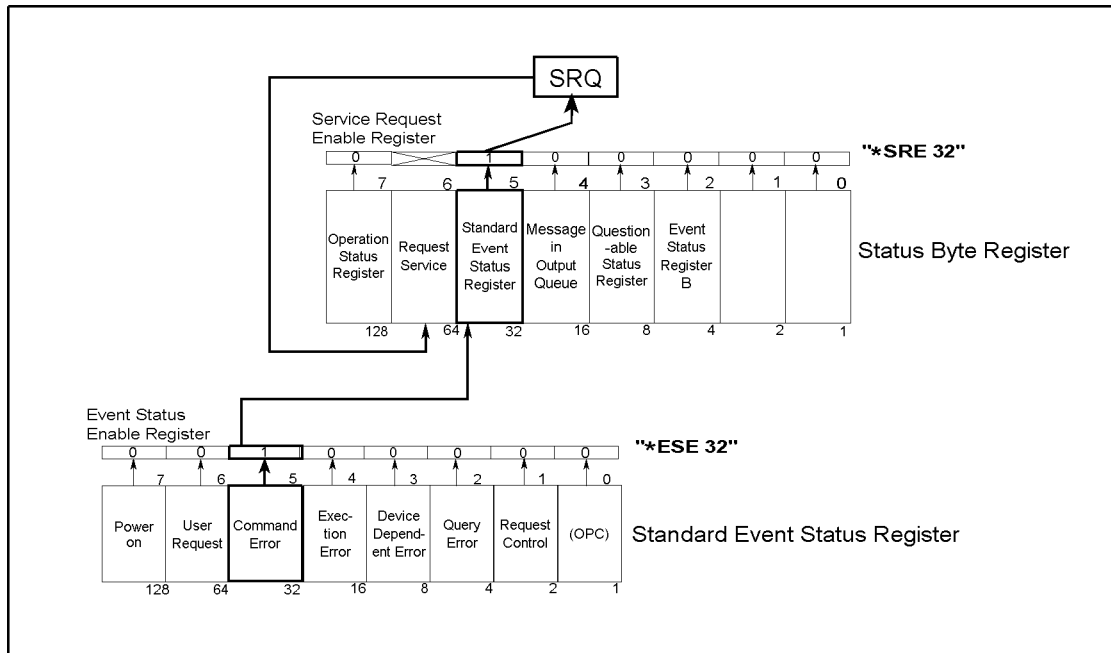

CC100501

Figure 5-8. Command-Error Bit Enabling

Report Command Error

```

90  ON INTR 7 GOSUB Err_report  ! \ When iBASIC is used,
100 ENABLE INTR 7;2           ! / change "7" to "8"
110  !
120  !  OUTPUT statement to send GPIB command
130  !
140  !
150  !
160  GOTO Prog_end
170 Err_report:  !

```

If an GPIB command (executed between lines 100 and 160) causes a GPIB command error, the analyzer generates an SRQ and the controller branches to `Err_report`. For example, the OUTPUT statement:

```
120 OUTPUT @Hp4395;"CENT " Setting center frequency, but no parameter
```

Output Error

```

180  OUTPUT @Hp4395;"OUTPERR0?"
190  ENTER @Hp4395;Err,Err$
200  PRINT "COMMAND ERROR DETECTED"
210  PRINT Err,Err$

```

These commands retrieve the error number and description.

In the error shown in the line 120 example, the controller displays the following:

5-12 Status Reporting System and Processing Generated Interruptions

```
COMMAND ERROR DETECTED
-109  "Missing parameter"
```

Many different kinds are defined for GPIB errors. Refer to the error code table when an error occurs.

Return to Execute GPIB command

```
230     A=SPOLL(@Hp4395)
240     OUTPUT @Hp4395;"*ESR?"
250     ENTER @Hp4395;Estat
260     ENABLE INTR 7      ! When iBASIC is used, change "7" to "8"
270     RETURN
```

Lines 230 to 270 clear SRQ before returning to the main routine.

Line 230 reads the analyzer's status byte. The `A=SPOLL(@Hp4395)` statement reads the Status Byte Register of the address `@Hp4395`(analyzer), and enters the value into `A`. The command error causes the SRQ and with bit 5 and bit 6 of the Status Byte Register set, the value of `A` is 96. Reading the Status Byte Register by using the `SPOLL` command clears SRQ (status byte bit 6).

In line 240 and line 250, the command `*ESR?` reads the contents of the Standard Event Status Register. With Bit 5 of Standard Event Status Register set, the value of `Estat` is 32. Reading the Standard Event Status Register by using the `*ESR?` command clears the register.

A branch to `Err_report` disables the interrupt. Therefore, the return from `Err_report` must reenables the interrupt.

To Wait for Sweep End

```

10 !
20 !Fig.5-9 To Wait for Sweep End
30 !
40 ASSIGN @Hp4395 TO 717 ! When iBASIC is used, change "717" to "800"
50 OUTPUT @Hp4395;"TRGS INT"
60 OUTPUT @Hp4395;"CLES"
70 OUTPUT @Hp4395;"*SRE 4;ESNB 1"
80 ON INTR 7 GOTO Sweep_end ! \ When iBASIC is used, change "7" to "8"
90 ENABLE INTR 7;2 ! /
100 OUTPUT @Hp4395;"SING"
110 Measuring:GOTO Measuring
120 Sweep_end: !
130 DISP "MEASUREMENT COMPLETE"
140 END

```

Figure 5-9. Sample Program : To Wait for Sweep End

Enable Sweep-End Bit

```

60 OUTPUT @Hp4395;"CLES"
70 OUTPUT @Hp4395;"*SRE 4;ESNB 1"

```

Line 60 clears all bits of the Status Registers and the Enable Registers.

In line 70, the command *SRE 4 sets the Service Request Enable Register to 00000100 (this enables bit 2 of the Status Byte Register). The command ESNB 1 sets the Event Status Enable Register B to 0000000000000001 (this enables bit 0 of the Event Status Register B. See Figure 5-10).

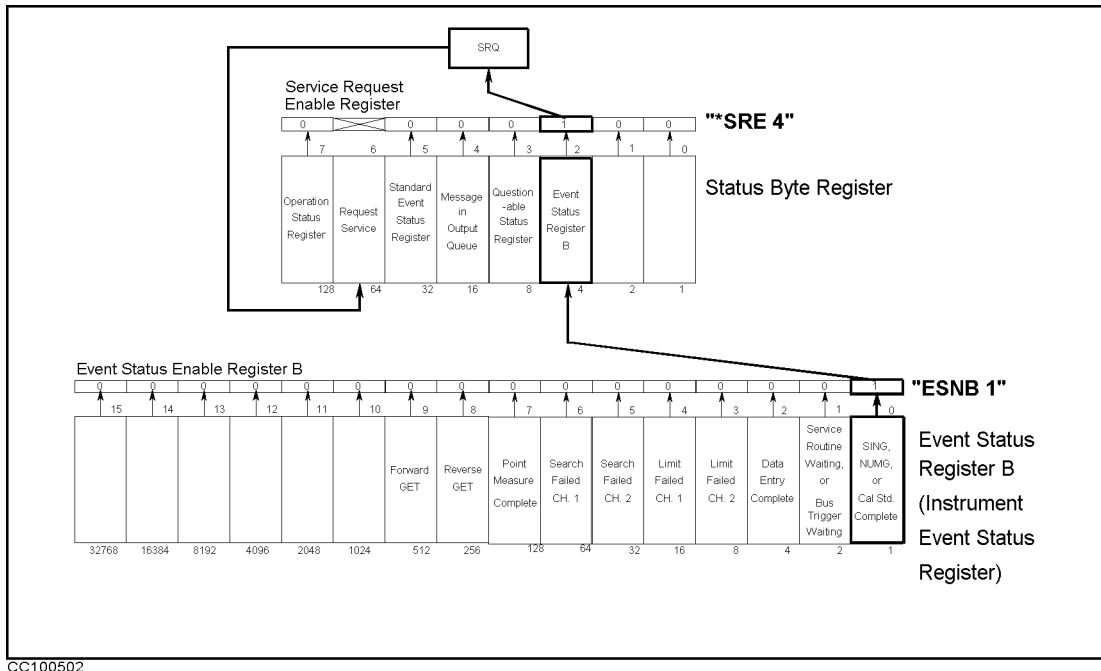

Figure 5-10. Sweep-End Bit Enabling

Enable Registers select which events in the analyzer can cause a service request (SRQ). By setting bit 0 of the Event Status Enable Register B to 1, the occurrence of the corresponding

5-14 Status Reporting System and Processing Generated Interruptions

event (sweep-end) sets bit 0 of the Event Status Register B. When this bit is set (and is enabled), it is used to set a summary bit in the Status Byte Register (bit 2). Also, because bit 2 of Service Request Enable Register is set, setting the corresponding bit (Event Status Register B summary bit) generates an SRQ. The SRQ sets bit 6 of the Status Byte Register.

Enable SRQ Interrupt

```
80  ON INTR 7 GOTO Sweep_end  ! \ When iBASIC is used, change "7" to "8"
90  ENABLE INTR 7;2          ! /
  :
120 Sweep_end:  !
```

Line 80 defines a branch. When the SRQ interrupt is generated from the GPIB interface (whose select code is 7), the controller goes to `Sweep_end` (Line 120).

Line 90 enables an interrupt from interface 7 (GPIB) when bit 1 (SRQ bit) of the interrupt register (of the controller) is set by a value of 2.

Wait Until Measurement Is Done

```
100  OUTPUT @Hp4395;"SING"
110 Measuring:  GOTO Measuring
```

The controller loops back in line 110 until an SRQ interrupt occurs.

Generate SRQ

On a single sweep end, bit 0 of the ESB is set (which sets bit 2 of the Status Byte Register) and an SRQ is generated.

```
120 Measuring:  GOTO Measuring  Loop until SRQ interrupt
130 Sweep_end:  !              At SRQ interrupt, jump to here
```

Once an SRQ is generated, the SRQ interrupt is disabled.

Using the Trigger System in 4395A

This chapter describes how to control the trigger system of the analyzer.

To trigger a measurement from a controller, the following steps are commonly used:

1. Set the trigger source to:
Bus, or Internal (free run)
(In External, Video, Manual or Gate trigger, you cannot trigger from the controller, so these sources are not mentioned in this guide.)
2. Set the number of measurements and the analyzer is initiated. You can set the number of measurements as:
(Hold)—Single—Number of Group—Continuous
3. Generate the trigger event and the analyzer starts a measurement.

The analyzer trigger system has three states: Idle, Waiting for Trigger, and Measurement.

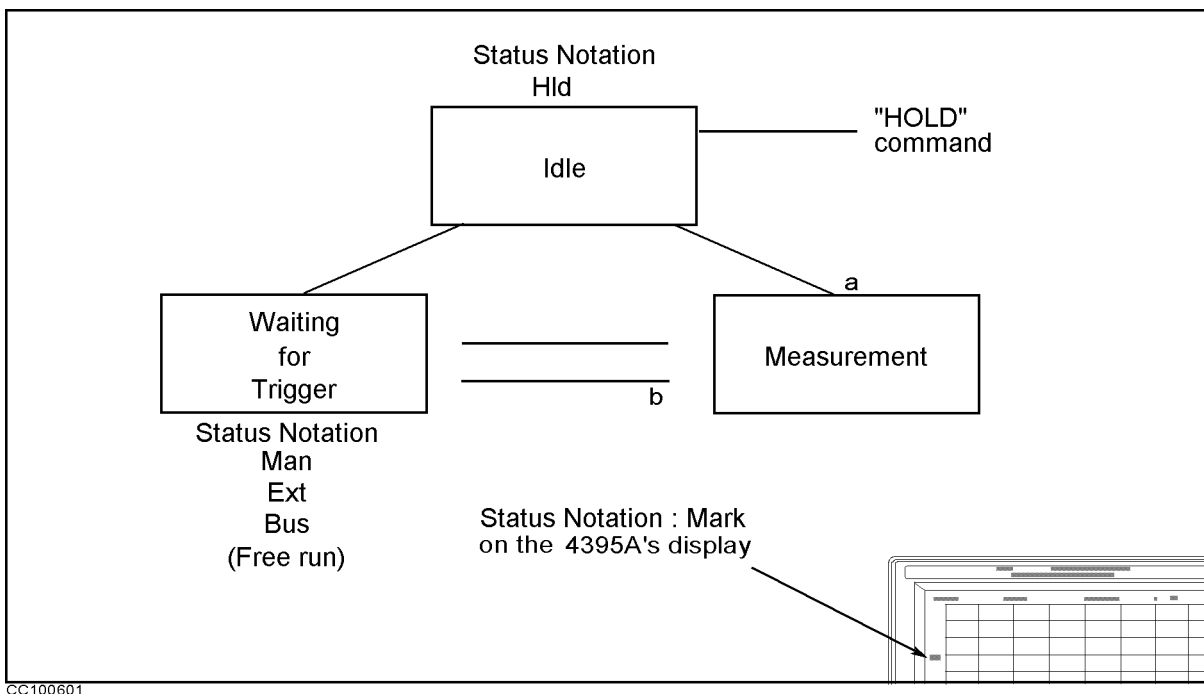

Figure 6-1. Trigger System

In Figure 6-1,

1. After a HOLD GPIB command execution, the analyzer returns to the “Idle” state.
2. By setting the number of measurements, the analyzer changes from the “Idle” state to the “Waiting for Trigger” state.
3. At the “Waiting for Trigger” state, a trigger input (corresponding to the trigger source) starts a measurement.

Bus GPIB command *TRG or BASIC command TRIGGER triggers measurements.

Internal (free run) There is no need for a trigger input. The analyzer starts the measurements immediately.

4. After the measurement is complete, the next state depends on the number of measurements.

Single goes to the “Idle” state(4-a).

Number of Groups Goes to the “Waiting for Trigger” state until the number of groups not measured yet equals zero(4-b).

After all measurements are completed, goes to “Idle” state(4-a).

Continuous goes to the “Waiting for Trigger” state(4-b).

To Measure Continuously

```
10 !
20 !Fig.6-2 To Trigger Measurement Continuously
30 !
40 ASSIGH @Hp4395 TO 717 ! When iBASIC is used, change "717" to "800"
50 OUTPUT @Hp4395;"TRGS INT"
60 OUTPUT @Hp4395;"CONT"
70 END
```

Figure 6-2. Sample Program : To Trigger Measurements Continuously

Set Trigger Source

```
50 OUTPUT @Hp4395;"TRGS INT"
```

Set the trigger source to internal.

Start Continuous Measurement Sweep

```
60 OUTPUT @Hp4395;"CONT"
```

The analyzer changes to the “Waiting for Trigger” state. In this program, the internal trigger source is selected and the analyzer immediately starts continuous measurements.

What can you do to
abort a measurement?

Send the command:

```
OUTPUT @Hp4395;"HOLD"
```

Note



The 4395A will fail in proper measurement data transfer when it is triggered using the internal trigger source. If you want to transfer measurement data to the controller, you must use either the **SING** or the **NUMG parameter** command to synchronize the controller and the analyzer. To use these commands, see “Using the EXECUTE Statement to Synchronize with the Completion of Sweep” in Chapter 4 and “To Wait for Sweep End” in Chapter 5.

To Trigger a Measurement From the Controller

Two methods of triggering a measurement from the controller are shown in Figure 6-3 and Figure 6-4.

```
10 !
20 !Fig.6-3 To Trigger Measurement From Controller(1)
30 !
40 ASSIGN @Hp4395 TO 717 ! When iBASIC is used, change "717" to "800"
50 OUTPUT @Hp4395;"TRGS INT"
60 OUTPUT @Hp4395;"SING"
70 END
10 !
```

Figure 6-3. Sample Program : To Trigger a Measurement from Controller (1)

Set Trigger Source

```
50 OUTPUT @Hp4395;"TRGS INT"
```

Set the trigger source to internal.

Trigger a Measurement

```
60 OUTPUT @Hp4395;"SING"
```

The analyzer changes to the “Waiting for Trigger” state. In this program, the internal source is selected and the analyzer immediately starts a measurement. After the measurement, the analyzer goes to the “Idle” state.

**How can you perform
averaging?**

When you set the averaging on, you must also set the number of measurements to the same value as the averaging factor. For example, if the averaging factor is 10, replace line 60 as follows:

```
60 OUTPUT @Hp4395;"NUMG 10"
```

**How can you wait for a
measurement to be
completed?**

When you want to return the measurement data to the controller, you must wait for the measurement to be completed. For details, see Chapter 4.

```

10 !
20 !Fig.6-4 To Trigger Measurement From Controller(2)
30 !
40 ASSIGH @Hp4395 TO 717 ! When iBASIC is used, change "717" to "800"
50 OUTPUT @Hp4395;"TRGS BUS"
60 OUTPUT @Hp4395;"CONT"
70 OUTPUT @Hp4395;"*TRG"
80 END

```

Figure 6-4. Sample Program : To Trigger a Measurement from Controller (2)

Set Trigger Source

```
50 OUTPUT @Hp4395;"TRGS BUS"
```

Set the trigger source to bus.

Trigger a Measurement

```
70 OUTPUT @Hp4395;"*TRG"
```

Triggers the analyzer. When the trigger source is set to bus, you can use the group execution trigger as follows:

```
70 TRIGGER 7
```

What is Group Execution Trigger (GET)?



The HP BASIC command **TRIGGER** can be used instead of the ***TRG** command. The HP BASIC command is used to trigger all triggerable instruments on a BUS at the same time. Therefore, to trigger all triggerable instruments on select code 7(GPIB bus) execute the command:

```
TRIGGER 7
```

Setting the Gate Trigger

The gate trigger can be set via the controller, though it cannot be controlled directly. You should define Gate Length and Gate Delay as below.

- Gate Delay = $\tau/2 + SD$
- Gate Length = $\tau/4$

Where τ means Signal Length and SD means Signal. And you should measure these parameters with an oscilloscope. See *Operation Manual* for details in the gate trigger.

```
10 !
20 !Fig.6-5 Gate Trigger configure
30 !
40 ASSIGN @Hp4395 TO 717 ! When iBASIC is used, change "717" to "800"
50 OUTPUT @Hp4395;"TRGS GAT"
60 OUTPUT @Hp4395;"GATCTL LEV"
70 OUTPUT @Hp4395;"GATDLY 10E-6"
80 OUTPUT @Hp4395;"GATLEN 100E-6"
90 END
```

Figure 6-5. Sample Program : Setting the Gate Trigger

Setting the Gate Delay

```
70 OUTPUT @Hp4395;"GATDLY 10E-6"
```

Set the gate delay to 10 μ sec.

Setting the Gate Length

```
80 OUTPUT @Hp4395;"GATLEN 100E-6"
```

Set the gate length to 100 μ sec.

Using the I/O Port

This chapter describes how to use the I/O port of the analyzer with the GPIB. For general operation of the I/O port, see the *Operation Manual*.

The I/O port on the analyzer's rear panel communicates with external devices (for example, a handler on a production line). 4395A has 8 bit I/O port and 24 bit I/O port.

Overview

This section gives you an overview of the usage of the I/O port, taking the 8-bit I/O port as an example.

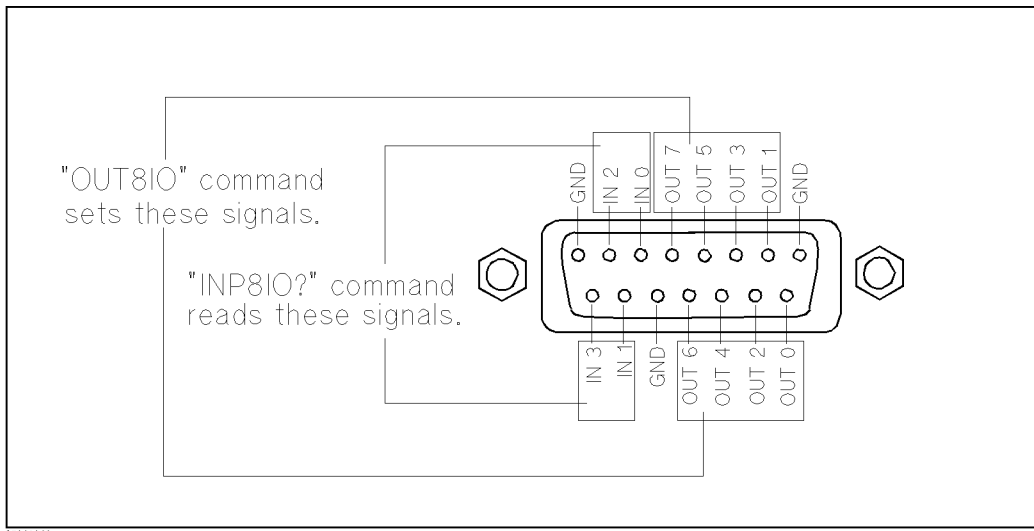

Figure 7-1. 8-bit I/O Port

The I/O port consists of the following 15 TTL compatible signals:

- 8-bit output
- 4-bit input
- 3 grounds

The signals IN 0 to IN 3 and OUT 0 to OUT 7 can be read and set by GPIB commands.

To Synchronize External Handler with Analyzer

```

10 !
20 !Fig.7-2 Synchronization of an External Handler
30 !           with the Analyzer
40 !
50 ASSIGN @Hp4395 TO 717 ! When iBASiC is used, change "717" to "800"
60 !
70 !
80 OUTPUT @Hp4395;"OUT8I0 8"
90 !
100 REPEAT                               !
110  OUTPUT @Hp4395;"INP8I0?"           !
120  ENTER @Hp4395;Inpio                 ! Waiting Handler Response
130  A=BIT(Inpio,3)                       !
140 UNTIL A=1                             !
150 !
160 !
170 END

```

Figure 7-2. Sample Program : Synchronization of an External Handler with the Analyzer

Send Signal to the External Handler

```
80 OUTPUT @Hp4395;"OUT8I0 8"
```

The `OUT8I0` parameter command sets the 8-bit data value of the OUT 0-7 lines. The `OUT8I0 8` command sets the OUT 3 line to TRUE (1).

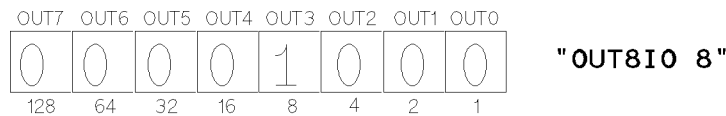

C5309004

Figure 7-3. 8-Bit Data of OUT0-7

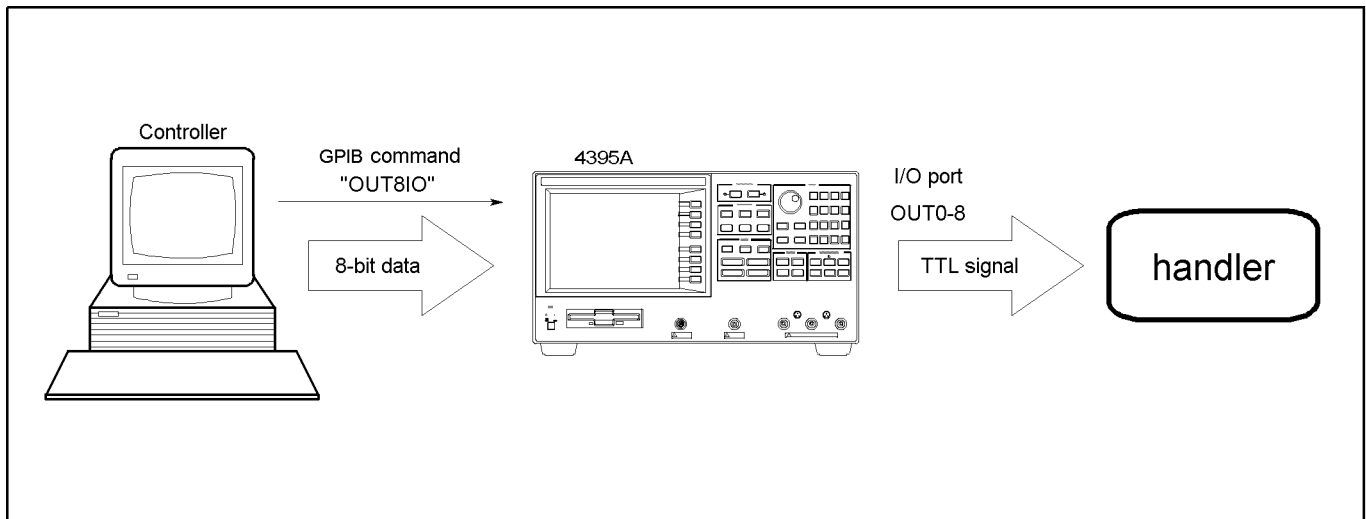

CC100701

Figure 7-4. Sending Signal to an the External Handler

Read Signal from the External Handler

```
100 REPEAT
110   OUTPUT @Hp4395;"INP8IO?"
120   ENTER @Hp4395;Inpio
130   A=BIT(Inpio,3)
140 UNTIL A=1
```

The INP8IO? command returns the 4-bit data value of the IN 0-3 lines.

Lines 100 to 140 wait for the external handler to set signal on line IN 3 to TRUE (1).

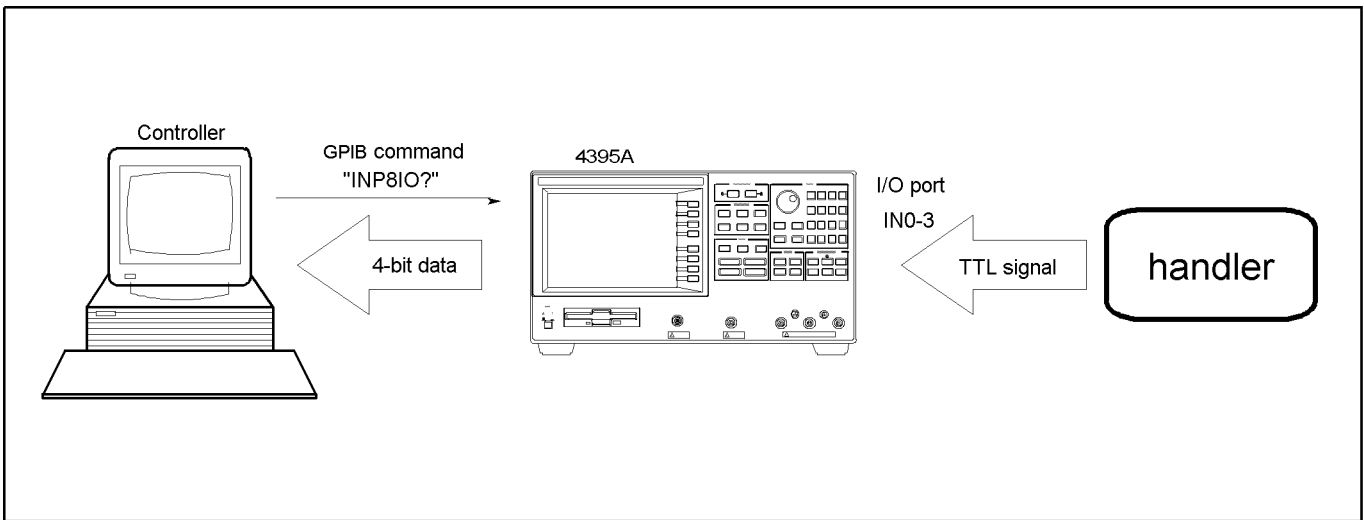

CC100702

Figure 7-5. Reading Signal from the External Handler

8-bit I/O port

The 4395A's 8-bit I/O port consists of 15 TTL level signals, which fall into 8-bit output signals, 4-bit input signals, and grounds.

I/O Pins

Figure 7-1 shows I/O pins.

The signals assigned to each pin are described below:

- OUT 0 through 7 Signal lines used to output signals to an external device. They are controlled by the command, `WRITEIO` or `OUT8IO` as described below. Once one of these commands is executed, the signal is latched until one of them is executed again.
- IN 0 through 3 Signal lines used to read an input signal from an external device. They are controlled by the command `READIO` or `INP8IO` as described below.

IBASIC Commands for the 8-bit I/O Port Control

IBASIC commands related to the 8-bit I/O port are defined as follows:

- `WRITEIO 15,0;` Outputs 8-bit data through lines OUT 0 to OUT 7. The OUT 0 signal is the LSB (least significant bit) and the OUT 7 signal is the MSB (most significant bit).
- `READIO(15,0)` Inputs 4-bit data through lines from IN 0 to IN 3 to the 4395A's memory and returns the data to an IBASIC program. The IN 0 signal is the LSB and the IN 3 signal is the MSB.

GPIB Commands for the 8-bit I/O Port Control

The GPIB commands related to the parallel I/O ports are described below:

- `OUT8IO` Outputs 8-bit data through lines OUT 0 to OUT 7. The OUT 0 signal is the LSB (least significant bit), and the OUT 7 signal is the MSB (most significant bit).
- `INP8IO?` Inputs 4-bit data through lines from IN 0 to IN 3 to the 4395As memory and returns the data to a control device such as an external controller IBASIC program. The IN 0 signal is LSB (least significant bit) and the IN 3 signal is MSB (most significant bit).

The 24-bit I/O Port

The 4395A's 24-bit I/O port has four independent parallel ports for data input or output, and several control signal and power lines. All signals are TTL level. The data I/O port consists of 2 pairs of 8-bit output ports and 2 pairs of 4-bit two-ways ports. If you use these ports together, you can use them as a 24-bit output port or as an 8-bit input port at maximum. The I/O signal is initialized to use negative logic, but it can be set to use positive logic using a GPIB command. The control signal lines consist of measurement completion output, PASS/FAIL output of limit testing results, control signal outputs for handshaking, and so on.

Note



A 36-pin cable (part number: 04278-61650) is available if you cannot connect the device directly to the connectors of the 24-bit I/O port interface on the rear panel. This cable enables a 1m cable extension of this interface.

I/O Port

The 4395A's 24-bit I/O port has following 2 pairs of output ports and 2 pairs of input/output ports.

- Output only ports

- A port: 8-bit
- B port: 8-bit

The signal is TTL level and is a latched output.

- Two ways ports

- C port: 4-bit
- D port: 4-bit

Both ports C and D are set as input ports when the 4395A is turned on. These ports can be used as output ports by using the GPIB commands `COUT` or `DOUT`. The signal is TTL level and is a latched output. (Related GPIB commands: `OUTCIO`, `OUTDIO`, `OUTPINPCIO?`, `OUTPINPDIO?`)

Using GPIB commands, you can combine these ports for use as the following ports (in addition to the above 4 ports).

- The input/output port

- E port: 8-bit (C port + D port)

- The output only ports

- F port: 16-bit (A port + B port)
- G port: 20-bit (A port + B port + C port)
- H port: 24-bit (A port + B port + C port + D port)

Control Signal Lines

The I/O ports include 10 types of output signal lines and one input signal line. These control signals are TTL-compatible (excluding the power supply line). Each of them are described below.

Port C or Port D Status Output Signal

These signals are used to report the direction setting (input or output) of port C or D to external devices. Each of these signals is set to LOW respectively when port C or D is assigned as an input port. It is set to HIGH respectively when port C or D is defined as an output port. (Related GPIB commands: `CIN`, `COUNT`, `DIN`, and `DOUT`.)

WRITE STROBE Output Signal

When data is output to any output port, a negative pulse is output to the WRITE STROBE output. This negative output pulse notifies an external device of data output to the parallel I/O port. The pulse width is 10 μs (typical). Figure 7-6 shows the timing chart for the WRITE STROBE output and data output.

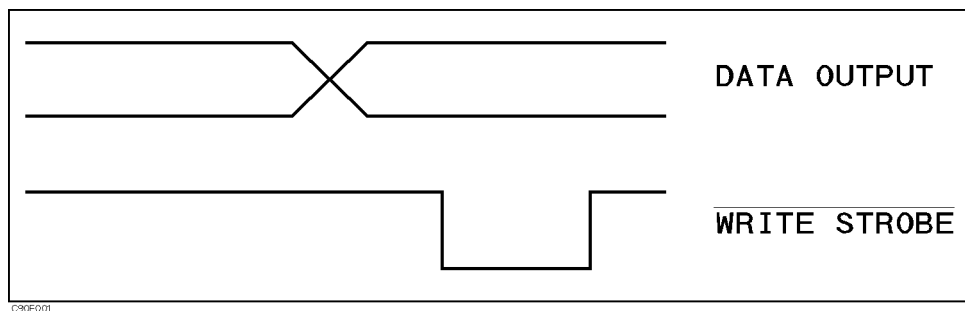

Figure 7-6. Write Strobe Signal Timing Chart

INPUT1 Input Signal

When a negative pulse is input to INPUT1, OUTPUT1 and OUTPUT2 are set to LOW or HIGH. The time interval is 200 ns (typical). An GPIB command is used to determine whether LOW or HIGH is to be set. The pulse width of the signal input to INPUT1 must be 1 μs or more. (Related GPIB commands: `OUT1ENVH`, `OUT1ENVL`, `OUT2ENVH`, `OUT2ENVL`, and `TRGOUT`.)

OUTPUT1 or OUTPUT2 Output Signal

This signal (a latch output signal) can be set to LOW or HIGH by inputting a negative pulse to INPUT1 or using an GPIB command. (Related GPIB commands: `OUT1H`, `OUT1L`, `OUT2H` and `OUT2L`.)

Note



You can change the logic level of an OUTPUT signal by synchronizing it with a measurement trigger, when you turn ON the trigger detection output function using the GPIB command `TRGOUT ON`. This function is used only in frequency transient measurements to send a load signal to a device immediately after a triggering measurement. The time interval between the measurement trigger and the logic level change is 85 μs (typical).

PASS/FAIL Output

Outputs a HIGH (positive logic) or LOW (negative logic) signal when the limit test passed, and a LOW (positive logic) or HIGH (negative logic) when the limit test failed. This is valid when the limit test function is set to ON.

WRITE STROBE Output for the PASS/FAIL Output

Outputs a negative pulse when a limit test result has been output through the PASS/FAIL output line. The output signal informs an external device of the limit test result being output through the PASS/FAIL output. The pulse width is 10 μ s (typical).

SWEEP END Output

When the 4395A completes a measurement in the Tester mode or a sweep in the Analyzer mode, a negative pulse is output. When measurements are repeated with a continuous trigger, the pulse is output at every measurement or sweep end. The pulse width is 20 μ s (typical).

+5V Output

A +5V output can be provided to an external device. The maximum current supplied is 100 mA. This line does not have a fuse. When excessive current flows, the 4395A's protection circuit automatically shuts down its internal power supply circuits. If you remove the cause of the excessive current, the 4395A's power will be turned on but the 4395A's setups are reset to the default settings.

Figure 7-7 shows the overview of I/O ports and control signal lines.

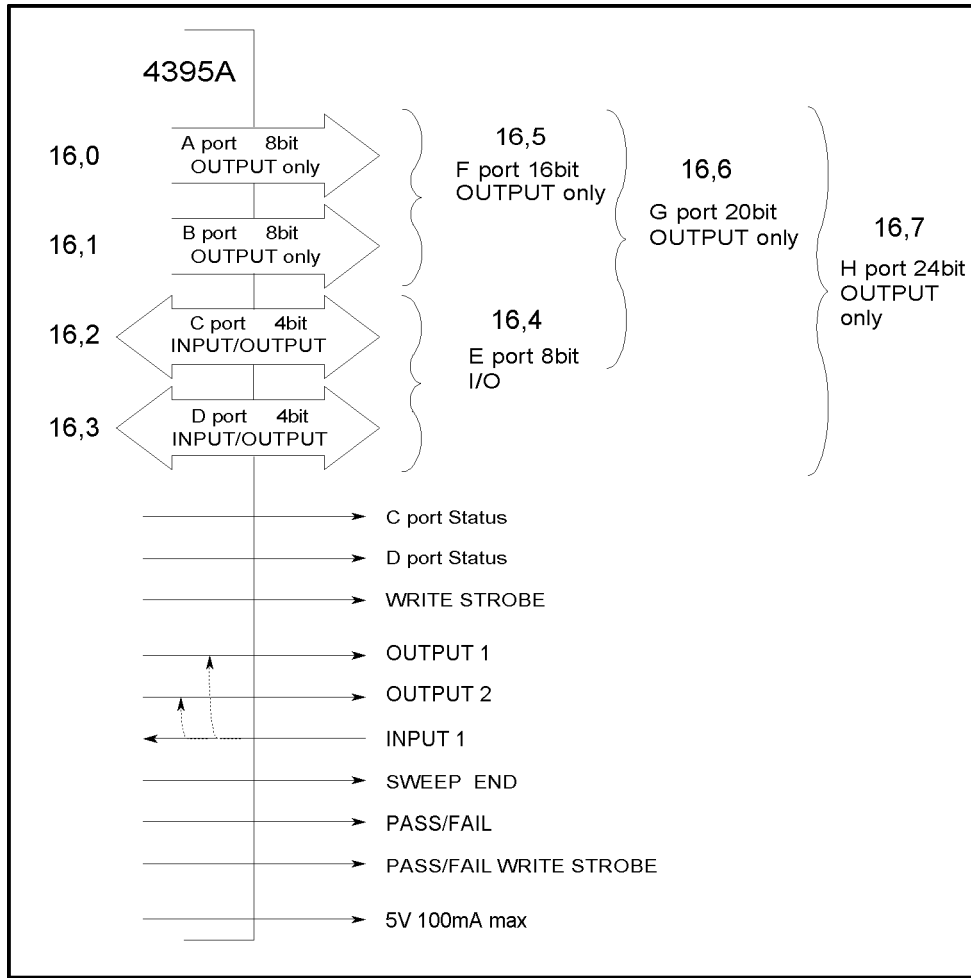

Figure 7-7. The Overview of 24-bit I/O Ports

Pin Assignment

Figure 7-8 shows the pin numbers. Table 7-1 shows the signal lines assigned to the pin numbers.

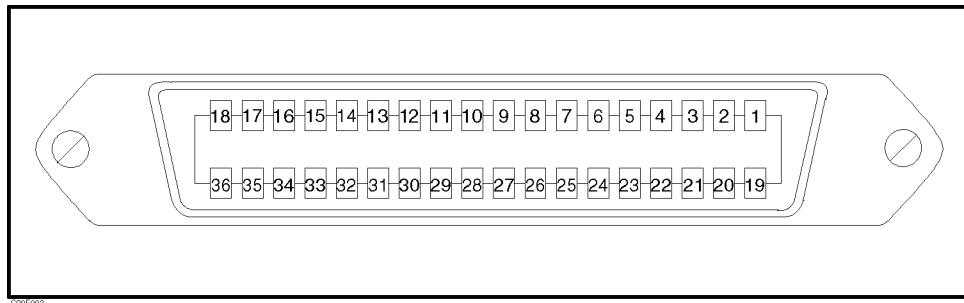

Figure 7-8. 24-bit I/O port Connector Pin Number

7-8 Using the I/O Port

Table 7-1. Assignment of Signals to Pins (Standard)

Pin No.	Signal Name	Signal Standard
1	GND	0 V
2	INPUT1	TTL level, Pulse input (Width: $\geq 1 \mu s$)
3	OUTPUT1	TTL level, Latch output
4	OUTPUT2	TTL level, Latch output
5	Output port A0	TTL level, Latch output
6	Output port A1	TTL level, Latch output
7	Output port A2	TTL level, Latch output
8	Output port A3	TTL level, Latch output
9	Output port A4	TTL level, Latch output
10	Output port A5	TTL level, Latch output
11	Output port A6	TTL level, Latch output
12	Output port A7	TTL level, Latch output
13	Output port B0	TTL level, Latch output
14	Output port B1	TTL level, Latch output
15	Output port B2	TTL level, Latch output
16	Output port B3	TTL level, Latch output
17	Output port B4	TTL level, Latch output
18	Output port B5	TTL level, Latch output
19	Output port B6	TTL level, Latch output
20	Output port B7	TTL level, Latch output
21	Input/output port C0	TTL level, Latch output
22	Input/output port C1	TTL level, Latch output
23	Input/output port C2	TTL level, Latch output
24	Input/output port C3	TTL level, Latch output
25	Input/output port D0	TTL level, Latch output
26	Input/output port D1	TTL level, Latch output
27	Input/output port D2	TTL level, Latch output
28	Input/output port D3	TTL level, Latch output
29	Port C status	TTL level, Input mode: Low, Output mode: High
30	Port D status	TTL level, Input mode: Low, Output mode: High
31	WRITE STROBE signal	TTL level, Negative logic, Pulse output (Width: $\geq 10 \mu s$ Typical)
32	+5 V pull-up	
33	SWEEP END signal	TTL level, Negative logic, Pulse output (Width: $\geq 20 \mu s$ Typical)
34	+5 V	+5 V, 100 mA max.
35	PASS/FAIL signal	TTL level, PASS: HIGH, FAIL: LOW, Latch output
36	PASS/FAIL WRITE STROBE signal	TTL level, Negative Logic, Pulse output (Width: $10 \mu s$; Typical)

Power-ON Default

The 24-bit I/O port is set to the following defaults at power-on. (These settings do not change when **Preset** is pressed.)

Logic type	Negative logic
WRITE STROBE	HIGH
signal	
SWEEP END signal	HIGH
Port A	Negative 0 → HIGH
Port B	Negative 0 → HIGH
Port C	Input
Port D	Input
OUTPUT1	HIGH, pulled HIGH by the falling edge of INPUT1 (OUT1ENVH)
OUTPUT2	HIGH, pulled HIGH by the falling edge of INPUT1 (OUT2ENVH)
PASS/FAIL signal	(Negative) → HIGH

Basic I/O circuit

Table 7-2. 24-bit I/O Port, Basic I/O Circuit

Basic circuit	Input port	
I/O pin	INPUT1	Port C, D (input) ¹
Basic circuit	Output port	Others
I/O pins	OUTPUT1, 2 port A ¹ , B ¹ , C(output) ¹ , D(output) ¹ Write strobe signal SWEEP END signal Port C status, Port D status	+5V pullup

¹ Common to all bits

IBASIC Commands for 24-bit I/O Port Control

IBASIC commands related to 24-bit I/O port are described in the following paragraphs.

Data Output

The following commands output data to the corresponding ports (A to H). If you use C, D, E, F, G, or H port as the output port, you must use the GPIB command COUT and/or DOUT to set the C and/or D port as an output port.

- WRITEIO 16,0; Output 8-bit data to port A.
- WRITEIO 16,1; Output 8-bit data to port B.
- WRITEIO 16,2; Output 4-bit data to port C.

- WRITEIO 16,3; Output 4-bit data to port D.
- WRITEIO 16,4; Output 8-bit data to port E.
- WRITEIO 16,5; Output 16-bit data to port F.
- WRITEIO 16,6; Output 20-bit data to port G.
- WRITEIO 16,7; Output 24-bit data to port H.

Data Input

The following commands read data sent from an external device to an input port (C to E) and return the value to an HP IBASIC program. If you use the port as an input port, the port must be defined as an input port using the GPIB commands CIN and/or DIN.

- READIO(16,2) Reads 4-bit data from port C and returns the value.
- READIO(16,3) Reads 4-bit data from port D and returns the value.
- READIO(16,4) Reads 4-bit data from port E and returns the value.

GPIB commands for 24-bit I/O port control

The GPIB commands related to the parallel I/O ports are summarized below.

Data Output

The following commands output data to ports (A to H). If you use C, D, E, F, G or H port as the output port, you must use the GPIB command COUT and/or DOUT to set the C, D port to output port.

- OUTAIO Outputs 8-bit data to port A.
- OUTBIO Outputs 8-bit data to port B.
- OUTCIO Outputs 4-bit data to port C.
- OUTDIO Outputs 4-bit data to port D.
- OUTEIO Outputs 8-bit data to port E.
- OUTFIO Outputs 16-bit data to port F.
- OUTGIO Outputs 20-bit data to port G.
- OUTHIO Outputs 24-bit data to port H.

Data Input

The following commands read data sent from an external device to an input port (C to E) and return the value to the GPIB. If you use the port as an input port, the port must be defined as an input port using the GPIB command CIN and/or DIN.

- OUTPINPCIO? Reads 4-bit data from port C and returns its value to the GPIB.
- OUTPINPDIO? Reads 4-bit data from port D and returns its value to the GPIB.
- OUTPINPEIO? Reads 8-bit data from port E and returns its value to the GPIB.

Setting Input/Output Directions of Ports C and D

The following commands set the input/output directions of ports C and D. When the power is turned ON, ports C and D are defined as input ports. **Preset** does not affect the setup. This setting is saved to an instrument state file using the Save function.

- CIN Defines port C as an input port.
- COUT Defines port C as an output port.
- DIN Defines port D as an input port.
- DOUT Defines port D as an output port.

7-12 Using the I/O Port

Positive or Negative Logic Setting

You can set the logic level of the following ports and signal to negative or positive using the following GPIB command **NEGL** or **POSL**. When the power is turned ON, negative logic is set. **Preset** does not affect this setup. This setup is saved to an instrument state file using the Save function.

- Output ports A to H
- Input ports C and D
- PASS/FAIL signal

OUTPUT1 and OUTPUT2 Level Setting Commands

The following commands set the logic level of OUTPUT1 and OUTPUT2.

- **OUT1H** Sets OUTPUT1 to HIGH.
- **OUT1L** Sets OUTPUT1 to LOW.
- **OUT2H** Sets OUTPUT2 to HIGH.
- **OUT2L** Sets OUTPUT2 to LOW.

Checking Input to INPUT1

This command checks whether a pulse has been input to INPUT1. Send this command after a pulse has been input to INPUT1 and the return value will be “1”. If no pulse has been input, it will be “0”. Once “1” is read by this command, it will be reset to “0” until the next pulse is input.

Application Programming

This chapter provides the application programs for 4395A. According to the analyzer mode, the programs falls into the groups shown below:

- To Read Data Using the Marker Search Function
- To Perform Limit Test
- To Set List Sweep
- To Print Analyzer Display
- Programs for the network analyzer mode:
 - To Perform 1 Pass 2 Port Calibration
 - To Analyze a Filter
 - To Analyze a Crystal Filter
 - To Measure Gain Compression
- Programs for the spectrum analyzer mode:
 - To Obtain Total Harmonic Distortion (THD)
 - To Obtain an Integral of a Power
 - To Obtain Adjacent Channel Power
 - To Obtain Occupied Power Bandwidth
 - To Calculate an S/N Ratio
- Programs for the impedance analyzer mode:
 - To Perform Calibration
 - To Measure Capacitance and the factor D
 - To Measure a Varactor Diode Using DC Bias Sweep (With Option 010)
- File transfer function
 - File transfer from the 4395A to the external controller
 - File transfer from the external controller to the 4395A
 - Listing of the files in the current directory of the 4395A

The end of this chapter lists the hints and notes for programming.

To Read Data Using the Marker Search Function

```
10      !
20      !Fig.8-1 To Read Data Using Marker Search Function
30      !
40      ASSIGN @Hp4395 TO 717 ! When iBASIC is used, change "717" to "800"
50      INPUT "ENTER CENTER FREQUENCY (Hz)",F_cent ! Setting 4395A
60      INPUT "ENTER FREQUENCY SPAN (Hz)",F_span !
70      OUTPUT @Hp4395;"CENT ";F_cent !
80      OUTPUT @Hp4395;"SPAN ";F_span !
90      OUTPUT @Hp4395;"*OPC?"
100     ENTER @Hp4395;Dum
110     !
120     OUTPUT @Hp4395;"CLES"
130     OUTPUT @Hp4395;"*SRE 4;ESNB 1"
140     ON INTR 7 GOTO Sweep_end ! \ When iBASIC is used, change "7" to "8"
150     ENABLE INTR 7;2 ! /
160     OUTPUT @Hp4395;"SING" ! Trigger a Measurement
170     Measuring: GOTO Measuring ! Measuring
180     Sweep_end: !
190     OUTPUT @Hp4395;"MKR ON"
200     OUTPUT @Hp4395;"SEAM MAX"
210     OUTPUT @Hp4395;"OUTPMKR?"
220     ENTER @Hp4395;Val1,Val2,Swp
230     PRINT "Max Val:",Val1;"dB"
240     PRINT "Swp.Prmtr:",Swp,"Hz"
250     END
```

Figure 8-1. Sample Program : Reading Data Using Marker Search Function

Searching Maximum Value

```
190     OUTPUT @Hp4395;"MKR ON"
200     OUTPUT @Hp4395;"SEAM MAX"
```

Line 190 activates the marker and line 200 moves the marker to the maximum value on the trace.

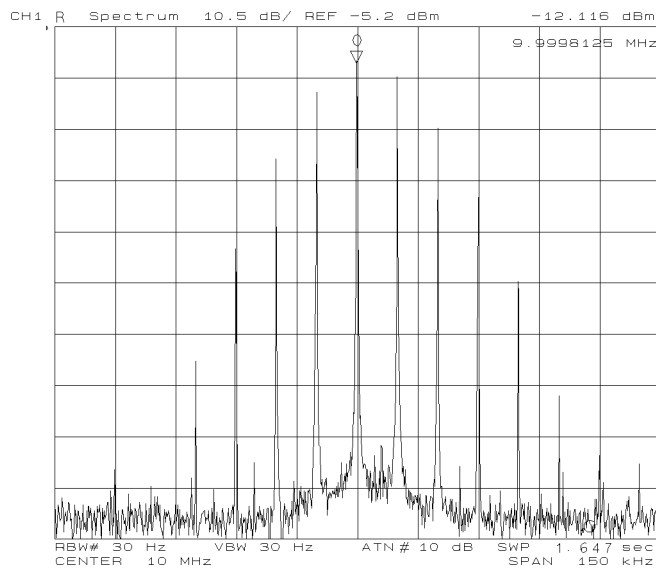

Figure 8-2. Marker on Trace

What are the other marker commands? You can activate sub-markers and the Δ marker using the following commands:

`SMKR{1-7} ON, DMKR {ON|FIX|TRAC}`

You can move the marker using the following commands:¹

- specified sweep parameter `MKRPRM parameter`
- specified measurement point `MKRP parameter`

You can move sub-markers using the following commands:¹

- specified sweep parameter `SMKRPRM{1-7} parameter`
- specified measurement point `SMKRP{1-7} parameter`

You can move the Δ marker using the following commands:¹

- specified sweep parameter `DMKRPRM parameter`
- specified primary part of marker value `DMKRVAL parameter`
- specified secondary part of marker value `DMKRAUV parameter`

¹ Before executing these commands, you must turn on the markers to be moved.

Reading Data

```
210    OUTPUT @Hp4395;"OUTPMKR?"
220    ENTER @Hp4395;Val1,Val2,Swp
```

The `OUTPMKR?` command returns the marker value in the following order: primary part of data, secondary part of data, and sweep parameter. See “Marker Readout” for details.

What are other marker value commands?

You can get the marker value using the following commands:

- get primary part of marker value `MKRVAL?`
- get secondary part of marker value `MKRAUV?`
- get sweep parameter `MKRPRM?`
- get data point number `MKRP?`

You can get the sub-marker value using the following commands:

- get primary part of sub-marker value `SMKRVAL{1-7}?`
- get secondary part of sub-marker value `SMKRAUV{1-7}?`
- get sweep parameter `SMKRPRM{1-7}?`
- get data point number `SMKRP{1-7}?`

You can get the Δ marker value using the following commands:

- get primary part of Δ marker value `DMKRVAL?`
- get secondary part of Δ marker value `DMKRAUV?`
- get sweep parameter `DMKRPRM?`

Marker Readout

The values specified by the marker, sub-marker, or delta-marker can be read using the following commands. See the following table which lists the amplitude value (value 1) and the auxiliary amplitude value (value 2) for each display format.

OUTPMKR?, Amplitude value (Value 1), Auxiliary amplitude value (Value 2), Sweep
 OUTPSMKR?, Parameter
 OUTPDMKR?
 MKRVAL?, Amplitude value (Value 1)
 SMKRVAl{1-7}?
 MKRAUV?, Auxiliary amplitude value (Value 2)
 SMKRAUV{1-7}?

Table 8-1. Marker Readout

Analyzer Type	Display Format	Parameter of CIRF Command	Amplitude Value (Value 1)	Auxiliary Amplitude Value (Value 2)
Network Analyzer	Log Magnitude	—	Log Magnitude (dB)	0
	Phase	—	Phase (degrees)	0
	Expanded Phase			
	Delay	—	Delay (seconds)	0
	Linear Magnitude	—	Linear Magnitude	0
	SWR	—	SWR	0
	Real	—	Real	0
	Imaginary	—	Imaginary	0
Network/ impedance Analyzer ¹	Smith Chart	RI	Real	Imaginary
	Polar	LIN	Linear Magnitude	Phase (degrees)
	Admittance	LOG	Log Magnitude (dB)	Phase (°)
		RX	Resistance (Ω)	Reactance (Ω)
		GB	Conductance (S)	Susceptance (S)
		SWR	SWR	Phase (°)
Spectrum Analyzer	Spectrum Measurement	—	Magnitude (dBm, dBV, dBμV, W, or V) ²	0
	Noise Level Measurement	—	Magnitude (dBm, dBV, dBμV, W, or V) ²	0

¹ For the other format than listed above in the impedance analyzer mode, the marker readout has the unit of the selected parameter by **(Meas)** key.

² Unit is specified by the **SAUNIT** command. (default: dBm)

To Perform Limit Test

```
10 !
20 !Fig.8-3 Limit Test
30 !
40 ASSIGN @Hp4395 TO 717 ! When iBASIC is used, change "717" to "800"
50 !
60 CLEAR SCREEN
70 PRINT USING "10A,15A,15A,15A";"Segment","Swp.Prmtr(Hz)","Upper","Lower"
80 !
90 DIM Table(1:18,1:3)
100 INPUT "Enter number of segments (<=18)",Numb
110 FOR I=1 TO Numb
120     GOSUB Loadlimit
130 NEXT I
140 !
150 LOOP
160     INPUT "Do you want to edit? (Y/N)",An$
170 EXIT IF An$="N" OR An$="n"
180     INPUT "Enter segment number(<=18)",I
190 IF Numb<I THEN Numb=I
200     GOSUB Loadlimit
210 END LOOP
220 !
230 OUTPUT @Hp4395;"EDITLIML"
240 OUTPUT @Hp4395;"LIMCLEL"
250 FOR K=1 TO Numb
260     OUTPUT @Hp4395;"LIMSADD"
270     OUTPUT @Hp4395;"LIMPRM ";Table(K,1)
280     OUTPUT @Hp4395;"LIMU ";Table(K,2)
290     OUTPUT @Hp4395;"LIML ";Table(K,3)
300     OUTPUT @Hp4395;"LIMSDOM"
310 NEXT K
320 OUTPUT @Hp4395;"LIMEDONE"
330 OUTPUT @Hp4395;"LIMLINE ON"
340 !
350 INPUT "Connect DUT, and press Enter.",Dum$
360 OUTPUT @Hp4395;"CLES"
370 OUTPUT @Hp4395;"*SRE 4;ESNB 1"
380 ON INTR 7 GOTO Sweep_end ! \ When iBASIC is used, change "7" to "8"
390 ENABLE INTR 7;2 ! /
400 OUTPUT @Hp4395;"SING"
410 Measuring:GOTO Measuring
420 Sweep_end: !
430 OUTPUT @Hp4395;"LIMITEST ON"
440 DIM Dt(1:801,1:4)
450 OUTPUT @Hp4395;"OUTPLINF?" ! \ Output test results.
460 ENTER @Hp4395 USING "%,K";Dt(*) ! /
470 OUTPUT @Hp4395;"OUTPFAIP?"
480 ENTER @Hp4395;Failp
490 IF Failp=0 THEN Passed
500 PRINT "          FAIL POINTS          "
510 FOR I=1 TO Failp
520     PRINT
530     PRINT "Swp. prmtr : ";Dt(I,1)
540     PRINT "  Results      Upper      Lower      "
550     PRINT TAB(5);Dt(I,2);TAB(17);Dt(I,3);TAB(32);Dt(I,4)
560 NEXT I
570 Passed: !
580 DISP "Program End"
```

Figure 8-3. Sample Program : Limit Test (1/2)

```

590 STOP
600 !
610 Loadlimit: !
620 INPUT "ENTER SWEEP PARAMETER (Hz)",Table(I,1)
630 INPUT "ENTER UPPER LIMIT VALUE",Table(I,2)
640 INPUT "ENTER LOWER LIMIT VALUE",Table(I,3)
650 PRINT I;TAB(11);Table(I,1);TAB(27);Table(I,2);TAB(42);Table(I,3)
660 RETURN
670 END

```

Figure 8-1. Sample Program : Limit Test (2/2)

Lines 60 and 70 print the limit table heads on the BASIC SCREEN.

Line 90 defines the table (array `Table(1:18,1:3)`) used to hold the limit values. It contains the sweep parameter, the upper limit value, and the lower limit value as follows:

Segment	Sweep Parameter	Upper Limit	Lower Limit
1	Table(1,1)	Table(1,2)	Table(1,3)
2	Table(2,1)	Table(2,2)	Table(2,3)
⋮	⋮	⋮	⋮

Lines 110 to 130 call the subroutine `Loadlimit` (line 610) to edit and print as many segments as you defined in line 100 (the analyzer can retain up to 18 segments).

Segment	Swp.Prmtr(Hz)	Upper	Lower
1	2.E+6	0	-10
2	3.E+6	10	-20
3	4.E+6	10	-10

The loop, lines 150 to 210, determines if you want to edit the table and confirms that the segment is in the table.

Lines 230 to 330 transfers the limit table (edited using BASIC) to the analyzer (more specifically, lines 260 to 300 define the segmentation and the other lines establish the limit line).

The `OUTPLIMF?` command in line 450 returns the limit test result for failed points. The test results are in the following order: sweep parameter, result (0 for fail, -1 for no test), upper limit, and lower limit.

The `OUTPFAIP?` command in line 470 returns the number of failed points. (When the limit test result is PASS, it returns 0 and the program goes to `Passed`.) Then the array `Dt` is printed with as many lines as the transferred data.

Lines 510 to 560 print the limit test result as follows:

```

Swp.Prmtr(Hz) : 1.1925E+7
  Result      Upper      Lower
    0         20        -40

Swp.Prmtr(Hz) : 1.2125E+7
  Result      Upper      Lower
    0         20        -40

```

What are other commands used to retrieve the test results? Instead of reading the limit test results for failed points by using the `OUTPLIMF?` command, you can read out the test result using the following commands:

- At all measurement points: `OUTPLIML?`
- At marker position: `OUTPLIMM?`

Both commands return the sweep parameter, result (1 for pass, 0 for fail, -1 for no test), upper limit, and lower limit.

To Set List Sweep

```
10 !
20 !Fig.8-4 List Sweep
30 !
40 ASSIGN @Hp4395 TO 717 ! When iBASIC is used, change "717" to "800"
50 !
60 OUTPUT @Hp4395;"SA"
70 CLEAR SCREEN
80 PRINT "Segment";TAB(9);"Center(Hz)";TAB(20);"Span(Hz)";TAB(30);"Points";
90 PRINT TAB(39);"Power(dBm)";TAB(50);"RBW(Hz)"
100 !
110 DIM Table(1:31,1:5)
120 INPUT "Enter number of segments (<=15)",Numb
130 FOR I=1 TO Numb
140   GOSUB Loadlist
150 NEXT I
160 !
170 LOOP
180   INPUT "Do you want to edit? (Y/N)",An$
190   EXIT IF An$="N" OR An$="n"
200   INPUT "Enter segment number(<=15)",I
210   IF Numb<I THEN Numb=I
220   GOSUB Loadlist
230 END LOOP
240 !
250 OUTPUT @Hp4395;"EDITLIST"
260 OUTPUT @Hp4395;"CLEL"
270 FOR K=1 TO Numb
280   OUTPUT @Hp4395;"SADD"
290   OUTPUT @Hp4395;"CENT ";Table(K,1)
300   OUTPUT @Hp4395;"SPAN ";Table(K,2)
310   OUTPUT @Hp4395;"POIN ";Table(K,3)
320   OUTPUT @Hp4395;"POWE ";Table(K,4)
330   OUTPUT @Hp4395;"BW ";Table(K,5)
340   OUTPUT @Hp4395;"SDON"
350 NEXT K
360 OUTPUT @Hp4395;"EDITDONE"
370 OUTPUT @Hp4395;"SWPT LIST"
380 !
390 INPUT "Connect DUT, and press Enter.",Dum$
400 OUTPUT @Hp4395;"CLES"
410 OUTPUT @Hp4395;"*SRE 4;ESWB 1"
420 ON INTR 7 GOTO Sweep_end ! \ When iBASIC is used, change "7" to "8"
430 ENABLE INTR 7;2 ! /
440   OUTPUT @Hp4395;"SING"
450 Measuring:GOTO Measuring
460 Sweep_end: !
470 DISP "Program End"
480 STOP
490 !
500 Loadlist: !
510 INPUT "Enter center frequency(Hz)",Table(I,1)
520 INPUT "Enter frequency span(Hz)",Table(I,2)
530 INPUT "Enter number of points",Table(I,3)
540 INPUT "Enter power level(dBm)",Table(I,4)
550 INPUT "Enter resolution band width(Hz)",Table(I,5)
560 PRINT I;TAB(11);Table(I,1);TAB(20);Table(I,2);TAB(30);Table(I,3);
570 PRINT TAB(40);Table(I,4);TAB(50);Table(I,5)
580 RETURN
590 END
```

Figure 8-4. Sample Program : List Sweep

Lines 70 to 90 print the list table heads on the BASIC screen.

Line 110 defines the table (array `Table(1:31,1:5)`) used to hold the list values. It contains the center frequency, frequency span, number of points, power level, and resolution band width of each segment as follows:

Segment	Center Frequency	Frequency Span	Number of Points	Power Level	Resolution Band Width
1	Table(1,1)	Table(1,2)	Table(1,3)	Table(1,4)	Table(1,5)
2	Table(2,1)	Table(2,2)	Table(2,3)	Table(2,4)	Table(2,5)
⋮	⋮	⋮	⋮	⋮	⋮

Lines 130 to 150 call the subroutine `Loadlist` (line 500) to edit and print as many segments as you defined in line 120 (The analyzer can retain up to 15 segments in the spectrum analyzer mode, up to 51 segments in the other analyzer modes).

Segment	Center(Hz)	Stop(Hz)	Points	Power(dBm)	RBW(Hz)
1	100	20	100	0	100
2	10000	1000	300	0	300
3	1000000	1000	400	0	100

The loop, lines 170 to 230, determines if you want to edit the table and confirms that the segment is in the table.

Lines 250 to 370 transfers the list table (edited using BASIC) is to the analyzer (more specifically, lines 280 to 340 define the segmentation and the other lines establish the list table).

What are other commands are used to set the list values?

- When setting segment frequencies, instead of setting the center/span definition by using the `CENT parameter / SPAN parameter` commands, you can define start/stop frequency by using:
 1. `STAR parameter / STOP parameter` commands
 2. `MKRSTAR / MKRSTOP` commands (Maker to start/stop)
- When setting the IF band width (with the analyzer in network analyzer mode), use the `BW parameter` command.

To Print Analyzer Display

This section describes how to print the information on the analyzer display using GPIB commands.

Printer Preparation

1. Connect a printer using a parallel cable.
2. Turn the printer on.

Execute Print

To print the screen, execute the following command.

```
OUTPUT 717;"PRINALL"
```

Set the GPIB address when you execute from an external controller.

To Observe Printing

The HP Basic program shown below gives an example to detect printing end by using an SRQ interrupt. The interrupt is generated upon the printing bit of the operation status event register is enabled.

```
10  !
20  !Fig.8-5  To Observe Printing
30  !
40  ASSIGN @Hp4395 TO 717 ! When iBASIC is used, change "717" to "800".
50  !
60  OUTPUT @Hp4395;"CLES"
70  OUTPUT @Hp4395;"OSWT 512" !Catch High to Low Transition
80  OUTPUT @Hp4395;"OSPT 0"  !Disable Low to High Transitions
90  OUTPUT @Hp4395;"OSE 512" !Enable OS Event Reg.
100 OUTPUT @Hp4395;"*SRE 128" !Enable OSR bit
120 ON INTR 7 GOTO La1
130 ENABLE INTR 7;2
140 OUTPUT @Hp4395;"PRINALL"
150 La1:!
160 GOTO La1
170 DISP "PRINT COMPLETE"
180 !
190 END
```

Figure 8-5. Sample Program : To Observe Printing

Programs for the Network Analyzer Mode

To Perform 1 Pass 2 Port Calibration

The sample program in this section performs 1 pass 2 port calibration, one of the variety of calibrations available for the 4395A in the network analyzer mode.

```
10 !
20 !Fig.8-6 1PASS 2PORT CALIBRATION
30 !
40 ASSIGN @Hp4395 TO 717 ! When iBASIC is used, change "717" to "800".
50 !
60 OUTPUT @Hp4395;"PRES"
70 OUTPUT @Hp4395;"NA"
100 !
110 Cal_1p2p: !
120 CLEAR SCREEN
130 BEEP
140 PRINT "One Path 2 Port CAL"
150 PRINT " 1:Reflect'N"
160 DISP "Open cal :press continue"
170 PAUSE
180 OUTPUT @Hp4395;"CALI ONE2;REFL;CLASS11A"
190 OUTPUT @Hp4395;"*OPC?"
200 ENTER @Hp4395;Dummy
210 DISP "Short cal :press continue"
220 PAUSE
230 OUTPUT @Hp4395;"CLASS11B"
240 OUTPUT @Hp4395;"*OPC?"
250 ENTER @Hp4395;Dummy
260 DISP "Load cal :press continue"
270 PAUSE
280 OUTPUT @Hp4395;"CLASS11C"
290 OUTPUT @Hp4395;"*OPC?"
300 ENTER @Hp4395;Dummy
310 OUTPUT @Hp4395;"REFD" ! SAVE Reflect'N Result
320 OUTPUT @Hp4395;"*OPC?"
330 ENTER @Hp4395;Dummy
340 !
350 BEEP
360 PRINT " 2:Transmission"
370 DISP "CONNCT THRU and press continue"
380 PAUSE
390 OUTPUT @Hp4395;"TRAN;FWDI"
400 OUTPUT @Hp4395;"*OPC?"
410 ENTER @Hp4395;Dummy
420 OUTPUT @Hp4395;"FWDM"
430 OUTPUT @Hp4395;"*WAI"
440 OUTPUT @Hp4395;"TRAD" ! SAVE Transmission
450 OUTPUT @Hp4395;"*OPC?"
460 ENTER @Hp4395;Dummy
470 !
480 ! ISOLATION
490 Num=1
500 BEEP
```

Figure 8-6. Sample Program : 1 Pass 2 Port Calibration (1/2)

```

510 PRINT " 3:Isolation"
520 INPUT " Select number, 1:OMIT or 2:FWD ISOL'N",Num
530 SELECT Num
540 CASE 1
550 OUTPUT @Hp4395;"ISOL;OMI" ! Omits Isolation
560 CASE 2
570 DISP "Connect STD, then press continue"
580 PAUSE
590 OUTPUT @Hp4395;"ISOL;FWDI" ! Measure Isolation Standard
600 CASE ELSE
610 BEEP
620 GOTO 520
630 END SELECT
640 OUTPUT @Hp4395;"*WAI"
650 OUTPUT @Hp4395;"ISOD" ! SAVE Isolation
660 OUTPUT @Hp4395;"*WAI"
670 OUTPUT @Hp4395;"SAV2" ! SAVE CAL DATA
680 OUTPUT @Hp4395;"*OPC?"
690 ENTER @Hp4395;Dummy
700 !
710 DISP "PROGRAM END"
720 END

```

Sample Program : 1 Pass 2 Port Calibration (2/2)

The measurement and calibration should be performed with the controller

When performing calibration, each calibration factor should be measured and stored in synchronization with the controller. See Chapter 4 for the detailed procedure required to synchronize with the controller.

For detailed information on the calibration, see *Operation Manual*.

To Analyze a Filter

The sample program in this section performs the waveform analysis of a bandpass filter. The filter is assumed to have a frequency characteristic shown below.

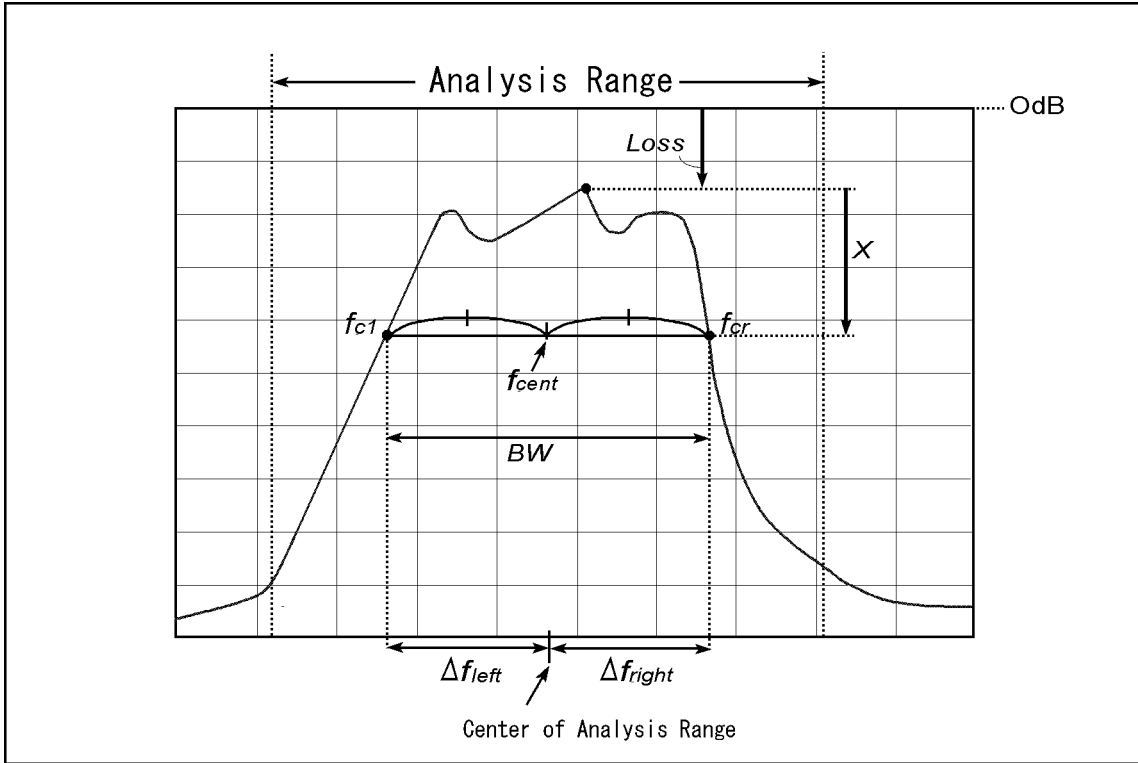

Figure 8-7. Conceptual View of a Bandpass-filtered Waveform

The table below lists the results obtained from the program.

Parameter	Description
<i>Loss</i>	Insertion loss
<i>BW</i>	<i>x</i> dB down bandwidth
<i>f_{cent}</i>	Center frequency
<i>Q</i>	Q (Quality factor)
Δf_{left}	Frequency difference between the left cutoff point and the middle of the analysis range.
Δf_{right}	Frequency difference between the right cutoff point and the middle of the analysis range.

Q is calculated using the following equation:

$$Q = \frac{\sqrt{f_{cl} \times f_{cr}}}{BW}$$

```

10 !Fig.8-8 To Analyze A Filter
20 ASSIGN @Agt4395 TO 717 ! When iBASIC is used, change "717" to "800"
30 !
40 Center=7.E+7
50 Spanv=200000.
60 !
70 OUTPUT @Agt4395;"PRES"
80 OUTPUT @Agt4395;"DISA HIHB"
90 GOSUB Setup
100 GOSUB Calibration
110 GOSUB Measurement
120 DISP "PROGRAM END"
130 STOP
140 !
150 Setup:!
160   OUTPUT @Agt4395;"NA"
170   OUTPUT @Agt4395;"MEAS BR"
180   OUTPUT @Agt4395;"CENT ";Center
190   OUTPUT @Agt4395;"SPAN ";Spanv
200   OUTPUT @Agt4395;"*OPC?"
210   ENTER @Agt4395;Dummy
220 RETURN
230 !
240 Calibration: !
250 CLEAR SCREEN
260   BEEP
270   PRINT "Calibration"
280   OUTPUT @Agt4395;"CALI RESP"
290   DISP "Thru cal :press continue"
300   PAUSE
310   OUTPUT @Agt4395;"STANC"
320   OUTPUT @Agt4395;"*WAI"
330   OUTPUT @Agt4395;"RESPDONE"      ! SAVE CAL DATA
340   OUTPUT @Agt4395;"*OPC?"
350   ENTER @Agt4395;Dummy
360 RETURN
370 !
380 !
390 Measurement: !
400 CLEAR SCREEN
410   BEEP
420   DISP "CONNECT DEVICE (FILTER) and press continue"
430   PAUSE
440   OUTPUT @Agt4395;"SING"
450   OUTPUT @Agt4395;"*OPC?"
460   ENTER @Agt4395;Dummy
470   OUTPUT @Agt4395;"AUTO"
480   !
490   ! Anarisys range configuration
500   BEEP
510   Lowerl=6.9E+7
520   Higherl=7.1E+7
530   PRINT
540   PRINT "ANARISYS RANGE"
550   PRINT Lowerl;" - ";Higherl
560   INPUT "Change analysis range? Y/N",A$
570   IF A$="Y" THEN
580     INPUT "Lower limit [Hz]",Lowerl
590     INPUT "Higher limit [Hz]",Higherl
600   END IF
610   OUTPUT @Agt4395;"MKR ON;MKRO DATA"

```

Figure 8-8. Sample Program : To Analyze a Filter (1/2)

```

620 OUTPUT @Agt4395;"MKRPRM ";Lowerl
630 OUTPUT @Agt4395;"DMKR ON"
640 OUTPUT @Agt4395;"MKRPRM ";Higherl
650 OUTPUT @Agt4395;"SEARSTR"
660 OUTPUT @Agt4395;"PARS ON"
670 !
680 OUTPUT @Agt4395;"SEAM MAX"
690 !
700 OUTPUT @Agt4395;"DMKR ON"
710 OUTPUT @Agt4395;"WIDVTYPE FIX"
720 Trgv=-3
730 INPUT "Input cut-off value[dB]",Trgv
740 OUTPUT @Agt4395;"WIDV ";Trgv;"DB"
750 OUTPUT @Agt4395;"WIDT ON"
760 !
770 OUTPUT @Agt4395;"OUTPWID?"
780 ENTER @Agt4395;A,B,C
790 Lfreq=B-A/2-(Higherl+Lowerl)/2
800 Rfreq=B+A/2-(Higherl+Lowerl)/2
810 OUTPUT @Agt4395;"MKRVAL?"
820 ENTER @Agt4395;Loss
830 !
840 PRINT "RESULT"
850 PRINT "======"
860 PRINT "BAND WIDTH : ";A;"Hz"
870 PRINT "CENTER : ";B;"Hz"
880 PRINT "Quality : ";C
890 PRINT "Loss : ";Loss;"dB"
900 PRINT "deltaL. F : ";Lfreq;"Hz"
910 PRINT "deltaR. F : ";Rfreq;"Hz"
920 RETURN
930 !
940 END

```

Sample Program : To Analyze a Filter (2/2)

Lines 240 to 360 performs calibration. This sample program performs THRU calibration. An appropriate calibration should be applied depending on your DUT.

This program employs the width function of the marker. When this function is enabled, the same information as the output of this program will appear on the display of the 4395A.

Lines 490 to 660 specify the range of marker search.

Lines 680 to 800 calculate the bandwidth (BW), center frequency of the bandwidth (cent), Q factor (Q), left hand bandwidth ($\Delta L.F$), and right hand bandwidth ($\Delta R.F$) using the bandwidth search function of the marker.

Lines 810 to 820 calculate the insertion loss.

To Analyze a Crystal Filter

The sample program in this section performs a waveform analysis of a bandpass filter which has a passband ripple, such as a crystal filter. Before running this program, verify the analysis range, that is the measurement range where you wish to obtain the spurious and rejection levels. The information can be specified when prompted by the program.

- Spurious level is the frequency difference from the insertion loss to the maximum level between f_2 and the right edge of analysis range (f_2 can take a value in the program).

- Rejection level is the frequency difference from the insertion loss to the maximum level in the range from the left edge of analysis range to f_l (f_l can take a value in the program).

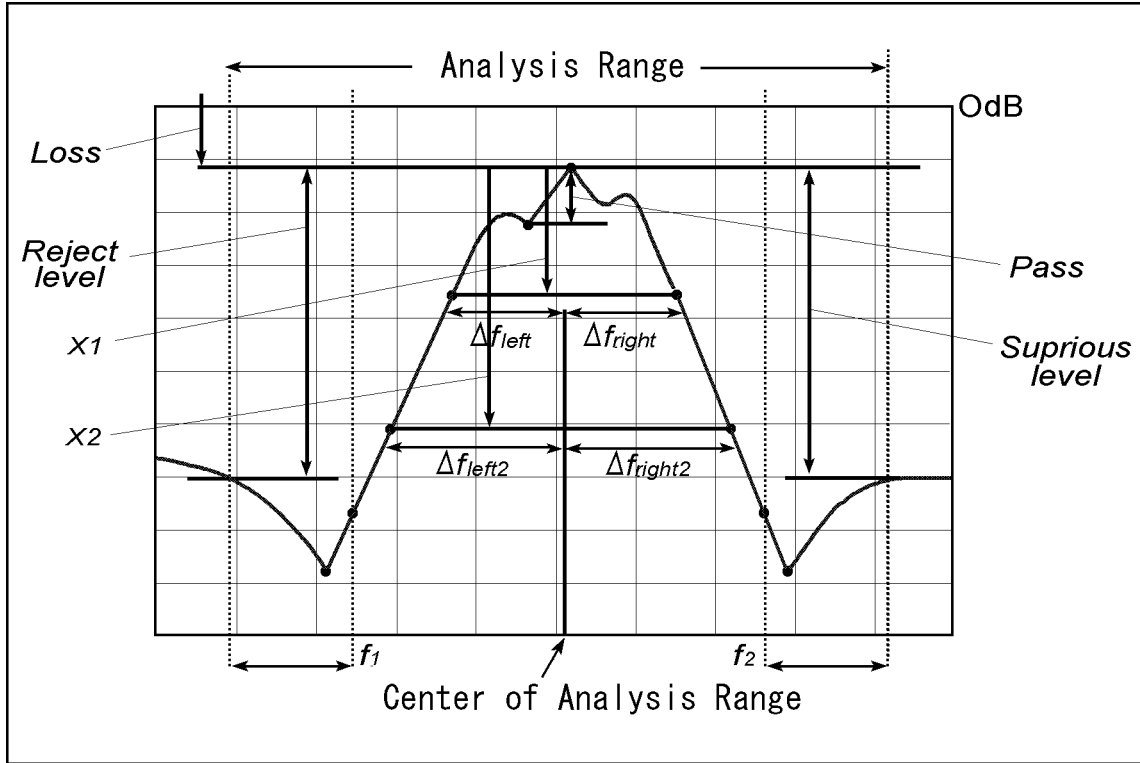

Figure 8-9. Analyzing a Crystal Filter

The table below lists the results obtained from the program.

Parameter	Description
<i>Loss</i>	Insertion loss
<i>BW</i>	x_1 dB down bandwidth
f_{cent}	Center frequency
<i>Q</i>	Q
Δf_{left}	Frequency difference between the left cutoff point (f_{cl}) and the middle of the range.
Δf_{right}	frequency difference between the right cutoff point (f_{cr}) and the middle of the range.
Δf_{left2}	Frequency difference between the left cutoff point (f_{cl2}) and the middle of the range.
Δf_{right2}	frequency difference between the left cutoff point (f_{cr2}) and the middle of the range.
<i>Pass</i>	Passband ripple
<i>Reject</i>	Rejection level
<i>Spurious</i>	Spurious level
$Pole_{x1}$	First negative peak found to the left of the maximum point.
$Pole_{stim1}$	Stimulus of $Pole_{x1}$.
$Pole_{x2}$	First negative peaks found to the right of the maximum point.
$Pole_{stim2}$	Stimulus of $Pole_{x2}$.

```

10 !
20 !Fig.8-10 Xtal filater analisys
30 !
40 ASSIGN @Hp4395 TO 717 !When iBASIC is used, change "717" to "800"
50 !
60 Center=7.E+7
70 Spanv=200000.
80 Trgv(1)=-3 ! 1st cut off value [dB]
90 Trgv(2)=-6 ! 2nd cut off value [dB]
100 D=-50 ! Pole value [dB]
110 F1=6.998E+7 ! Range parameter to get reject level [Hz]
120 F2=7.003E+7 ! Range parameter to get suprious level [Hz]
130 !
140 !
150 OUTPUT @Hp4395;"PRES"
160 OUTPUT @Hp4395;"DISA HIHB"
170 GOSUB Setup
180 GOSUB Calibration
190 GOSUB Measurement
200 STOP
210 !
220 Setup: !
230 OUTPUT @Hp4395;"NA"
240 OUTPUT @Hp4395;"MEAS BR"
250 OUTPUT @Hp4395;"CENT ";Center
260 OUTPUT @Hp4395;"SPAN ";Spanv
270 OUTPUT @Hp4395;"*OPC?"
280 ENTER @Hp4395;Dummy
290 RETURN
300 !
310 Calibration: !
320 CLEAR SCREEN
330 BEEP
340 PRINT "Calibration"
350 OUTPUT @Hp4395;"CALI RESP"
360 DISP "Thru cal :press continue"
370 PAUSE
380 OUTPUT @Hp4395;"STANC"
390 OUTPUT @Hp4395;"*WAI"
400 OUTPUT @Hp4395;"RESPDOWE" ! SAVE CAL DATA
410 OUTPUT @Hp4395;"*OPC?"
420 ENTER @Hp4395;Dummy
430 RETURN
440 !
450 Measurement: !
460 DIM Trgv(2),Lfreq(2),Rfreq(2)
470 CLEAR SCREEN
480 BEEP
490 DISP "CONNECT DEVICE (FILTER) and press continue"
500 PAUSE
510 OUTPUT @Hp4395;"SING"
520 OUTPUT @Hp4395;"*OPC?"
530 ENTER @Hp4395;Dummy
540 OUTPUT @Hp4395;"AUTO"
550 !
560 ! Anarisys range configuration
570 BEEP
580 Lowerl=6.995E+7
590 Higherl=7.006E+7
600 PRINT
610 PRINT "ANARISYS RANGE"

```

Figure 8-10. Sample Program : Crystal Filter Analysis (1/4)

```

620 PRINT Lowerl;" - ";Higherl
630 INPUT "Do you change this range? Y/N",A$
640 IF A$="Y" THEN
650 INPUT "Lower limit",Lowerl
660 INPUT "Higher limit",Higherl
670 GOTO 610
680 END IF
690 OUTPUT @Hp4395;"MKR ON;MKRO DATA"
700 OUTPUT @Hp4395;"MKRPRM ";Lowerl
710 OUTPUT @Hp4395;"DMKR ON"
720 OUTPUT @Hp4395;"MKRPRM ";Higherl-Lowerl
730 OUTPUT @Hp4395;"SEARSTR"
740 OUTPUT @Hp4395;"PARS ON"
750 !
760 OUTPUT @Hp4395;"SEAM MAX"
770 OUTPUT @Hp4395;"DMKR ON"
780 OUTPUT @Hp4395;"WIDVTYPE FIX"
790 OUTPUT @Hp4395;"WIDT ON"
800 FOR I=1 TO 2
810 OUTPUT @Hp4395;"WIDV ";Trgv(I)
820 OUTPUT @Hp4395;"OUTPMWID?"
830 ENTER @Hp4395;A,B,C
840 Lfreq(I)=B-A/2
850 Rfreq(I)=B+A/2
860 IF I=1 THEN Bw=A
870 NEXT I
880 OUTPUT @Hp4395;"MKRVAL?"
890 ENTER @Hp4395;Loss
900 OUTPUT @Hp4395;"WIDT OFF"
910 OUTPUT @Hp4395;"SMKR1 OFF;SMKR2 OFF;SMKR3 OFF"
920 !
930 ! Pass level serch
940 OUTPUT @Hp4395;"PKTHVAL ";Trgv(2)
950 OUTPUT @Hp4395;"PKTHRE ON"
960 OUTPUT @Hp4395;"PKPOL NEG"
970 OUTPUT @Hp4395;"SEAM PEAK"
980 OUTPUT @Hp4395;"SEANPKL"
990 OUTPUT @Hp4395;"MKRVAL?"
1000 ENTER @Hp4395;Ripplel
1010 OUTPUT @Hp4395;"MKRPRM?"
1020 ENTER @Hp4395;Stimmax
1030 OUTPUT @Hp4395;"SEANPKR"
1040 OUTPUT @Hp4395;"SMKRVAL1?"
1050 ENTER @Hp4395;Rippler
1060 IF Ripplel<Rippler THEN
1070 Pass=Ripplel-Loss
1080 ELSE
1090 Pass=Rippler-Loss
1100 END IF
1110 OUTPUT @Hp4395;"PKTHRE OFF"
1120 !
1130 ! Pole search
1140 Polel=0
1150 Xstiml=0
1160 Poler=0
1170 Xstimr=0
1180 OUTPUT @Hp4395;"CLES"
1190 OUTPUT @Hp4395;"*OPC?"
1200 ENTER @Hp4395;Dummy
1210 OUTPUT @Hp4395;"*SRE 4;ESNB 96"
1220 ON INTR 7 GOTO End_search ! \Set-up to Exit when fails to search poles.

```

Sample Program : Crystal Filter Analysis (2/4)

```

1230  ENABLE INTR 7;2          ! /When iBASIC, change "7" to "8"
1240  OUTPUT @Hp4395;"SEAM PEAK"
1250  LOOP
1260    OUTPUT @Hp4395;"SEANPKL"
1270    OUTPUT @Hp4395;"MKRVAL?"
1280    ENTER @Hp4395;Polel
1290    OUTPUT @Hp4395;"MKRPRM?"
1300    ENTER @Hp4395;Xstiml
1310  EXIT IF Polel<D AND Xstiml<Stimmax
1320  END LOOP
1330  LOOP
1340    OUTPUT @Hp4395;"SEANPKR"
1350    OUTPUT @Hp4395;"MKRVAL?"
1360    ENTER @Hp4395;Poler
1370    OUTPUT @Hp4395;"MKRPRM?"
1380    ENTER @Hp4395;Xstimr
1390  EXIT IF Poler<D AND Xstimr>Stimmax
1400  END LOOP
1410 End_search:  !
1420  IF Xstiml=0 AND Xstimr=0 THEN PRINT "No Pole!"
1430  !
1440  OUTPUT @Hp4395;"MKRPRM ";F2
1450  OUTPUT @Hp4395;"MKRVAL?"
1460  ENTER @Hp4395;Sup_ref
1470  !
1480  ! Reject level search
1490  IF F1-Lowerl<0 THEN GOTO Printing
1500  OUTPUT @Hp4395;"MKRPRM";Lowerl
1510  OUTPUT @Hp4395;"MKRVAL?"
1520  ENTER @Hp4395;Rej_ref
1530  OUTPUT @Hp4395;"DMKR ON"
1540  OUTPUT @Hp4395;"MKRPRM";F1-Lowerl
1550  OUTPUT @Hp4395;"SEARSTR"
1560  OUTPUT @Hp4395;"SEAM MAX"
1570  OUTPUT @Hp4395;"MKRVAL?"
1580  ENTER @Hp4395;Reject
1590  Reject=Reject+Rej_ref
1600  !
1610  ! Spurious level search
1620  OUTPUT @Hp4395;"MKRPRM";F2-Lowerl
1630  OUTPUT @Hp4395;"DMKR ON"
1640  IF Higherl-F2<0 THEN GOTO Printing
1650  OUTPUT @Hp4395;"MKRPRM";Higherl-F2
1660  OUTPUT @Hp4395;"SEARSTR"
1670  OUTPUT @Hp4395;"SEAM MAX"
1680  OUTPUT @Hp4395;"MKRVAL?"
1690  ENTER @Hp4395;Sprious
1700  Sprious=Sprious+Sup_ref
1710  !
1720  Printing: !
1730  IF F1<Lowerl OR F2>Higherl THEN PRINT "F1 or F2 is invalid"
1740  PRINT "RESULT"
1750  PRINT "===== "
1760  PRINT "BAND WIDTH (1st val.) : ";Bw;"Hz"
1770  PRINT "CENTER : ";B;"Hz"
1780  PRINT "Quality : ";C
1790  PRINT "LOSS : ";Loss;"dB"
1800  PRINT "deltaL. F1 : ";Lfreq(1);"Hz"
1810  PRINT "deltaR. F1 : ";Rfreq(1);"Hz"
1820  PRINT "deltaL. F2 : ";Lfreq(2);"Hz"
1830  PRINT "deltaR. F2 : ";Rfreq(2);"Hz"

```

Sample Program : Crystal Filter Analysis (3/4)

```

1840 PRINT "PASS                : ";Pass;"dB"
1850 PRINT "REJECT              : ";Reject;"dB"
1860 PRINT "SPRIOUS             : ";Sprious;"dB"
1870 PRINT "Right POLE Value    : ";Pole1;"dB"
1880 PRINT "Right POLE Stimuras : ";Xstimr;"Hz"
1890 PRINT "Left POLE Value     : ";Pole1;"dB"
1900 PRINT "Left POLE Stimuras  : ";Xstiml;"Hz"
1910 !
1920 DISP "PROGRAM END"
1930 !
1940 END

```

Sample Program : Crystal Filter Analysis (3/4)

This program is an enhancement of the “To Analyze a Filter” program. So lines 150 to 890 work same as the “To Analyze a Filter” program.

Lines 1130 to 1410 calculate the Ripple value of the filter.

Lines 1130 to 1410 calculate the Pole value of the filter. In this routine, when 4395A fails to search Poles, lines 1180 to 1220 let 4395A know it using with SRQ. About SRQ, see “To Wait for Sweep End” in Chapter 5.

Lines 1470 to 1580 calculate Rejection level and line 1600 to 1690 calculate Sprious level.

To Measure Gain Compression

The sample program in this section measures gain compression using the power sweep function. This program uses two channels. One channel is used to measure an absolute value of the output signal from the DUT. The other channel measures a ratio of the input and output signal levels. The program shows the power level of the input and output signal at the -1 dB gain compression point.

In the figure below, the marker shows the input and output power levels at the -1 dB gain compression point relative to the left Δ marker.

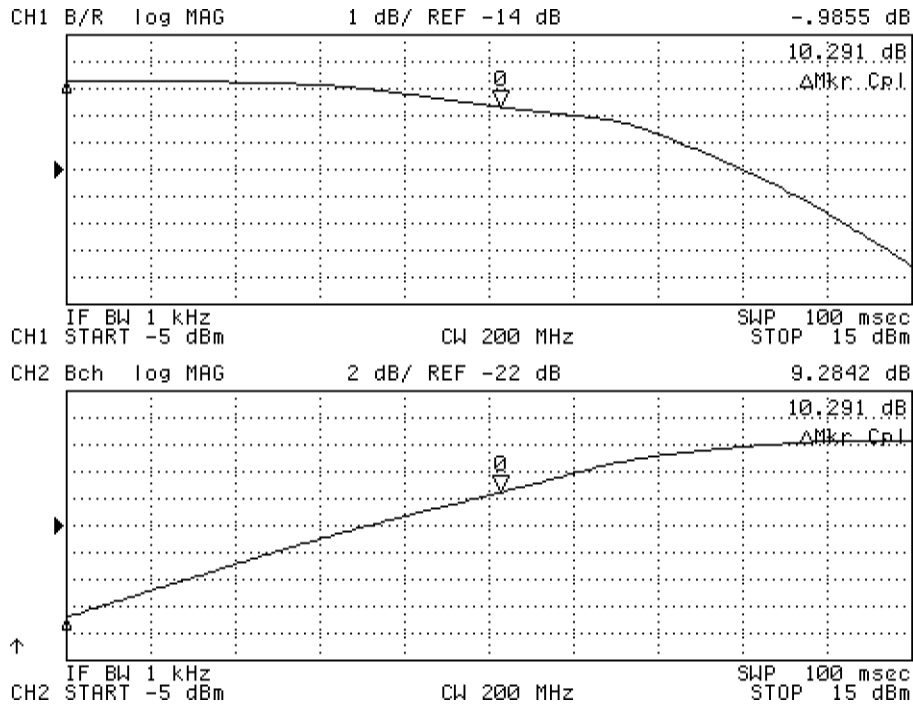

Figure 8-11. Gain Compression Measurement

```

10 !
20 !Fig.8-12 Gain Compression Measurement
30 !
40 ASSIGN @Hp4395 TO 717 ! When iBASIC is used, change "717" to "800"
50 !
60 Targ=-1 ! Gain compressoion target value [dB]
70 !
80 OUTPUT @Hp4395;"PRES"
90 OUTPUT @Hp4395;"DISA HIHB"
100 GOSUB Setup
110 GOSUB Calibration
120 GOSUB Measurement
130 STOP
140 !
150 Setup:!
160 OUTPUT @Hp4395;"NA"
170 OUTPUT @Hp4395;"COUC ON"
180 OUTPUT @Hp4395;"CHAN1"
190 OUTPUT @Hp4395;"CWFREQ 200E6"
200 OUTPUT @Hp4395;"SWPT POWE"
210 OUTPUT @Hp4395;"STAR -5"
220 OUTPUT @Hp4395;"STOP 15"
230 OUTPUT @Hp4395;"FMT LOGM"
240 OUTPUT @Hp4395;"BW 10E3"
250 OUTPUT @Hp4395;"MEAS BR"
260 !

```

Figure 8-12. Sample Program : Gain Compression Measurement (1/2)

```

270 OUTPUT @Hp4395;"CHAN2"
280 OUTPUT @Hp4395;"MEAS B"
290 OUTPUT @Hp4395;"MKR ON"
300 OUTPUT @Hp4395;"CHAN1"
310 OUTPUT @Hp4395;"MKR ON"
320 OUTPUT @Hp4395;"DUAC ON"
330 OUTPUT @Hp4395;"COUC ON"
340 OUTPUT @Hp4395;"MKRCOUP ON"
350 OUTPUT @Hp4395;"*OPC?"
360 ENTER @Hp4395;Dummy
370 RETURN
380 !
390 Calibration: !
400 CLEAR SCREEN
410 BEEP
420 PRINT "Calibration"
430 OUTPUT @Hp4395;"CALI RESP"
440 DISP "Thru cal :press continue"
450 PAUSE
460 OUTPUT @Hp4395;"STANC"
470 OUTPUT @Hp4395;"*WAI"
480 OUTPUT @Hp4395;"RESPDOME" ! SAVE CAL DATA
490 OUTPUT @Hp4395;"*OPC?"
500 ENTER @Hp4395;Dummy
510 RETURN
520 !
540 Measurement: !
550 CLEAR SCREEN
560 BEEP
570 DISP "CONNECT DEVICE and press continue"
580 PAUSE
590 FOR I=2 TO 1 STEP -1
600 OUTPUT @Hp4395;"CHAN";CHR$(48+I)
610 OUTPUT @Hp4395;"SING"
620 OUTPUT @Hp4395;"*WAI"
630 OUTPUT @Hp4395;"AUTO"
640 NEXT I
650 !
660 OUTPUT @Hp4395;"SEAM MAX"
670 OUTPUT @Hp4395;"DMKR ON"
680 OUTPUT @Hp4395;"SEATARG ";Targ
690 OUTPUT @Hp4395;"MKRPRM?"
700 ENTER @Hp4395;Pow1
710 OUTPUT @Hp4395;"ANAOCH2"
720 OUTPUT @Hp4395;"MKRVAL?"
730 ENTER @Hp4395;Ampval
740 OUTPUT @Hp4395;"ANAOCH1"
750 OUTPUT @Hp4395;"DUAC ON"
760 PRINT ""
770 PRINT Targ;"dB Gain Compression ";Pow1;"dBm"
780 PRINT "Absolute Output Power";Ampval;"dB"
790 DISP "END"
800 RETURN
810 !
820 END

```

Sample Program : Gain Compression Measurement (2/2)

Lines 150 to 370 specify basic measurement settings.

Line 400 to 510 perform calibration. The program performs only THRU calibration to simplify the procedure.

Lines 590 to 640 perform sweep. Lines 660 and after move the marker to read the parameters at the point it is located. This program uses `ANAOCH` command to switch the channel from which data is retrieved. Refer to the `ANAOCH` entry in the command reference in this manual.

Programs for the Spectrum Analyzer Mode

This section provides sample programs for your convenience when calculating some spectrum analysis factors.

To Obtain Total Harmonic Distortion (THD)

Most transmitting devices and signal sources contain harmonics as shown in Figure 8-13.

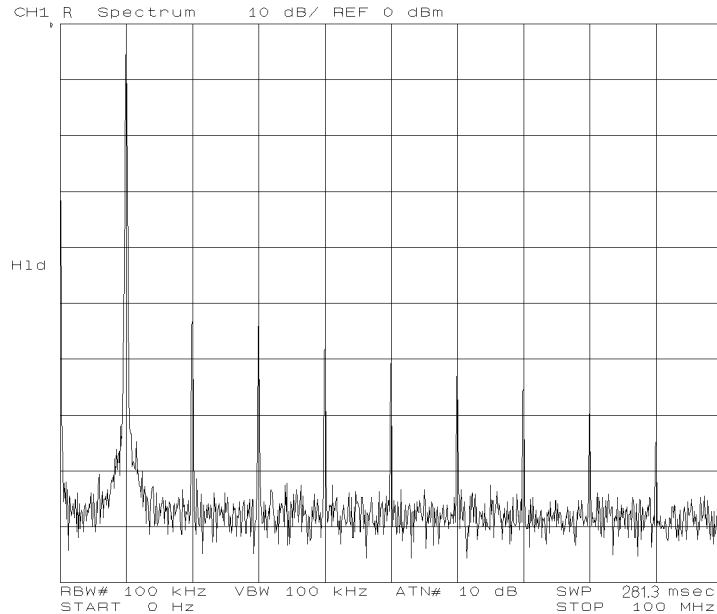

Figure 8-13. Total Harmonic Distortion in a Signal

This program computes the total harmonic distortion (THD) as defined by the following equation:

$$THD = \frac{\sqrt{V_2^2 + V_3^2 + \dots}}{V_1} \times 100 [\%] \quad (8 - 1)$$

Where,

- V_1 Fundamental [V]
- V_2 The second harmonic [V]
- V_3 The third harmonic [V]
- \vdots

THD takes into account the power in all the harmonics. Because an infinite number of the harmonics cannot be measured, a finite number will have to suffice.

Before running the program, measure the signal and display the fundamental and harmonics to be computed on the analyzer display (in the dBm format).

```

10  !
20  !Fig.8-14 Total Harmonic Distortion
30  !
40    Vf=1
50    ASSIGM @Hp4395 TD 717 ! When iBASIC is used, replace "717" to "800"
60    OUTPUT @Hp4395;"CLES;*SRE 4;ESNB 96"
70    ON INTR 7 GOTO Done ! \ When iBASIC is used,
80    ENABLE INTR 7;2      ! / replace "7" to "8"
90    OUTPUT @Hp4395;"STOP?"
100   ENTER @Hp4395;Fstop
110   OUTPUT @Hp4395;"PRSMKRS"
120   OUTPUT @Hp4395;"MKR ON;SEAM PEAK"
130   OUTPUT @Hp4395;"OUTPMKR?"
140   ENTER @Hp4395;Vf,Vf2,Ff ! Fundamental
150   Vf=SQR(10^(Vf/10)*.05) ! Vf in V
160   PRINT "Fundamental"
170   Fr=Ff
180   I=2
190   S=0
200   LOOP
210     Fh=Ff*I
220     EXIT IF Fstop<=Fh
230     OUTPUT @Hp4395;"DMKR TRAC;MKRPRM ";Fh-Fr/2
240     OUTPUT @Hp4395;"DMKR ON"
250     OUTPUT @Hp4395;"MKRPRM ";Fr
260     OUTPUT @Hp4395;"PARS ON;SEARSTR"
270     OUTPUT @Hp4395;"SEAM PEAK;DMKR OFF"
280     OUTPUT @Hp4395;"OUTPMKR?"
290     ENTER @Hp4395;Vh,Vh2,F
300     Vh=10^(Vh/10)*.05 ! Vh^2 in V^2
310     PRINT I;" harmonic"
320     S=S+Vh
330     I=I+1
340   END LOOP
350  !
360 Done:  !
370   Thd=SQR(S)/Vf*100
380   PRINT "THD=";Thd;" %"
390   DISP "PROGRAM FINISHED"
400   END

```

Figure 8-14. Sample Program : Total Harmonic Distortion (THD)

In line 120 the marker searches for the fundamental frequency.

In lines 200 to 340 the marker searches for the harmonics on the analyzer display and integrates the squares.

Line 370 calculates the THD and line 380 prints the result.

To Obtain an Integral of a Power

This section provides the sample program which calculates the integral of the power within a specified frequency range. In this program, the frequency range is specified with a center (carrier) frequency and span. Before running this program, measure the frequency characteristic of a signal to obtain the frequency range over which you want to integrate. Then specify the range in the program.

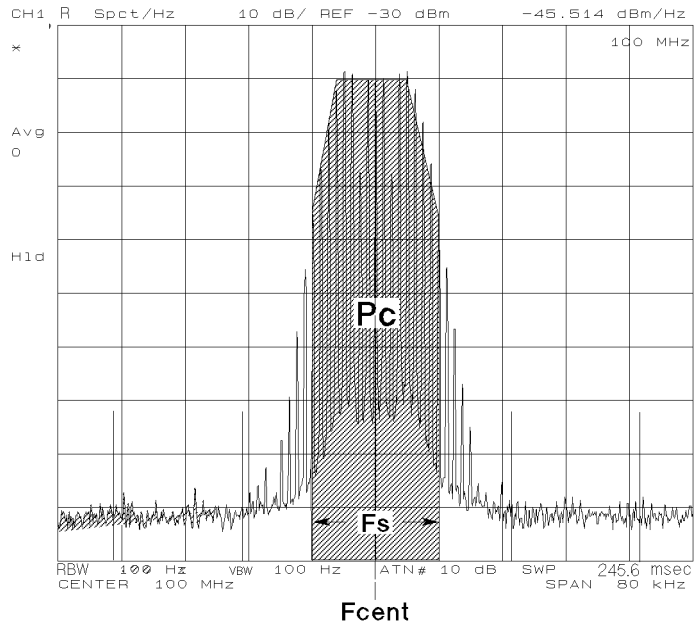

integral.gal

Figure 8-15. Integral Calculation of a Power

```

10 !
20 !Fig.8-16 Power Integral Calculation
30 !
40 ASSIGN @Hp4395 TO 717 ! When iBASIC is used, change "717" to "800"
50 Fs=16000 ! Target band width, Hz
60 Rbw=100 ! Resolution band width, Hz
70 Fspan=80000 ! Frequency Span, Hz
80 Avg=10 ! Averaging factor
90 !
100 CLEAR SCREEN
110 INPUT "Enter carrier frequency(Hz).",Fcent
120 OUTPUT @Hp4395;"CENT ";Fcent
130 OUTPUT @Hp4395;"SPAN ";Fspan
140 OUTPUT @Hp4395;"BW ";Rbw
150 OUTPUT @Hp4395;"AVERFACT ";Avg
160 OUTPUT @Hp4395;"FMT NOISE;SAUNIT DBM;ATTAUTO ON;AVER ON"
170 OUTPUT @Hp4395;"HOLD;AVERREST"
180 !
190 INPUT "Connect input port and press Enter.",Dum$
200 DISP "MEASURING"
210 OUTPUT @Hp4395;"TRGS INT"
220 OUTPUT @Hp4395;"CLES"
230 OUTPUT @Hp4395;"*SRE 4;ESMB 1"
240 ON INTR 7 GOTO Sweep_end ! \ When iBASIC is used,
250 ENABLE INTR 7;2 ! / change "7" to "8"
260 OUTPUT @Hp4395;"NUNG ";Avg
270 Measuring: GOTO Measuring

```

Figure 8-16. Sample Program : Integral Calculation of a Power (1/2)

```

280 Sweep_end:      !
290   DISP "MEASUREMENT COMPLETE"
300   DIM D(1:801)
310   OUTPUT @Hp4395;"FORM3"
320   ASSIGN @Dt TO 717;FORMAT OFF      ! When iBASIC is used,
330   OUTPUT @Hp4395;"OUTPDTRC?"      ! change "717" to "800"
340   ENTER @Dt USING "%,8A";Dum$
350   ENTER @Dt;D(*)
360   ENTER @Dt USING "%,1A";Dum$
370   !
380   Nop=801
390   OUTPUT @Hp4395;"POIN?"
400   ENTER @Hp4395;Nop
410   Pc=FNPower(D(*),Fspan,Fs,Nop,Fcent)
420   !
430   PRINT "Carrier (MHz):",Fcent/1.E+6
440   PRINT "Power (dBm):",Pc
450   PRINT
460   DISP "PROGRAM FINISHED"
470   END
480   !
490   DEF FNPower(D(*),Fspan,Fs,Nop,Fcent)
500     Fdelta=Fspan/(Nop-1)
510     Ich0=401
520     Ich=PROUND(Ich0,0)
530     I1=Ich-PROUND(Fs/2/Fdelta,0)
540     I2=Ich+PROUND(Fs/2/Fdelta,0)
550     IF I1<1 OR I2>Nop THEN
560       P=0
570       BEEP
580       PRINT "====="
590       PRINT "Frequency Range is Invalid!"
600       PRINT "====="
610       RETURN P
620     END IF
630     S=0
640     FOR I=I1 TO I2
650       S=S+10^(D(I)/10)      ! Change to Linear
660     NEXT I
670     P=S*Fdelta
680     P=10*LGT(P)           ! Change to log
690     RETURN P
700   FNEND

```

Sample Program : Integral Calculation of a Power (2/2)

Lines 50 to 80 specify typical values to the measurement factor (Fs), frequency span, resolution bandwidth, and averaging factor.

Lines 490 to 700 are the subprogram FNPower which accumulates a power at each measurement point within the range specified with the center frequency Fch and the frequency span Fs. The total power is obtained by the following equations:

$$PWR = 10 \log_{10} P_1 \text{ [dBm]} \quad (8-2-a)$$

$$P_1 = \sum_{x=I1}^{x=I2} \frac{D1(x)Fspan}{Nop} \text{ [mW]} \quad (8-2-b)$$

$$D1(x) = 10^{(D(x)/10)} \times 0.05 \text{ [mW/Hz]} \quad (8-2-c)$$

Where,

$D(x)$	Power density spectrum at each measurement point [dBm/Hz]
F_{span}	Measurement frequency span [Hz]
N_{op}	Number of measurement points
I1, I2	Measurement points at the left/right end of channel bandwidth (F_s)

When calculating a total power, each measurement value should be converted from logarithmic (dBm) to linear [mW]. They should then be added together and re-converted into decibels [dBm], as shown in the equations (8-2). This program simplifies this procedure by converting values to linear, shown in the line 650 (note that it is not converted to [mW] unit), then re-converting into [dBm] shown in the line 680.

To Obtain Adjacent Channel Power

The adjacent channel power measurement examines the leakage power transmitted into an adjacent channel (that is, the channel next to the carrier channel). This program calculates the ratio of the adjacent channel power leakage to the power of the transmitter ($P_l - P_c$, $P_h - P_c$) in dBc.

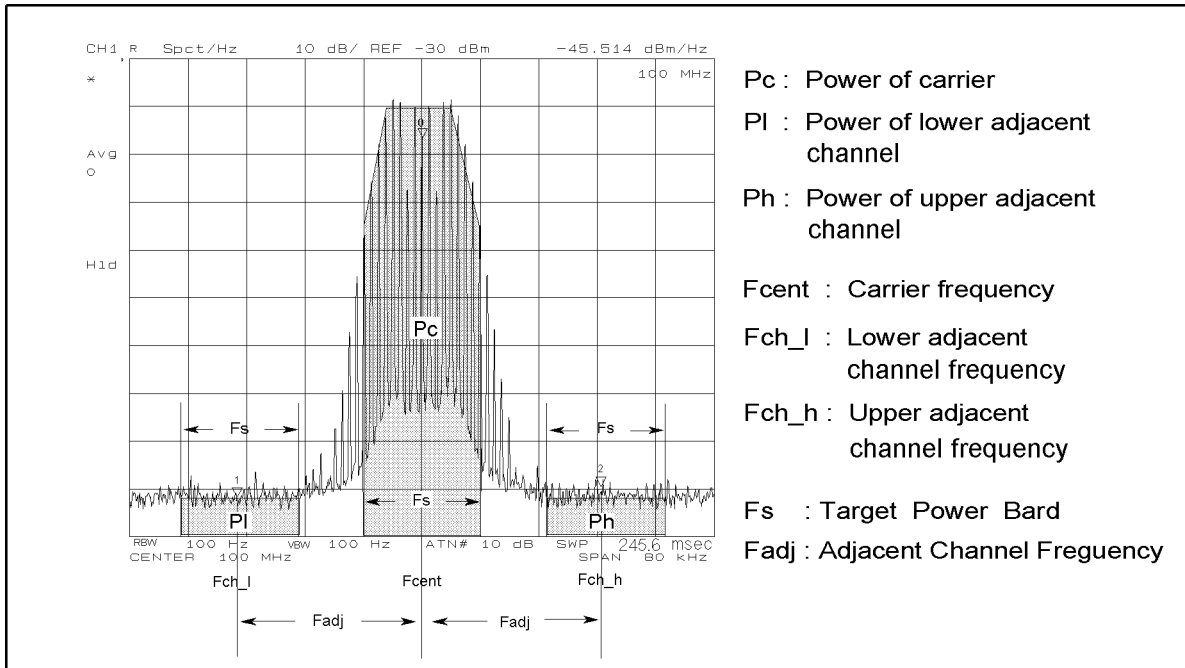

Figure 8-17. Adjacent Channel Power

Before running the program, set up the measurement and connect the signal to the input port.

```

10 !
20 !Fig.8-18 Adjacent Channel Power Calculation
30 !
40 ASSIGN @Hp4395 TO 717 ! When iBASIC is used, change "717" to "800"
50 Fadj=25000 ! Channel spacing, Hz
60 Fs=16000 ! Target band width, Hz
70 Rbw=100 ! Resolution band width, Hz
80 Nop=801 ! Number of measurement points
90 Fspan=80000 ! Frequency Span, Hz
100 Avg=10 ! Averaging factor
110 !
120 CLEAR SCREEN
130 INPUT "Enter carrier frequency(Hz).",Fcent
140 OUTPUT @Hp4395;"CENT ";Fcent
150 OUTPUT @Hp4395;"SPAN ";Fspan
160 OUTPUT @Hp4395;"BW ";Rbw
170 OUTPUT @Hp4395;"AVERFACT ";Avg
180 OUTPUT @Hp4395;"FMT NOISE;SAUNIT DBM;ATTAUTO ON;AVER ON"
190 OUTPUT @Hp4395;"HOLD;AVERREST"
200 !
210 INPUT "Connect input port and press Enter.",Dum$
220 DISP "MEASURING"
230 OUTPUT @Hp4395;"TRGS INT"
240 OUTPUT @Hp4395;"CLES"
250 OUTPUT @Hp4395;"*SRE 4;ESNB 1"
260 ON INTR 7 GOTO Sweep_end ! \ When iBASIC is used,
270 ENABLE INTR 7;2 ! / change "7" to "8"
280 OUTPUT @Hp4395;"NUNG ";Avg
290 Measuring:GOTO Measuring
300 Sweep_end: !
310 DISP "MEASUREMENT COMPLETE"
320 DIM D(1:801)
330 OUTPUT @Hp4395;"FORM3"
340 ASSIGN @Dt TO 717;FORMAT OFF ! When iBASIC is used,
350 OUTPUT @Hp4395;"OUTPDTRC?" ! change "717" to "800"
360 ENTER @Dt USING "%,8A";Dum$
370 ENTER @Dt;D(*)
380 ENTER @Dt USING "%,1A";Dum$
390 !
400 Fch_l=Fcent-Fadj
410 Fch_h=Fcent+Fadj
420 Pc=FNPower(D(*),Fspan,Fcent,Fs,Nop,Fcent)
430 Pl=FNPower(D(*),Fspan,Fch_l,Fs,Nop,Fcent)
440 Ph=FNPower(D(*),Fspan,Fch_h,Fs,Nop,Fcent)
450 !
460 OUTPUT @Hp4395;"MKR ON;SMKR1 ON;SMKR2 ON"
470 OUTPUT @Hp4395;"MKRPRM ";Fcent
480 OUTPUT @Hp4395;"SMKRPRM1 ";Fch_l
490 OUTPUT @Hp4395;"SMKRPRM2 ";Fch_h
500 PRINT "Carrier (MHz):",Fcent/1.E+6
510 PRINT "Power (dBm):",Pc
520 PRINT
530 PRINT "Adjacent Channel Freq. Lo(Hz):",Fch_l
540 PRINT " Hi(Hz):",Fch_h
550 PRINT
560 PRINT "Adjacent Pow. Pl-Pc(dBc):",Pl-Pc
570 PRINT " Ph-Pc(dBc):",Ph-Pc
580 DISP "PROGRAM FINISHED"
590 END
600 !

```

Figure 8-18. Sample Program : Adjacent Channel Power Calculation (1/2)

```

610 DEF FNPowEr(D(*),Fspan,Fch,Fs,Nop,Fcent)
620   Fdelta=Fspan/(Nop-1)
630   Ich0=(Fch-Fcent)/Fdelta+401
631   Ich=PROUWD(Ich0,0)
640   I1=Ich-PROUWD(Fs/2/Fdelta,0)
650   I2=Ich+PROUWD(Fs/2/Fdelta,0)
660   IF I1<1 OR I2>Nop THEN
670     P=0
680     RETURN P
690   END IF
700   S=0
710   FOR I=I1 TO I2
720     S=S+10^(D(I)/10)
730   NEXT I
740   P=S*Fdelta
750   P=10*LGT(P)
760   RETURN P
770 FNEND

```

Sample Program : Adjacent Channel Power Calculation (2/2)

Lines 50 to 100 set the the following variables to typical values: measurement coefficient, Fadj, Fs, frequency span, resolution bandwidth, number of measurement points, and averaging factor.

Line 180 sets the display format to noise format.

In lines 610 to 760 (the subprogram **FNPowEr**) performs a summation of the power at the measurement points, in the area specified by the center frequency **Fch**, and the frequency span **Fs**. This program calculates based on the same equations as in “To Obtain an Integral of a Power” (See Equations (8-2)).

To Obtain Occupied Power Bandwidth

This program calculates the occupied power bandwidth of the carrier signal. It first computes the combined power of all the signal responses contained in the trace. It then calculates the point for which 0.5 % of the total power lies to the right of the right marker and to the left of the left marker. The frequency difference between these two points is the bandwidth.

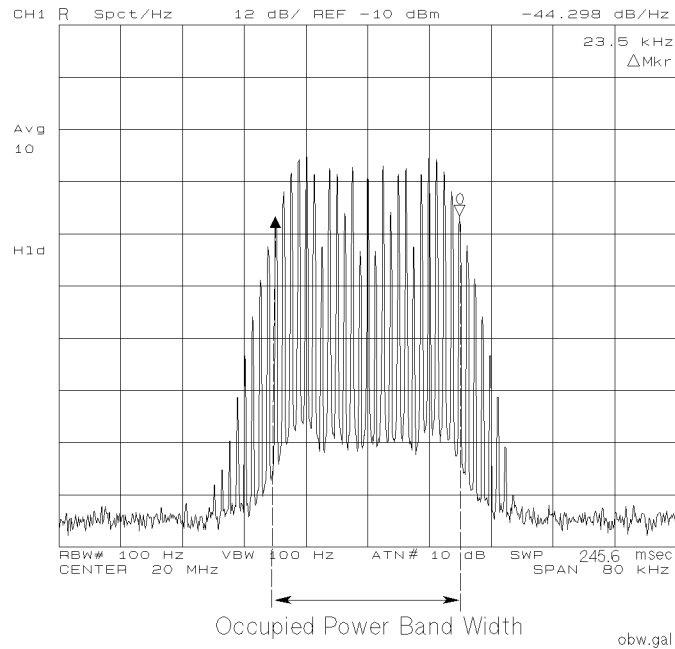

Figure 8-19. 99 % Occupied Power Bandwidth

Before running the program, set up the measurement and connect the signal to the input port.

```

10 !
20 !Fig.8-20 Occupied Power Band Width Calculation
30 !
40 ASSIGN @Hp4395 TO 717 ! When iBASIC is used, change "717" to "800"
50 Rbw=100 ! Resolution band width, Hz
60 Nop=801 ! Number of measurement points
70 Fspan=80000. ! Frequency Span, Hz
80 Avg=10 ! Averaging factor
90 !
100 INPUT "Enter carrier frequency(Hz).",Fcent
110 OUTPUT @Hp4395;"SPAN";Fspan
120 OUTPUT @Hp4395;"CENT";Fcent
130 OUTPUT @Hp4395;"BW";Rbw
140 OUTPUT @Hp4395;"FMT NOISE;DET POS"
150 OUTPUT @Hp4395;"SAUNIT DBM;ATTAUTO ON;AVER ON"
160 OUTPUT @Hp4395;"AVERFACT";Avg
170 !
180 INPUT "Connect input port and press Enter.",Dum$
190 OUTPUT @Hp4395;"HOLD"
200 OUTPUT @Hp4395;"CLES"
210 OUTPUT @Hp4395;"*SRE 4;ESNB 1"
220 ON INTR 7 GOTO Sweep_end ! \ When iBASIC is used,
230 ENABLE INTR 7;2 ! / change "7" to "8"
240 OUTPUT @Hp4395;"TRGS INT"
250 OUTPUT @Hp4395;"NUMG";Avg
260 Measuring:GOTO Measuring
270 Sweep_end: ! Get Data
280 DIM D(1:801)
290 DIM P(1:801)

```

Figure 8-20. Sample Program : Occupied Power Bandwidth Calculation (1/2)

```

300 OUTPUT @Hp4395;"FORM3"
310 ASSIGN @Dt TO 717;FORMAT OFF ! When iBASIC is used,
320 OUTPUT @Hp4395;"OUTPDTRC?" ! change "717" to "800"
330 ENTER @Dt USING "%,8A";Dum$
340 ENTER @Dt;D(*)
350 ENTER @Dt USING "%,1A";Dum$
360 !
370 Power(D(*),P(*),Rbw,Nop,Fspan)
380 !
390 FOR I=1 TO Nop
400 A=P(I)/P(Nop)
410 IF A>.005 THEN Lower
420 NEXT I
430 Lower:I1=I
440 FOR I=Nop TO 1 STEP -1
450 A=P(I)/P(Nop)
460 IF A<.995 THEN Upper
470 NEXT I
480 Upper:I2=I
490 OUTPUT @Hp4395;"MKR ON"
500 OUTPUT @Hp4395;"MKRP ";I1
510 OUTPUT @Hp4395;"DMKR ON"
520 OUTPUT @Hp4395;"MKRP ";I2
530 OUTPUT @Hp4395;"OUTPMKR?"
540 ENTER @Hp4395;Val,Val2,Flh
550 PRINT "Occupied band width :";
560 PRINT Flh;" Hz"
570 DISP "PROGRAM FINISHED"
580 END
590 !
600 SUB Power(D(*),P(*),Rbw,Nop,Fspan)
610 S=0
620 FOR I=1 TO Nop
630 S=S+10^(D(I)/10)
640 P(I)=S
650 NEXT I
660 SUBEND

```

Sample Program : Occupied Power Bandwidth Calculation (2/2)

Lines 40 to 80 set the following variables to typical values: measurement coefficient, frequency span, resolution bandwidth, number of measurement points, and averaging factor.

Lines 390 to 430 search from the left for the point where the power is 0.5 % compared to the total power. Lines 440 to 480 do the same search from the right.

Lines 490 to 540 display the marker and Δ marker on the 0.5 % power points and read out the spacing of the markers.

Lines 600 to 660 (subprogram **FNPower**) perform a summation of the power at the measurement points. This summation is done in the area specified by the center frequency (**Fch**) and the frequency span (**Fs**). The same equation (11-2) is used in the "To Obtain Adjacent Channel Power" example.

To Calculate an S/N Ratio

The sample program in this section calculates a signal-to-noise (S/N) ratio. This program measures the power of a signal component (a). It then calculates the power of a noise component (b) defined as the measurement data subtracted IF BW data above and below the measurement signal (b).

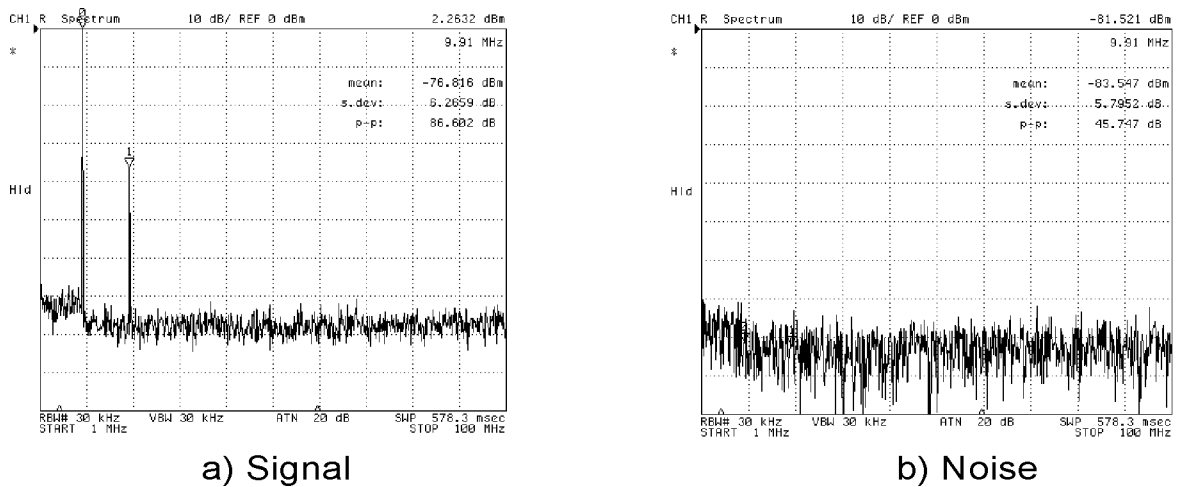

Figure 8-21. Calculating an S/N ratio

The measurement port should be setup before execution the program.

```

10 !Fig.8-22 Sample program to measure S/N ratio
20 !
30 DIM Dat(1:801)
40 !
50 Fstar=1.E+6 ! Start Frequency
60 Fstop=1.E+8 ! Stop Frequency
70 Rbw=30000. ! RBW
80 Rstar=5.E+6 ! Start of Noise BW
90 Rstop=6.E+7 ! Stop of Noise BW
100 !
110 ASSIGN @Hp4395 TO 717 ! When iBASIC is used, change "717" to "800"
120 ASSIGN @Dt TO 717;FORMAT OFF ! When iBASIC is used, change "717" to "800"
130 !
140 GOSUB Setup
150 GOSUB Measure_signal
160 GOSUB Measure_noise
170 GOSUB Printing
180 STOP
190 !
200 Setup: !
210 OUTPUT @Hp4395;"HOLD"
220 OUTPUT @Hp4395;"FORM3"
230 OUTPUT @Hp4395;"DISA HIHB"
240 PRINT "SNR Sample Program"
250 !

```

Figure 8-22. Sample Program : Calculating an S/N ratio (1/3)

```

260 OUTPUT @Hp4395;"STAR ";Fstar
270 OUTPUT @Hp4395;"STOP ";Fstop
280 OUTPUT @Hp4395;"BW ";Rbw
290 OUTPUT @Hp4395;"MKR ON;MKRUNIT DBM"
300 OUTPUT @Hp4395;"PARS ON;MEASTAT ON"
310 OUTPUT @Hp4395;"MKRPRM ";Rstar
320 OUTPUT @Hp4395;"SEARSTRL"
330 OUTPUT @Hp4395;"MKRPRM ";Rstop
340 OUTPUT @Hp4395;"SEARSTRR"
350 RETURN
360 !
370 Measure_signal:!
380 OUTPUT @Hp4395;"POIN?"
390 ENTER @Hp4395;Poin
400 Nrbw=INT(Rbw/((Fstop-Fstar)/(Poin-1)))+1
410 !
420 DISP "measuring signal power..."
430 OUTPUT @Hp4395;"FMT SPECT"
440 OUTPUT @Hp4395;"SING;*OPC?"
450 ENTER @Hp4395;Dummy
460 !
470 OUTPUT @Hp4395;"SEAM PKSA"
480 OUTPUT @Hp4395;"MKRVAL?"
490 ENTER @Hp4395;Psignal
500 OUTPUT @Hp4395;"MKRPRM?"
510 ENTER @Hp4395;Fsignal
520 OUTPUT @Hp4395;"MKR?"
530 ENTER @Hp4395;Mkr(0)
540 OUTPUT @Hp4395;"MKRP?"
550 ENTER @Hp4395;Mkrp(0)
560 FOR I=1 TO 7
570     OUTPUT @Hp4395;"SMKR"&VAL$(I)&"?"
580     ENTER @Hp4395;Mkr(I)
590     OUTPUT @Hp4395;"SMKRP"&VAL$(I)&"?"
600     ENTER @Hp4395;Mkrp(I)
610 NEXT I
620 OUTPUT @Hp4395;"DATMEM;DISP DATM"
630 RETURN
640 !
650 Measure_noise:!
660 DISP "measuring noise power..."
670 OUTPUT @Hp4395;"FMT NOISE"
680 OUTPUT @Hp4395;"SING;*OPC?"
690 ENTER @Hp4395;Dummy
700 !
710 OUTPUT @Hp4395;"OUTPDATA?"
720 ENTER @Hp4395 USING "8A,#";Head$
730 ENTER @Dt;Dat(*)
740 ENTER @Hp4395 USING "1A,#";Foot$
750 !
760 FOR I=0 TO 7
770     IF Mkr(I) THEN
780         FOR J=-Nrbw TO Nrbw
790             Dat(Mkrp(I)+J)=Dat(Mkrp(I)-Nrbw-1)
800         NEXT J
810     END IF
820 NEXT I
830 !
840 OUTPUT @Hp4395;"INPUDATA #46408";
850 OUTPUT @Dt;Dat(*),END
860 !

```

Sample Program : Calculating an S/N ratio (2/3)

```

870 OUTPUT @Hp4395;"MKRUNIT W"
880 OUTPUT @Hp4395;"OUTPMSTA?"
890 ENTER @Hp4395;Mean,Sdev,Pp
900 !
910 Pnoise=10*LGT(Mean*(Rstop-Rstar)*1000)
920 !
930 DISP "measuring done."
940 RETURN
950 !
960 Printing: !
970 PRINT
980 PRINT USING "K,MDDD.DDD,K,#";" Signal Power : ",Psignal,"dBm"
990 PRINT " @ ";FWEgr$(Fsignal,5);"Hz"
1000 PRINT USING "K,MDDD.DDD,K,#";" Noise Power : ",Pnoise,"dBm"
1010 PRINT " @ ";FWEgr$(Rstar,5);" to ";FWEgr$(Rstop,5);"Hz"
1020 PRINT USING "K,MDDD.DDD,K";" SNR : ",Psignal-Pnoise,"dB"
1030 !
1040 OUTPUT @Hp4395;"FMT SPECT"
1050 OUTPUT @Hp4395;"MKRUNIT DBM"
1060 RETURN
1070 !
1080 END
1090 !
1100 DEF FWEgr$(X,Round)
1110 Unit$="afpnum kMGTP"
1120 SELECT ABS(X)
1130 CASE >=1.E+18
1140 RETURN "*****"
1150 CASE <1.E-18
1160 RETURN "0"
1170 CASE ELSE
1180 Unit=INT(LGT(DROUND(ABS(X),Round))/3)
1190 RETURN VAL$(DROUND(X/10^(Unit*3),Round))&Unit$[Unit+7;1]
1200 END SELECT
1210 FNEED

```

Sample Program : Calculating an S/N ratio (3/3)

Lines 200 to 350 prepare for measurement.

Lines 370 to 630 measure signal.

Lines 470 to 550 use the marker function to search and measure the amplitude of and frequency of the signal where the marker is located.

Line 620 copies the measurement data of a signal from the data trace to the memory trace and displays both of the trace.

Lines 650 to 940 subtract the signal component from measurement data to the obtain noise component.

Line 670 set the display format to the noise format.

Lines 710 to 820 retrieve data, then subtract signal component.

Lines 1100 to 1210 are the subprogram which modifies the display format of the stop frequency.

Programs for the Impedance Analyzer Mode

To Perform Calibration

This section provides the sample program which performs calibration and compensation in the impedance analyzer mode. This program should run with 43961 impedance test kit and a test fixture appropriate for your DUT. See *Operation Manual* for detailed information on test fixtures.

```
10 !
20 !Fig.8-23 ZA Calibration
30 !
40 CLEAR SCREEM
50 ASSIGN @Hp4395 TO 717      ! When iBASIC is used, replace "717" to "800"
60 OUTPUT @Hp4395;"PRES"
70 OUTPUT @Hp4395;"ZA"
80 BEEP
90 DISP "Connect 43961A, THEN press continue"
100 PAUSE
110 !
120 Calibration:      !
130 OUTPUT @Hp4395;"CALK APC7"
140 OUTPUT @Hp4395;"BW 300;AVERFACT 8;AVER OM"
150 !
160 BEEP
170 PRINT "CALIBRATION"
180 DISP "OPEN CAL, READY? press continue"
190 PAUSE
200 OUTPUT @Hp4395;"CALI IMP"
210 OUTPUT @Hp4395;"CLASIMPA"
220 OUTPUT @Hp4395;"*OPC?"
230 ENTER @Hp4395;Dummy
240 DISP "SHORT CAL, READY? press continue"
250 PAUSE
260 OUTPUT @Hp4395;"CLASIMPB"
270 OUTPUT @Hp4395;"*OPC?"
280 ENTER @Hp4395;Dummy
290 DISP "LOAD CAL, READY? press continue"
300 PAUSE
310 OUTPUT @Hp4395;"CLASIMPC"
320 OUTPUT @Hp4395;"*WAI"
330 OUTPUT @Hp4395;"SAVIMP"
340 OUTPUT @Hp4395;"*OPC?"
350 ENTER @Hp4395;Dummy
360 !
370 DISP "Connect a fixture and press continue"
380 PAUSE
390 !
400 PRINT "SELECT FIXTURE"
410 PRINT "1 : 16191A"
420 PRINT "2 : 16192A"
430 PRINT "3 : 16193A"
440 PRINT "4 : 16194A"
450 !
460 INPUT " Input number of fixture",Fixt
470 !
480 SELECT Fixt
490 CASE 1
```

Figure 8-23. Sample Program : Calibration (1/2)

```

500     OUTPUT @Hp4395;"FIXT HP16191"
510     CASE 2
520     OUTPUT @Hp4395;"FIXT HP16192"
530     CASE 3
540     OUTPUT @Hp4395;"FIXT HP16193"
550     CASE 4
560     OUTPUT @Hp4395;"FIXT HP16194"
570     END SELECT
580     !
590     !
600     PRINT "COMPENSATION"
610     DISP "OPEN COMPEN. READY? press continue"
620     PAUSE
630     OUTPUT @Hp4395;"COMP;COMCA"
640     OUTPUT @Hp4395;"*OPC?"
650     ENTER @Hp4395;Dummy
660     DISP "SHORT COMPEN. READY? press continue"
670     PAUSE
680     OUTPUT @Hp4395;"COMCB"
690     OUTPUT @Hp4395;"*WAI"
700     OUTPUT @Hp4395;"SAVCOM"
710     OUTPUT @Hp4395;"*OPC?"
720     ENTER @Hp4395;Dummy
730     !
740     DISP "PROGRAM END"
750     END

```

Sample Program : Calibration (2/2)

In the impedance analyzer mode, calibration should be performed with the IF BW set to 300 Hz or less and the averaging factor greater than 7.

Line 200 starts the calibration. If execution comes to this line before the end of calibration, the program resets the calibration procedure.

Lines 210 to 350 perform calibration. Calibration should be done in synchronization with the controller. This program uses *OPC? for this purpose.

Lines 400 to 570 calculates the compensation for the test fixture you use, in terms of electrical length.

Lines 600 to 720 perform compensation.

To Measure Capacitance and the factor D

The sample program in this section measures capacitance and the factor D. The program also calibrates your 4395A.

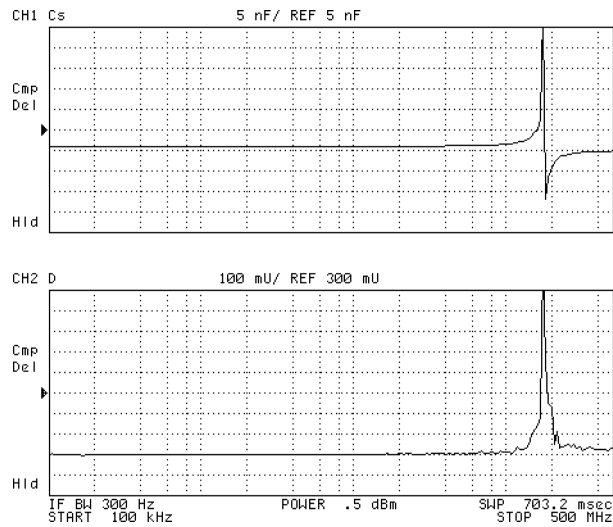

Figure 8-24. C-D Measurement

```

10 !
20 !Fig.8-25 PROGRAM TO MEASURE C-D
30 !
40 CLEAR SCREEN
50 ASSIGN @Hp4395 TO 717 ! When iBASIC is used replace "717" to "800"
60 OUTPUT @Hp4395;"PRES"
70 OUTPUT @Hp4395;"ZA"
80 OUTPUT @Hp4395;"*OPC?"
90 ENTER @Hp4395;Dummy
100 !
110 ! Interrupt Operation Set-up
120 OUTPUT @Hp4395;"CLES"
130 OUTPUT @Hp4395;"*SRE 32;*ESE 36"
140 ON INTR 7 GOSUB Err_report ! \ When iBASIC is used,
150 ENABLE INTR 7;2 ! / change "7" to "8"
160 !
170 BEEP
180 DISP "Connect 43961A, THEN press continue"
190 PAUSE
200 !
210 GOSUB Setup
220 GOSUB Calibration
230 GOSUB Measure
240 GOTO Ending
250 !
260 !
270 Setup:!
280 ! Measurement Setup
290 OUTPUT @Hp4395;"SWPT LOGF"
300 OUTPUT @Hp4395;"STAR 1E6"
310 OUTPUT @Hp4395;"STOP 500E6"
320 OUTPUT @Hp4395;"CHAN1"
330 OUTPUT @Hp4395;"MEAS CP"

```

Figure 8-25. Sample Program : C-D Measurement (1/4)

```

340 OUTPUT @Hp4395;"CHAN2"
350 OUTPUT @Hp4395;"MEAS D"
360 OUTPUT @Hp4395;"DUAC ON"
370 OUTPUT @Hp4395;"COUC ON"
380 OUTPUT @Hp4395;"MKRCOUP ON"
390 OUTPUT @Hp4395;"CHAN1"
400 OUTPUT @Hp4395;"*OPC?"
410 ENTER @Hp4395;Dummy
420 RETURN
430 !
440 Calibration:      !
450 BEEP
460 PRINT "CALIBRATION"
470 OUTPUT @Hp4395;"CALK APC7"
480 OUTPUT @Hp4395;"BW 300;AVERFACT 8;AVER OM"
490 DISP "OPEN CAL, READY? press continue"
500 PAUSE
510 OUTPUT @Hp4395;"CALI IMP"
520 OUTPUT @Hp4395;"CLASIMPA"
530 OUTPUT @Hp4395;"*OPC?"
540 ENTER @Hp4395;Dummy
550 DISP "SHORT CAL, READY? press continue"
560 PAUSE
570 OUTPUT @Hp4395;"CLASIMPB"
580 OUTPUT @Hp4395;"*OPC?"
590 ENTER @Hp4395;Dummy
600 DISP "LOAD CAL, READY? press continue"
610 PAUSE
620 OUTPUT @Hp4395;"CLASIMPC"
630 OUTPUT @Hp4395;"*WAI"
640 OUTPUT @Hp4395;"SAVIMP"
650 OUTPUT @Hp4395;"*OPC?"
660 ENTER @Hp4395;Dummy
670 !
671 OUTPUT @Hp4395;"USKEY"
680 DISP "Connect a fixture, then press softkey"
690 ON KEY 1 LABEL "16191A" GOTO Fixt1
700 ON KEY 2 LABEL "16192A" GOTO Fixt2
710 ON KEY 3 LABEL "16193A" GOTO Fixt3
720 ON KEY 4 LABEL "16194A" GOTO Fixt4
730 ON KEY 5 LABEL "" GOTO 680
740 ON KEY 6 LABEL "" GOTO 680
750 ON KEY 7 LABEL "" GOTO 680
760 ON KEY 8 LABEL "ABORT" GOTO Fix_end
770 GOTO 770
780 !
790 Fixt1:!
800 OUTPUT @Hp4395;"FIXT HP16191"
810 GOTO Fix_end
820 Fixt2:!
830 OUTPUT @Hp4395;"FIXT HP16192"
840 GOTO Fix_end
850 Fixt3:!
860 OUTPUT @Hp4395;"FIXT HP16193"
870 GOTO Fix_end
880 Fixt4:!
890 OUTPUT @Hp4395;"FIXT HP16194"
900 GOTO Fix_end
910 Fix_end: !
920 OFF KEY

```

Sample Program : C-D Measurement (2/4)

```

930 !
940 DISP "OPEN COMPEN. READY? press continue"
950 PAUSE
960 OUTPUT @Hp4395;"COMP;COMCA"
970 OUTPUT @Hp4395;"*OPC?"
980 ENTER @Hp4395;Dummy
990 DISP "SHORT COMPEN. READY? press continue"
1000 PAUSE
1010 OUTPUT @Hp4395;"COMCB"
1020 OUTPUT @Hp4395;"*WAI"
1030 OUTPUT @Hp4395;"SAVCOM"
1040 OUTPUT @Hp4395;"*OPC?"
1050 ENTER @Hp4395;Dummy
1060 !
1070 RETURN
1080 !
1090 Measure: !
1100 DIM Res(5,2),Freq(5)
1110 DISP "Connect DUT, then press continue"
1120 PAUSE
1130 DISP "Measuring"
1140 !
1150 OUTPUT @Hp4395;"MKR ON"
1160 OUTPUT @Hp4395;"SMKR1 ON;SMKRPRM1 10E6"
1170 OUTPUT @Hp4395;"SMKR2 ON;SMKRPRM2 100E6"
1180 OUTPUT @Hp4395;"SMKR3 ON;SMKRPRM3 200E6"
1190 OUTPUT @Hp4395;"SMKR4 ON;SMKRPRM4 300E6"
1200 OUTPUT @Hp4395;"SMKR5 ON;SMKRPRM5 500E6"
1210 OUTPUT @Hp4395;"MKRPRM 1E6"
1220 !
1230 FOR I=1 TO 2
1240 OUTPUT @Hp4395;"CHAN";CHR$(I+48)
1250 OUTPUT @Hp4395;"*WAI"
1260 OUTPUT @Hp4395;"SING"
1270 OUTPUT @Hp4395;"*WAI"
1280 OUTPUT @Hp4395;"AUTO"
1290 OUTPUT @Hp4395;"MKRVAL?"
1300 ENTER @Hp4395;Res(0,I)
1310 OUTPUT @Hp4395;"MKRPRM?"
1320 ENTER @Hp4395;Freq(0)
1330 FOR J=1 TO 5
1340 OUTPUT @Hp4395;"SMKRVAL";CHR$(J+48);"? "
1350 ENTER @Hp4395;Res(J,I)
1360 OUTPUT @Hp4395;"SMKRPRM";CHR$(J+48);"? "
1370 ENTER @Hp4395;Freq(J)
1380 NEXT J
1390 NEXT I
1400 !
1410 !PRINTING
1420 PRINT ""
1430 PRINT "RESULTS"
1440 PRINT "Freq.          Capacitance(F)          D"
1450 PRINT "===== "
1460 FOR I=0 TO 5
1470 PRINT Freq(I),"MHz",Res(I,1),Res(I,2)
1480 NEXT I
1490 DISP "Measurement complete"
1500 !
1510 RETURN
1520 !
1530 Err_report: !

```

Sample Program : C-D Measurement (3/4)

```

1540 OUTPUT @Hp4395;"OUTPERR0"
1550 ENTER @Hp4395;Err,Err$
1560 BEEP
1570 PRINT "ERROR DETECTED!"
1580 PRINT Err,Err$
1590 !
1600 A=SPOLL(@Hp4395)
1610 OUTPUT @Hp4395;"*ESR?"
1620 ENTER @Hp4395;Estat
1630 ENABLE INTR 7          ! \ When iBASIC is used, change "7" to "8"
1640 RETURN
1650 !
1660 Ending: !
1670 DISP "Program Finish"
1680 END

```

Sample Program : C-D Measurement (4/4)

Lines 440 to 1070 perform calibration in the same way as in “To Perform Calibration”, except electric length compensation which uses the ON KEY LABEL function.

Lines 1290 to 1370 show that data is read with the marker. Use the OUTPDTRC? command to retrieve all the measurement data.

Lines 1530 to 1630 set interruption to be generated when an GPIB error occurs. See Chapter 5 for information on interruption processing in detail.

To Measure a Varactor Diode Using DC Bias Sweep (With Option 010)

In the 4395A, the list sweep function is required in order to measure DUT characteristics as a function of DC bias voltage. The sample program in this section sweeps DC bias voltage across 15 measurement points with fixed frequencies.

A varactor diode is a device whose barrier capacitance varies depending on inverse bias voltage. It is used in many kinds of circuits including a VCO (Voltage Control Oscillator).

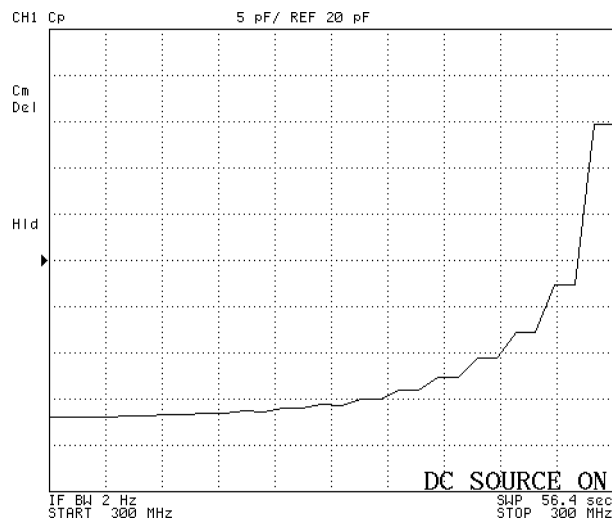

Figure 8-26. Characteristic of a Varactor Diode

```

10 !
20 !Fig.8-27 Varactor Diode MEASUREMENT
30 !
40 ASSIGN @Hp4395 TO 717 ! When iBASIC is used, change "717" to "800"
50 !
60 GOSUB Setup
70 GOSUB Setlist
80 GOSUB Calibration
90 GOSUB Measurement
100 !
110 Setup: !
120 OUTPUT @Hp4395;"PRES"
130 OUTPUT @Hp4395;"ZA"
140 OUTPUT @Hp4395;"CHAN1"
150 OUTPUT @Hp4395;"MEAS CP"
160 OUTPUT @Hp4395;"DCCTL VOLT"
170 RETURN
180 !
190 Setlist: !
200 DIM Voltfact(15)
210 OUTPUT @Hp4395;"AVER OFF"
220 OUTPUT @Hp4395;"LISDOBASE"
230 Freq=3.E+8
240 INPUT "Enter frequency(Hz)",Freq
250 Dcvmin=-30
260 INPUT "ENTER DC sweep level : Lower(V)",Dcvmin
270 Dcvmax=-.1
280 INPUT "ENTER DC sweep level : Upper(V)",Dcvmax
290 Pow=-13
300 INPUT "Enter power level(dBm)",Pow
310 Ifbw=2
320 INPUT "ENTER IFBW (Hz)",Ifbw
330 Curr=100
340 INPUT "ENTER DC bias current limit(mA)",Curr
350 Curr=Curr/1000
360 OUTPUT @Hp4395;"MAXDCI";Curr
370 !
380 Dcstep=(Dcvmax-Dcvmin)/14
390 !
400 OUTPUT @Hp4395;"CLEL"
410 OUTPUT @Hp4395;"EDITLIST"
420 FOR I=1 TO 15
430 Voltfact(I)=Dcvmin+Dcstep*(I-1)
440 NEXT I
450 FOR I=1 TO 15
460 OUTPUT @Hp4395;"SADD"
470 OUTPUT @Hp4395;"STAR ";Freq
480 OUTPUT @Hp4395;"STOP ";Freq
490 OUTPUT @Hp4395;"POIN 2"
500 OUTPUT @Hp4395;"POWE ";Pow
510 OUTPUT @Hp4395;"DCV ";Voltfact(I)
520 OUTPUT @Hp4395;"BW ";Ifbw
530 OUTPUT @Hp4395;"SDON"
540 NEXT I
550 OUTPUT @Hp4395;"EDITDONE"
560 OUTPUT @Hp4395;"*OPC?"
570 ENTER @Hp4395;Dummy
580 OUTPUT @Hp4395;"SWPT LIST"
590 !
600 RETURN
610 !

```

Figure 8-27. Sample Program : Measuring Varactor Diode Characteristic (1/3)

```

620 Calibration:      !
630   BEEP
640   OUTPUT @Hp4395;"AVERFACT 8;AVER ON"
650   PRINT "CALIBRATION"
660   DISP "OPEN CAL, READY? press continue"
670   PAUSE
680   OUTPUT @Hp4395;"CALI IMP"
690   OUTPUT @Hp4395;"CLASIMPA"
700   OUTPUT @Hp4395;"*OPC?"
710   ENTER @Hp4395;Dummy
720   DISP "SHORT CAL, READY? press continue"
730   PAUSE
740   OUTPUT @Hp4395;"CLASIMPB"
750   OUTPUT @Hp4395;"*OPC?"
760   ENTER @Hp4395;Dummy
770   DISP "LOAD CAL, READY? press continue"
780   PAUSE
790   OUTPUT @Hp4395;"CLASIMPC"
800   OUTPUT @Hp4395;"*WAI"
810   OUTPUT @Hp4395;"SAVIMP"
820   OUTPUT @Hp4395;"*OPC?"
830   ENTER @Hp4395;Dummy
840   !
850   OUTPUT @Hp4395;"KEY 47"
860   OUTPUT @Hp4395;"KEY 0"
870   OUTPUT @Hp4395;"KEY 6"
880   DISP "Connect a fixture, then press soft key"
890   ON KEY 1 LABEL "16191A" GOTO Fixt1
900   ON KEY 2 LABEL "16192A" GOTO Fixt2
910   ON KEY 3 LABEL "16193A" GOTO Fixt3
920   ON KEY 4 LABEL "16194A" GOTO Fixt4
930   ON KEY 5 LABEL "" GOTO 880
940   ON KEY 6 LABEL "" GOTO 880
950   ON KEY 7 LABEL "" GOTO 880
960   ON KEY 8 LABEL "ABORT" GOTO Fix_end
970   GOTO 970
980   !
990   Fixt1: !
1000   OUTPUT @Hp4395;"FIXT HP16191"
1010   GOTO Fix_end
1020   Fixt2: !
1030   OUTPUT @Hp4395;"FIXT HP16192"
1040   GOTO Fix_end
1050   Fixt3: !
1060   OUTPUT @Hp4395;"FIXT HP16193"
1070   GOTO Fix_end
1080   Fixt4: !
1090   OUTPUT @Hp4395;"FIXT HP16194"
1100   GOTO Fix_end
1110   Fix_end: !
1120   OFF KEY
1130   !
1140   BEEP
1150   DISP "OPEN COMPEN. READY? press continue"
1160   PAUSE
1170   OUTPUT @Hp4395;"COMP;COMCA"
1180   OUTPUT @Hp4395;"*OPC?"
1190   ENTER @Hp4395;Dummy
1200   DISP "SHORT COMPEN. READY? press continue"
1210   PAUSE
1220   OUTPUT @Hp4395;"COMCB"

```

Sample Program : Measuring Varactor Diode Characteristic (2/3)

```

1230 OUTPUT @Hp4395;"*WAI"
1240 OUTPUT @Hp4395;"SAVCOM"
1250 OUTPUT @Hp4395;"*OPC?"
1260 ENTER @Hp4395;Dummy
1270 !
1280 RETURN
1290 !
1300 Measurement:!
1310 INPUT "Connect DUT, and press Enter.",Dum$
1320 OUTPUT @Hp4395;"DCO ON"
1330 OUTPUT @Hp4395;"CLES"
1340 OUTPUT @Hp4395;"*SRE 4;ESNB 1"
1350 ON INTR 7 GOTO Sweep_end ! \ When iBASIC is used, change "7" to "8"
1360 ENABLE INTR 7;2 ! /
1370 OUTPUT @Hp4395;"SING"
1380 Measuring: GOTO Measuring
1390 !
1400 Sweep_end: !
1410 DIM Dat(1:30,1:2)
1420 OUTPUT @Hp4395;"AUTO"
1430 OUTPUT @Hp4395;"OUTPDTRC?"
1440 ENTER @Hp4395;Dat(*)
1450 PRINT ""
1460 PRINT " Measurement Result"
1470 PRINT " Measurement Frequency      :";Freq;"Hz"
1480 PRINT " Measurement Power             :";Pow;"dB"
1490 PRINT " "
1500 PRINT " No.          DC(V)          Cp(F)"
1510 PRINT "===== "
1520 FOR I=1 TO 15
1530 PRINT I,DcVmin+Dcstep*(I-1),Dat(I*2-1,1)
1540 NEXT I
1550 !
1560 END

```

Sample Program : Measuring Varactor Diode Characteristic (3/3)

Lines 450 to 570 input segments of a list sweep to 4395A.

Calibration, lines 620 to 1260, should be performed after to have inputted segments of a list sweep.

Lines 500 to 570 perform a sweep measurement. This program uses the status reporting system to work in synchronization with the end of sweep.

File Transfer Function

This section describes how to use the file transfer function, showing you a sample program.

The file transfer function uses the external controller to transfer files between the selected storage device of this instrument (memory disk or diskette) and an external storage device (such as hard disk). This function allows you to:

- Directly access data you want to use on the external controller.

For example, you can transfer the files saved on the 4395A storage device, such as graphic files or data array (ASCII format) files, to the external controller. Then, you can output the graphic file transferred from a printer connected to the external controller, or manage the data array (ASCII format) transferred using a software running on the external controller.

- Use external storage devices, which have larger capacity compared to the memory disk or a diskette.

For example, if there are a great number of measurement conditions which require calibration, the amount of the setting data becomes extremely large, including calibration data. In this case, it is impractical to store all of these settings on the memory disk or a single diskette at a time. However, you can realize this functionality by transferring them to the external controller and then storing them on an external storage device.

- Perform remote measurement using the external controller with a few GPIB commands for basic measurement. You do not have to memorize further details (such as GPIB commands used for detailed settings).

Preparation:

Use the keys on the front panel to establish the setting required for your measurement. Store it on the storage device of the 4395A, then transfer the file to the external controller, and store it on an external storage device. Repeat this procedure for all of the settings required for your measurement.

Measurement:

Choose a necessary setting file from those stored and transfer it to the 4395A using the external controller. Then, recall the file to set the 4395A for the measurement and perform the measurement using the GPIB commands.

The storage device of the 4395A allows you to handle files listed below in the DOS format or the LIF format. For DOS format files, both binary files and ASCII files can be transferred. For LIF format files, only binary files can be transferred.

- Binary files
 - Instrument settings and internal data array (STATE)
 - Internal data arrays (DATA ONLY binary)
 - Graphic images (GRAPHICS)
- ASCII files
 - Internal data arrays (DATA ONLY ascii)
 - HP instrument BASIC programs

File Transfer from 4395A to External Controller

This program transfers a specified file in the current directory (memory disk in the sample program of Figure 8-28) of the 4395A to the current directory of the storage device (A drive in the sample program of Figure 8-28) connected to the external controller, giving a file name you desire.

When executed, this program first prompts you to enter a source file name, as shown below. Enter the name of a file you want to transfer. Note that the file name of the LIF format can be distinguished between capital and small letters.

```
ENTER SOURCE FILE NAME ON INSTRUMENT ?
```

Then, the program prompts you to enter a destination file name as shown below, and in this example, SAMPLE.STA (DOS format) or SAMPLE_S (LIF format) has been entered as the source file name. Enter the file name you want to give on the storage device. Note that a file with the same name will be overwritten, if it already exists.

```
ENTER SOURCE FILE NAME ON INSTRUMENT ?      SAMPLE.STA (SAMPLE_S)
ENTER DESTINATION FILE NAME ON CONTROLLER ?
```

```
10  !
11  ! Fig.8-28 File transfer (Instrument -> Controller)
12  !
13  !
14  DIM Src_file$[50],Dst_file$[50]
15  ASSIGN @Agt4395 TO 717
16  OUTPUT @Agt4395;"*rst"
17  !
18  MASS STORAGE IS "a:\"
19  OUTPUT @Agt4395;"STODMEMO"
20  !
21  PRINT " ENTER SOURCE FILE NAME ON INSTRUMENT ? ";
22  INPUT Src_file$
23  PRINT Src_file$
24  !
25  PRINT " ENTER DESTINATION FILE NAME ON CONTROLLER ? ";
26  INPUT Dst_file$
27  PRINT Dst_file$
28  !
29  Copy_from_instr(@Agt4395,Src_file$,Dst_file$)
30  !
31  END
32  !
33  ! copy_from_instrument
34  !
35  SUB Copy_from_instr(@Agt4395,Src_file$,Dst_file$)
36  DIM Len$[6],Img$[32],Dmy$[2]
37  !
38  ON ERROR GOTO Skip_purge
39  PURGE Dst_file$
40  Skip_purge: OFF ERROR
41  CREATE Dst_file$,1
42  ASSIGN @Dst_file TO Dst_file$
43  !
44  CLEAR @Agt4395
45  OUTPUT @Agt4395;"CLES"
46  OUTPUT @Agt4395;"ROPEN """,Src_file$,"""""
47  IF FNCheck_error(@Agt4395,"<CPFI: ropen>")=-1 THEN SUBEXIT
```

Figure 8-28. Sample Program: File Transfer from 4395A to External Controller (1/2)

```

380      !
390      LOOP
400          OUTPUT @Agt4395;"READ?"
410          ENTER @Agt4395 USING "#,2A";Dmy$
420          ENTER @Agt4395 USING "#,6A";Len$
430          Block_size=VAL(Len$)
440          !
450          IF Block_size=0 THEN
460              ENTER @Agt4395 USING "%,A";Dmy$
470              ASSIGN @Dst_file TO *
480              OUTPUT @Agt4395;"CLOSE"
490              SUBEXIT
500          END IF
510          !
520          ALLOCATE Dat$(Block_size)
530          Img$="#,&VAL$(Block_size)&"A"
540          ENTER @Agt4395 USING Img$;Dat$
550          ENTER @Agt4395 USING "%,A";Dmy$
560          OUTPUT @Dst_file USING Img$;Dat$
570          DEALLOCATE Dat$
580          !
590          IF FNCheck_error(@Agt4395,"<CPFI: block read>")=-1 THEN SUBEXIT
600      END LOOP
610  SUBEND
620  !
630  ! Instrument Error Check
640  !
650  DEF FNCheck_error(@Agt4395,Str$)
660      DIM Err$(64)
670      OUTPUT @Agt4395;"OUTPERRO?"
680      ENTER @Agt4395;Err$
690      IF Err$<>"0","No error" THEN
700          PRINT "ERROR: ";Str$;" ";Err$
710          RETURN -1
720      ELSE
730          RETURN 0
740      END IF
750  FNEND

```

Sample Program: File Transfer from 4395A to External Controller (2/2)

Lines 80 to 90 set the current directory of the external controller to A drive and sets the current directory of the 4395A to the memory disk. You can set the current directory of the 4395A to the internal flexible disk using the **STODDISK** command. The A drive in the external controller may not be detected under a certain environment of the external controller, so change the drive depending on the situation.

Lines 110 to 170 accept the entry of the source file name and the destination file name.

Line 190 calls the subprogram to transfer a file from the 4395A to the external controller.

Lines 280 to 320 prepare for writing to the destination file.

Lines 340 to 370 prepare for reading the source file to the external controller.

Line 400 executes the query command to read data.

Lines 410 to 430 read the part indicating the length of the fixed length block data (see Figure R-1) to obtain the length of the data to be transferred.

Lines 450 to 500 check the data length. If the data length is 0, the transfer process is terminated.

Depending on the data length obtained in lines 530 to 550, the program adjusts the format and reads the data part.

Line 560 writes the data to the destination file.

The maximum length of data transferred at a time is 16 Kbytes. Therefore, if the size of the

source file is greater than 16 Kbytes, the transfer routine, lines 400 to 590, is repeated until transferring all of the data is completed.

Lines 650 to 750 provide a function to check that no error has occurred in the 4395A.

File Transfer from External Controller to 4395A

This program transfers a specified file in the current directory of the storage device (A drive in the sample program of Figure 8-29) connected to the external controller to the current directory of the selected storage device (memory disk in the sample program of Figure 8-29) of the 4395A, giving a file name you desire.

Note



Use a **fig8-29.lif** in the sample program disk when you transfer binary files for the LIF format. The WOPEN command in the line 370 takes its arguments in a different way.

This program, when executed, first prompts you to enter a source file name, as shown below. Enter the name of a file you want to transfer. Note that the file name of the LIF format can be distinguished between capital and small letters.

```
ENTER SOURCE FILE NAME ON CONTROLLER ?
```

Then, the program prompts you to enter a destination file name as shown below, and in this example, SAMPLE.STA (DOS format) or SAMPLE_S (LIF format) has been entered as the source file name. Enter the size correctly in bytes.

```
ENTER SOURCE FILE NAME ON CONTROLLER ?      SAMPLE.STA (SAMPLE_S)
ENTER SOURCE FILE SIZE ?
```

Then, the program prompts you to enter the destination file name, as shown below (in this example, the size of SAMPLE.STA or SAMPLE_S is 12288 bytes). Enter the file name you want to give on the destination storage device. Note that a file with the same name will be overwritten, if it already exists.

```
ENTER SOURCE FILE NAME ON CONTROLLER ?      SAMPLE.STA (SAMPLE_S)
ENTER SOURCE FILE SIZE ?                    12288
ENTER DESTINATION FILE NAME ON INSTRUMENT ?
```

```
10  !
20  ! Fig.8-29 File transfer (Controller -> Instrument)
30  !
40  DIM Src_file$[50],Dst_file$[50]
50  ASSIGN @Agt4395 TO 717
60  OUTPUT @Agt4395;"*rst"
70  !
80  MASS STORAGE IS "a:\"
90  OUTPUT @Agt4395;"STODMEMO"
100 !
110 PRINT " ENTER SOURCE FILE NAME ON CONTROLLER ?      ";
120 INPUT Src_file$
130 PRINT Src_file$
140 !
150 PRINT " ENTER SOURCE FILE SIZE ?                    ";
160 INPUT Src_size
170 PRINT Src_size
```

Figure 8-29. Sample Program: File Transfer from External Controller to 4395A (1/2)

```

180 !
190 PRINT " ENTER DESTINATION FILE NAME ON INSTRUMENT ? ";
200 INPUT Dst_file$
210 PRINT Dst_file$
220 !
230 Copy_to_instr(@Agt4395,Src_file$,Src_size,Dst_file$)
240 !
250 END
260 !
270 ! copy_to_instrument
280 !
290 SUB Copy_to_instr(@Agt4395,Src_file$,Src_size,Dst_file$)
300   DIM Img$(32)
310   Max_bsize=16384
320   !
330   ASSIGN @Src_file TO Src_file$
340   !
350   CLEAR @Agt4395
360   OUTPUT @Agt4395;"CLES"
370   OUTPUT @Agt4395;"WOPEM """;Dst_file$;"""
380   IF FNCheck_error(@Agt4395," <CPTI: wopen>")=-1 THEN SUBEXIT
390   Xfr_done=0
400   !
410   LOOP
420     SELECT (Src_size-Xfr_done)
430     CASE >Max_bsize
440       Block_size=Max_bsize
450     CASE 0
460       ASSIGN @Src_file TO *
470       OUTPUT @Agt4395;"CLOSE"
480       SUBEXIT
490     CASE ELSE
500       Block_size=(Src_size-Xfr_done)
510   END SELECT
520   Xfr_done=Xfr_done+Block_size
530   !
540   ALLOCATE Dat$(Block_size)
550   !
560   Img$="#",&VAL$(Block_size)&"A"
570   ENTER @Src_file USING Img$;Dat$
580   !
590   Img$="8A,ZZZZZ",&VAL$(Block_size)&"A"
600   OUTPUT @Agt4395 USING Img$;"WRITE #6",Block_size,Dat$,END
610   DEALLOCATE Dat$
620   IF FNCheck_error(@Agt4395," <CPTI: block write>")=-1 THEN SUBEXIT
630   END LOOP
640 SUBEND
650 !
660 ! Instrument Error Check
670 !
680 DEF FNCheck_error(@Agt4395,Str$)
690   DIM Err$(64)
700   OUTPUT @Agt4395;"OUTPERRO?"
710   ENTER @Agt4395;Err$
720   IF Err$<>"0","No error"" THEN
730     PRINT "ERROR: ";Str$;" ";Err$
740     RETURN -1
750   ELSE
760     RETURN 0
770   END IF
780 FNEND

```

Sample Program: File Transfer from External Controller to 4395A (2/2)

Lines 80 to 90 set the current directory of the external controller to A drive and sets the current directory of the 4395A to the memory disk. You can set the current directory of the 4395A to the internal flexible disk using the **STODDISK** command. The A drive in the external controller may not be detected under a certain environment of the external controller, so change the drive depending on the situation.

Lines 110 to 210 accept the entry of the source file name and its size and the destination file name.

Line 230 calls the subprogram to transfer a file from the external controller to the 4395A.

Lines 370 to 380 prepare for writing the file to the destination storage device.

Lines 420 to 510 calculate the length of the data that has not been transferred based on the source file size previously entered and the length of the data that has been already transferred.

If the length of the remaining data does not exceed 16 Kbytes, it is set as the transfer data length; otherwise, 16 Kbytes is set as the transfer data length. Note that, if the length of the data not transferred is 0 at this time, the transfer process is terminated.

Lines 560 to 570 read data, whose amount is specified by the transfer data length, from the source file.

Lines 590 to 600 write data to the destination file in the fixed length block format (see Figure R-1).

The maximum length of data transferred at a time is 16 Kbytes. Therefore, if the size of the source file is greater than 16 Kbytes, the transfer routine, lines 420 to 620, is repeated until transferring all of the data is completed.

Lines 680 to 780 provide a function to check that no error has occurred in the 4395A.

Note

To transfer a file from the external storage device to the 4395A, you must check the file size (number of bytes) in advance .

Displaying List of Files in Current Directory

This program displays the list of the files in the current directory.

```
10  !
20  ! Fig.8-30 File list
30  !
40  ASSIGN @Hp4395 TO 717
50  OUTPUT @Hp4395;"*rst"
60  !
70  Dir_instr(@Hp4395)
80  !
90  END
100 !
110 ! Dir_instr
120 !
130 SUB Dir_instr(@Hp4395)
140   DIM Stor_dev$ [5],Curr_dir$ [50],File_name$ [13]
150   !
160   OUTPUT @Hp4395;"STODMEMO?"
170   ENTER @Hp4395;A
180   IF A=1 THEN
190     Stor_dev$="MEMO"
200   ELSE
210     Stor_dev$="DISK"
220   END IF
230   OUTPUT @Hp4395;"CWD?"
240   ENTER @Hp4395;Curr_dir$
250   PRINT "["&Stor_dev$&"]: "&Curr_dir$
260   PRINT "Size [byte]   File Name"
270   PRINT "-----"
280   OUTPUT @Hp4395;"FNUM?"
290   ENTER @Hp4395;File_count
300   IF File_count>=1 THEN
310     FOR I=1 TO File_count
320       OUTPUT @Hp4395;"FNAME? ";I
330       ENTER @Hp4395;File_name$
340       OUTPUT @Hp4395;"FSIZE?  """"&File_name$&""""
350       ENTER @Hp4395;File_size
360       PRINT USING "XX,DDDDDD,XXXX,K";File_size,File_name$
370     NEXT I
380   END IF
390 SUBEND
```

Figure 8-30. Sample Program: Displaying List of Files in Current Directory of 4395A

Line 70 calls the subprogram to display the list of the files in the current directory.

Lines 160 to 250 check the storage device currently selected and its current directory name, and then display the result.

Lines 280 to 290 check the number of the files in the current directory.

If there are any files in the current directory, lines 300 to 380 check the name and size of every file and display them.

The following is the output result of the program, assuming that the selected storage device is the memory disk and the current directory, \TEST, contains 2 files, FILE1.STA (size: 24576 bytes) and FILE2.TIF (size: 16384 bytes) and 1 directory, DIR1. For size of a directory, -1 is displayed. To view the list of the files in DIR1, use the CHAD command to change the current directory to DIR1 and then execute this program again.

```
[MEMO]: \TEST
Size[byte]   File Name
-----
      -1     ..\
      -1     DIR1\
    24576     FILE1.STA
    16384     FILE2.TIF
```

Hints and Notes on Programming

This section provides hints and information that can make your program better in practical applications.

Increasing your program execution speed

Because the analyzer's CPU interleaves processing measurements and executing a program, program execution speed depends on the measurement conditions. The display process also requires processing time.

To increase program speed (increase throughput), set the analyzer to the following conditions:

- If you do not need to measure the DUT when executing a program, set TRIGGER MODE to HOLD.
- If you need to measure the DUT but do not need to display the traces on the screen, set DISPLAY ALLOCATION to ALL BASIC.
- If you need to measure the DUT and display traces, but do not need to use the marker function, preset all markers.
- When you use the I/O port, use the READIO and WRITEIO commands to input or output data to the port directly.
- If you change channels in a program, set Dual Channel to ON before changing channels to avoid the setup time for the channel. For example, when you change channels in a program, set Dual Channel to ON and Display Allocation to All BASIC to decrease the switching time between channels 1 and 2.

ANA OCH Command

If you want to retrieve measurement data from a channel that is not active, you can switch the channel effectively by using the GPIB command ANA OCH. This command swaps the channel to be processed, while the active channel remains unchanged, thereby accelerating your program execution. Refer to the ANA OCH entry in the command reference in this manual.

Note

Using ANA OCH is valid only if the dual channel function is ON by the GPIB command DUAC ON.



Self-assigning of an GPIB Address

When you want to make your program distinguish the system where it is running, the external controller, or the Instrument BASIC, it is helpful to use SYSTEM\$("SYSTEM ID") as shown below:

```
10  IF SYSTEM("SYTEM ID")="HP4395A" THEN
20  ASSIGN @Hp4395 TO 800
30  ELSE
40  ASSIGN @Hp4395 TO 717
50  ABORT 7
60  CLEAR @Hp4395
70  END IF
```

For example, the line below, which appears in most of the programs in this manual,

```
10 ASSIGN @Hp4395 TO 717 ! WHEN iBASIC is used, change "717" to "800".
```

can be replaced with the program shown above. This enables the program to assign its GPIB address by itself.

Note

In the example above, lines 50 and 60 contain the commands to reset the GPIB bus and are not essential for changing the GPIB address.

Key Stroke Recording

Key stroke recording is one of the functions provided with HP Instrument BASIC. This function allows you to write a program with a sequence of key strokes that you make on the front panel. No keyboard is required. See “Easy Program Writing” in Chapter 1 for how to use the function. The function also helps you to find the GPIB command corresponding GPIB command to the key you press.

Solving Problems on Your Program

This section provides typical troubleshooting for when your program does not work as you expected. Check that the following items are satisfied.

If There Is No Response From an Instrument on the GPIB Bus

Check all GPIB addresses and cable connections.

If the Disk Cannot Be Read

- Check that you specify the correct mass storage where your data should reside.
- Check if the disk is corrupted. You may want to verify the disk on PC.

If an GPIB Command Error Occurs

- Verify the GPIB command is appropriate and is used properly.
- Check if the 4395A operates in synchronization with the controller.

If a Query Error Occurs

- Check if the 4395A operates in synchronization with the controller.
- Check that the number of returned values is equal to that you expect in the program, if the query returns multiple values.

Introducing HP Instrument BASIC System

This chapter introduces the analyzer's HP Instrument BASIC (IBASIC) and describes how to connect and use a keyboard. Read this chapter before using HP Instrument BASIC with the analyzer for the first time. The topics covered in this chapter are:

- Overview of HP Instrument BASIC
- Controlling the analyzer
- Using HP Instrument BASIC for the first time
- Entering BASIC Statements from the front panel keys
- Getting into/out of the EDIT mode
- Editing programs in the EDIT mode
- Listing programs
- Saving programs
- Listing file names
- Getting programs
- On Key Label function
- Increasing program speed
- Pass Control Between the External Controller
- External RUN/CONTInue connector
- Graphics
- Softkeys used for HP Instrument BASIC operation

Overview of HP Instrument BASIC

HP Instrument BASIC (IBASIC) can be used for a wide range of applications from simple recording and playback of measurement sequences to remote control of other instruments.

HP Instrument BASIC is a complete system controller residing inside your analyzer. It communicates with your analyzer via GPIB commands and can also communicate with other instruments, computers, and peripherals over the GPIB interface.

The HP Instrument BASIC's programming interface includes an editor and a set of programming utilities. The utilities allow you to perform disk I/O, renumber, secure, or delete all or part of your program.

The HP Instrument BASIC command set is similar to the command set of HP 9000 Series 200/300 BASIC. Therefore, HP Instrument BASIC programs can be run on any HP BASIC workstation with few if any changes. Porting information can be found in the *HP Instrument BASIC Programming Techniques* of the *HP Instrument BASIC Users Handbook*.

Controlling the Analyzer

HP Instrument BASIC can control the analyzer (itself) through the “internal” GPIB bus. This means that an analyzer with HP Instrument BASIC includes both a controller and an analyzer in the same instrument. They are connected through an internal GPIB bus.

Note



The select code of the internal GPIB interface is 8, and the GPIB address of the analyzer can be any number from 0 to 30. In this manual, we use “800” for the device selector of the analyzer.

For more information on GPIB addresses and device selectors, see “Device Selectors” in the *HP Instrument BASIC Interfacing Techniques* of the *HP Instrument BASIC Users Handbook* and “Available I/O Interfaces and Select Codes”.

Using HP Instrument BASIC for the First Time

Allocating Screen Area for HP Instrument BASIC

Because all of the analyzer’s screen is allocated for analyzer operation after power ON, you must allocate screen area for HP Instrument BASIC when you want to use it. The analyzer provides four display allocation types. Select one of them using **DISPLAY ALLOCATION** under **Display**.

Let’s try

1. Press the following key and softkeys:

Display **MORE** **DISPLAY ALLOCATION**

2. Press the following softkey.

ALL BASIC

The screen is cleared and all of the screen area is allocated for HP Instrument BASIC.

3. Press the following softkey.

ALL INSTRUMENT

The total screen area is reallocated as the analyzer display.

4. Press the following softkey:

HALF INSTR HALF BASIC

The screen area is allocated so that the upper half of the screen is used for the analyzer operation and the lower half is used for HP Instrument BASIC.

5. Press the following softkey:

BASIC STATUS

Three blank lines appear at the display line (lower area of the screen). This area is used by HP Instrument BASIC to input commands and to display messages.

9-2 Introducing HP Instrument BASIC System

Entering BASIC Statements from the Front Panel Keys

The analyzer's HP Instrument BASIC allows you to enter and execute statements from the front panel keys (if the external mini-DIN keyboard is not connected).

Press the following key and softkeys from the front panel:

(System) **IBASIC** **MORE [1/3]** **MORE [2/3]** **COMMAND ENTRY**

The Command Entry menu is displayed on the softkey menu area, and the active entry area displays the letters, the digits 0 through 9, and some special characters including mathematical symbols. Three sets of letters can be scrolled using the step keys, **(↑)** and **(↓)**. To enter a statement, press the step keys for the desired letter set, rotate the knob until the arrow “↑” points at the first letter, then press **SELECT LETTER**. Repeat this until the complete statement is entered, then press **DONE** to execute the statement.

Getting into/out of the EDIT Mode

Pressing the following key and softkey allows you to enter the EDIT mode immediately, irrespective of Display Allocation.

Getting into the EDIT Mode

Press the following key and softkeys from the front panel:

(System) **IBASIC** **Edit**

Entering the EDIT Mode from the Keyboard

Use the following keys to enter the EDIT mode with the cursor positioned at the specified line number. The *line_number* can be omitted. Press the following key among the 3 menus which leads to the **(Shift) - (F9)** key.

EDIT *line_number* **(Enter)**

or type as follows:

EDIT *line_number* **(Enter)**

To use the keyboard, the Keyboard Input Line must be allocated on the screen. If it is not, press **(Display)** **MORE DISPLAY ALLOCATION** and select any allocation except ALL INSTRUMENT.

Getting Out of the EDIT Mode

The EDIT mode is exited by pressing **(Shift) - (Alt) - (F4)**, **(ESC)**, and **(Home)** from the keyboard (or by pressing the **END EDIT** softkey).

Editing Programs in the EDIT Mode

This section describes how to edit a program while in the EDIT mode, the topics are:

- Deleting characters
- Inserting characters
- Moving the cursor
- Scrolling lines and pages
- Jumping lines
- Inserting/deleting/recalling lines
- Clearing lines

See “The Keyboard” for more information on functions of each key.

Deleting Characters

There are two functions you can use to delete characters: “Back space” and “Delete characters.”

Back Space

Pressing **Back space** on the front panel (or on the keyboard) erases the character to the left of the cursor and moves the cursor left to the position of the erased character.

Deleting Characters

Pressing **Delete char** from the keyboard deletes the character at the cursor’s position.

Inserting Characters

The EDIT mode is always in the insert mode. Characters you type at the keyboard are inserted before the current cursor position. (Pressing **insert** performs no function.)

Moving the Cursor

The following key operations allow you to move the cursor horizontally along a line:

From the front panel	From the keyboard
Turning the knob	Pressing ◀ and ▶

Scrolling Lines and Pages

Scrolling Lines

The following key operations enable you to scroll lines up and down:

From the front panel	From the keyboard
Pressing ↑ and ↓	pressing ▲ and ▼

Scrolling Pages

Pressing **Page Up** and **Page Down** from the keyboard causes the display to scroll up and down in one page increments.

Jumping from the Current Line

Jumping to a Specified Line

You can specify a line by using a line number or a label name when jumping from the current line as follows:

```
GOTO LINE line_number Enter
```

or

```
GOTO LINE label_name Enter
```

If the label specified is not defined in the program, an error will occur.

Jumping to the Top/Bottom of a Program

Pressing the following keys allows you to jump to top or bottom of the program:

Shift - **▲**

Shift - **▼**

Inserting/Deleting/Recalling Lines

Shift - **Insert** inserts a new line above the current cursor position.

Shift - **Delete** deletes the line at which the cursor is.

RECALL LINE recalls the last deleted line.

Clearing Line

Pressing **Shift** - **End** clears a line from the current cursor position to the end of the line.

Renumbering Program Line Numbers

The `REN` command allows you to renumber the program currently in memory. You should execute the `REN` command after exiting the EDIT mode. Press the following key among the 3 menus which leads to the `(Shift) - (F9)` key.

`RENumber` `(Enter)`

or

`REN` `(Enter)`

You can specify the starting value, increment value, beginning line number, and the ending line number when renumbering a program as follows:

`RENumber` *starting_value, increment* `IN` *beginning_line_number, ending_line_number* `(Enter)`

or type as follows:

`REN` *starting_value, increment* `IN` *beginning_line_number, ending_line_number* `(Enter)`

line_label can be also use instead of *line_number*. For more information, see the *HP Instrument BASIC Language Reference* of the *HP Instrument BASIC Users Handbook*.

Listing Programs

The system can list the program on the screen and to a printer.

Listing on the Screen

You can list a program on the screen as follows:

1. Because the system lists a program in the print area, the Print Area must be allocated on the screen. For example:

`(Display)` `MORE` `DISPLAY` `ALLOCATE` `ALL` `BASIC`

All of the screen area is allocated for the print area.

2. Type as follows:

`LIST` `(Enter)`

Listing to the Printer

Note

For hard copy output, a parallel cable must connect the analyzer to the printer.



-
1. Set the output device to a printer as follows:

`PRINTER IS PRT` `(Enter)`

2. Type and press as follows:

LIST

The program is listed on the printer.

3. Set the output device to LCD as follows:

PRINTER IS CRT

Saving Programs (SAVE)

1. To use the built-in disk drive, insert a 2DD disk or 2HD disk into the disk drive.
2. If you are using a flexible disk for the first time, set the disk format to LIF or DOS and initialize the disk. See “To Save and Recall” in *Operation Manual* for the procedure.

Note



When you turn ON the 4395A, you can have it automatically execute a particular program which was backed up in the memory disk. See “Memory Disk” in Chapter 10 for how to backup a program in the memory disk.

3. If the display allocation is ALL INSTRUMENT, change the allocation to either HALF INSTRUMENT HALF BASIC or ALL BASIC. For example:

MORE DISP ALLOCATION ALL BASIC

4. Select the storage units: the built-in flexible disk drive and the RAM disk memory.

For the built-in disk drive, enter

MSI ":INTERNAL" or MSI ":INTERNAL,4,0"

For the RAM disk memory, enter

MSI ":MEMORY,0" or MSI ":MEMORY,0,0"

5. Press the following key among the 3 menus which leads to the - key. And type in the filename to which you will store the program as follows:

SAVE file_name

You can also save the file from the keyboard. Type and press as follows:

SAVE file_name

The program is stored on the disk.

Note



If you get the error -257, “File name error”, a file on the disk already has the name you are trying to use. In this case, you have three choices:

- Pick a new file name that doesn't already exist. To determine which file names are already being used, use the “CAT” command (see below).
- Replace an existing file, use the “RE-SAVE” statement.
- Purge the old file using the PURGE command, then save the new one.



Listing File Names (CAT)

Listing to Screen

Press the following key and softkeys:

1. If the display allocation is ALL INSTRUMENT or BASIC STATUS, change the allocation to either HALF INSTRUMENT HALF BASIC or ALL BASIC. For example:

 MORE DISP ALLOCATION ALL BASIC

2. Press the following key among the 3 menus which leads to the  -  key:

CAT 

You can list from the keyboard as follows:

CAT 

The file names stored on the disk are listed on the screen.

Note



Because the CAT statement outputs 80 columns to a line and the maximum number of columns to a screen is 61, each line is wrapped at the 62th column. If you do not want the list to wrap around, execute the following statement before executing the CAT command.

```
PRINTER IS CRT;WIDTH 80
```

Listing to Printer

Note



For hard copy output, a parallel cable must connect the analyzer to the printer.

1. Set the output device to be a printer as follows:

```
PRINTER IS PRT;WIDTH 80 
```

Type and press as follows:

```
CAT 
```

The program is listed on the printer.

2. Get the output device back to LCD:

```
PRINTER IS CRT 
```

Getting Programs (GET)

You can retrieve a program from the disk as follows:

1. If the display allocation is ALL INSTRUMENT, change the allocation to either HALF INSTRUMENT HALF BASIC or ALL BASIC. For example:

```
(Display) MORE DISP ALLOCATION ALL BASIC
```

2. Press the following key among the 3 menus which leads to the (Shift) - (F9) key and type the filename you want to retrieve:

```
GET file_name (Enter)
```

You can get the file from the keyboard.

On Key Label Function

The HP Instrument BASIC allows you to define softkeys from within a program. The softkey labels you define will appear when pressing ON KEY LABELS or the (Shift) - (F10) key on the Keyboard. The labels are displayed while running the program.

Example:

```
.....
100 ON KEY 1 GOTO 150
110 ON KEY 2 LABEL "Print" GOSUB Report
.....
```

You can also use the KEY statement to automatically display the label. This prevents you from pressing (Shift) - (F10) or choosing ON KEY LABELS while the user program is running. The KEY statement is used to display the softkey labels defined. The following set of statements is the same as the key strokes (System) IBASIC ON KEY LABELS :

```
.....
200 OUTPUT Hp4395;"KEY 47"      ! SYSTEM key
210 OUTPUT Hp4395;"KEY 0"      ! IBASIC softkey
220 OUTPUT Hp4395;"KEY 7"      ! ON KEY LABELS softkey
.....
```

For more information on the ON KEY statement, see the *HP Instrument BASIC Language Reference* of the *HP Instrument BASIC Users Handbook*.

Pass Control Between the External Controller

This section describes how to pass control between Instrument BASIC and the controller.

Pass Control

To pass active control to HP Instrument BASIC:

```
PASS CONTROL 717 
```

Pass Control (On External Controller)

While the 4395A has control, it is free to address devices to talk and listen as needed. As the active controller, the 4395A can send messages to and read replies back from printers and plotters.

Note



The ability to assert the GPIB interface clear line (IFC) and remote enable line (REN) are reserved for the system controller. Even when HP Instrument BASIC has active control, it is denied these functions.

```
ABORT 7      assert the interface clear line (IFC)
REMOTE 7     assert the remote enable line (REN)
```

To return active control to the system controller:

```
PASS CONTROL 721 
```

Return Control (On HP Instrument BASIC)

Or, you can return control to the external controller by resetting the GPIB as follows:

```
ABORT 7 
```

Return Control (On External Controller)

To Execute an HP Instrument BASIC Command from the External Controller

```
10 !
20 ! To Transfer the Program to iBASIC (on External Controller)
30 !
40   ABORT 7
50   ASSIGN @Hp4395 TO 717
60   INPUT "FILENAME?",File_name$
70   OUTPUT @Hp4395;"PROG:DEL:ALL"
80   OUTPUT @Hp4395;"PROG:DEF #0"
90   ASSIGN @File TO File_name$
100  ON ERROR GOTO Done
110  DIM Line$[1024]
120  LOOP
130  Line$=""
140  ENTER @File;Line$
150  OUTPUT @Hp4395;Line$
160  END LOOP
170 Done: !
180  OFF ERROR
190  OUTPUT @Hp4395;" " END
200 !
210 OUTPUT @Hp4395;"PROG:EXEC ""RUN""
220 END
```

Figure 9-1. Sample Program : To Transfer the Program to iBASIC (on External Controller)

This Program transfers the program file in the mass storage of the external controller.

Lines 70 to 80 scratch any program that currently exists in the tester's HP Instrument BASIC editor and open the editor.

Lines 90 to 160 transfer the program by line to the analyzer.

Line 190 closes the HP Instrument BASIC Editor.

Line 210 executes the transferred program.

To Load an Array in an HP Instrument BASIC Program to the External Controller

```
10 !
20 ! To Load iBASIC Program Array (on External Controller)
30 !
40 ABORT 7
50 ASSIGN @Hp4395 TO 717
60 DIM Passed(1:801,1:2)
70 OUTPUT @Hp4395;"PROG:NUMB? ""Dat"";"
80 ENTER @Hp4395;Passed(*)
90 END
```

Figure 9-2.

Sample Program : To Load HP Instrument BASIC Program Array (on External Controller)

This program retrieves the array generated in the sample program listed in Figure 3-5 when that program is executed in HP Instrument BASIC. This information is transferred to the external controller.

Lines 70 to 80 returns the program array `Dat(1:801,1:2)` of Figure 3-5 using `PROG:NUMB? "Dat"` query. The array is entered into `Passed(1:801,1:2)`.

Available I/O Interfaces and Select Codes

Available interfaces and their select codes in the analyzer's HP Instrument BASIC are listed in the following table:

Select Codes	Devices
1	LCD
2	Keyboard
7	External GPIB interface
8	Internal GPIB interface

External RUN/CONTInue Connector

You can trigger `RUN` or `CONT` of the HP Instrument BASIC program externally by applying a TTL signal through the `RUN/CONT` connector on the rear panel of the 4395A. The signal should be more than $20\mu\text{sec}$ in width and follow the negative logic. The program is triggered at the trailing edge of the pulse.

Graphics

HP Instrument BASIC adds graphics capability to the analyzer. You can draw pictures on the LCD independent of the grids and traces.

The analyzer has two screens, the instrument screen and the graphics screen. These two screens are always displayed together on the LCD and are not separately selectable. The instrument screen consists of a trace display area and a softkey label area. The HP Instrument BASIC editor is also displayed on the trace display area. The graphics screen covers the entire instrument screen as shown in Figure 9-3. The graphics screen is like an independent transparent overlay in front of the instrument screen. Therefore, you can draw figures in both the trace display and softkey label areas.

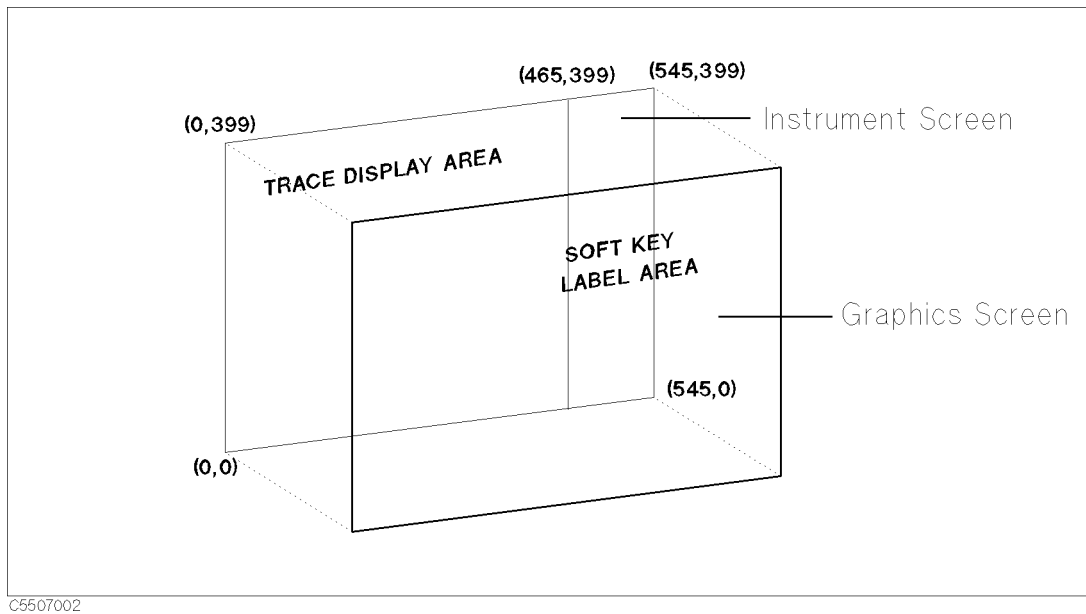

Figure 9-3. Screen Structure

Each point on the graphics screen is addressable using a coordinate address as shown in Figure 9-3. The bottom left corner is the origin (0,0) and the top right corner is the maximum horizontal and vertical end points (393,299). The MOVE and DRAW statement parameters are specified using these coordinate values. Because the aspect ratio of a graphics screen is 1, you need not adjust the aspect ratio when drawing figures.

HP Instrument BASIC Graphics Commands

The analyzer's HP Instrument BASIC has three graphics commands; MOVE, DRAW, and GCLEAR.

- | | |
|---------------|---|
| MOVE | Moves the pen from its current position to the specified coordinates. |
| DRAW | Draws a line from the current pen position to the specified coordinates. |
| GCLEAR | Clears the graphics screen, moves the pen from its current position to the origin (0,0), and selects pen 1. |

Note

The total times of executing the MOVE and DRAW commands is up to 1933, even if the pen position is not changed.

Hard Copies

Graphics hard copies can be obtained with the printing function. Select **PRINT** under **Copy**.

Initial settings

When power is turned ON, the default settings are as follows:

- MOVE 0,0

Example of Graphics Programming

This section describes an example of a simple program for drawing lines on the graphics screen.

Drawing a Straight Line

The following HP Instrument BASIC program will draw a line from coordinate (50,200) to coordinate (300,200) on the display.

```
GCLEAR           ! INITIALIZE GRAPHICS MODE
MOVE 50,200      ! MOVE PEN TO COORDINATE (50,200)
DRAW 300,200     ! DRAW A LINE TO COORDINATE (300,200)
END
```

Drawing a Circle

Trying to express all graphical images using only straight lines is tedious, slow, and difficult. This example describes a subprogram you can use to draw a circle. It can draw a circle by passing the center coordinates and the radius as arguments to the following subroutine. This subroutine can be used as a base for drawing arcs, setting different values for Theta, etc.

```
SUB Drawcircle(Centx,Centy,R)  !
  DEG                          ! USE DEGREES FOR ANGLE EXPRESSIONS
  X=Centx+R                     !
  Y=Centy                       !
  MOVE X,Y                      ! MOVE PEN TO INITIAL POINT
  For Theta=1 to 360           !
    X=INT(COS(Theta)*R+Centx)  ! NEXT X COORDINATE ON CIRCLE
    Y=INT(SIN(Theta)*R+Centy)  ! NEXT Y COORDINATE ON CIRCLE
    DRAW X,Y                   ! UNTIL STARTING POINT IS REACHED
  NEXT Theta                   !
SUBEND                          !
```

The Keyboard

This section provides the key binding information of the keyboard.

Character Entry Keys

The character entry keys are arranged in the familiar QWERTY typewriter layout, but with additional features.

- Caps** Sets the unshifted keyboard to either upper-case (which is the default after power ON) or lower-case (normal typewriter operation).
- Shift** You can enter standard upper-case and lower-case letters, using the **Shift** key to access the alternate case.
- Enter** Has three functions:
- When a running program prompts you for data, respond by typing in the requested data and then press **Enter**. This signals the program that you have provided the data and that it can resume execution.
 - When typing in program source code, the **Enter** key is used to store each line of program code.
 - After typing in a command, the **Enter** key causes the command to be executed.
- CTRL** In the EDIT mode, **CTRL** allows you to control the editor in the same as using the cursor-control, display-control, and editing keys. For more detail, see “Using **CTRL** Key in Edit Mode”.
- Backspace** Erases the character to the left of the cursor and moves the cursor to the erased character’s position on the line.
- Tab** Performs no function.

Cursor-Control and Display-Control Keys

- ▲ ▼** Allow you to scroll lines up and down in the print display area. Shifted, these keys cause the display to scroll toward the top or bottom of the display.
- ▶ ◀** Allow you to move horizontally along a line. Shifted, these keys allow you to “jump” to the left and right limits of the current line.
- Page Up** **Page Down** Cause the display to scroll up or down in one page increments.
- Home** Performs no function.

Numeric Keypad

The numerical keypad provides a convenient way to enter numbers and perform arithmetic operations. Just type in the arithmetic expression you want to evaluate, then press **Enter**. The result is displayed in the lower-left corner of the screen.

- Enter** Performs the same function as the **Enter** key. The numerical keypad serves the same function as the numerical keypad on the front panel of the analyzer.
- Num Lock** Performs no function. Pressing the **Num Lock** key causes the LED ON/OFF, but the keys are performed as the numerical keypad only.

Editing Keys

- Insert** Performs no function. The HP Instrument BASIC is always in the insert mode. The characters you type are always inserted to the left of the cursor.
- Shift** - **Insert** Inserts a new line above the cursor's current position (edit mode only).
- Delete** Deletes the character at the cursor's position.
- Shift** - **Delete** Deletes the line containing the cursor (edit mode only).
- End** Delete the line containing the cursor except the line number.
- Shift** - **End** Clears from the current cursor position to the end of the line.
- Home** Clears the entire alpha screen. In EDIT mode, this exits the EDIT mode.

Program Control Keys

The following keys allow you to control execution of the program stored in the analyzer's memory.

- Pause** **Pause** or **Alt** - **F4** pauses program execution after the current line. Pressing **Continue** in the System menu resumes program execution from the point where it paused.
- Shift** - **Alt** - **F4** stops program execution after the current line. To restart the program, press **Run** in the System menu.
- When in the editor mode, **Shift** - **Alt** - **F4** exits the edit mode.
- Ctrl** - **Break** **Ctrl** - **Break** resets program execution immediately without erasing the program from memory (**BASIC RESET**).
- Pauses program execution when the computer is performing or trying to perform an I/O operation. Press **Alt** - **F5** instead of **Pause** or **Alt** - **F4** when the computer is hung up during an I/O operation, because **Pause** or **Alt** - **F4** works only after the computer finishes the current program line.

System Control Keys

- Shift** - **Page Up** (Recall) recalls the last line the you entered, executed, or deleted. Several previous lines can be recalled this way. Recall is particularly handy to use when you mistype a line. Instead of retyping the entire line, you can recall it, edit it using the editing keys, and enter or execute it again.
- Shift** - **Page Down** moves forward through the recall stack.
- Alt** - **F3** (Run) Starts a program running from the beginning.
- Alt** - **F2** (Continue) Resumes program execution from the point where it paused.
- F12** (IBASIC) Allows you to type BASIC commands on Keyboard Input Line. If Display Allocation is ALL INSTRUMENT, pressing this key changes the Display Allocation to BASIC STATUS.
- Shift** - **F12** changes Display Allocation to ALL INSTRUMENT.

Softkeys and Softkey Control

There are eight softkeys (labeled **f1** through **f8**). The softkey labels are indicated on the right of the analyzer's screen.

Softkey Control Keys

Pressing the following:

- F9** Leads to the IBASIC menu, which controls programs and the editor.
- Shift** - **F9** leads to the BASIC menu from which to control a BASIC program. This menu is the same menu displayed when pressing **SYSTEM** **IBASIC** from the front panel.
- In the edit mode, pressing **F10** leads to the Edit System menu, which provides softkeys to conveniently enter BASIC commands.
- Shift** - **F10** (User) leads to the ON KEY LABEL menu, which are user defined softkeys in a BASIC program. (For information on getting to this menu through the HP Instrument BASIC, see "On Key Label Function".)

Softkeys

F9 and **F10** keys leads to the IBASIC menu. Pressing a softkey performs the command labeled or produces a sequence of characters on the keyboard input line (or on the "current line" in the EDIT mode).

Pressing the softkeys on the front panel of the analyzer performs the same functions as pressing the **f1** through **f8** function keys.

Softkeys Accessed from **(Shift) - (F9) Key**

IBASIC Menu

Pressing the following:

Step	Produces the command “Step” on the keyboard input line. Step executes a program at every line.
Continue	Produces the command “Continue” on the keyboard input line. Resumes program execution from the point where it paused.
Run	Produces the command “Run” on the keyboard input line. Immediately executes a program.
Pause	Produces the command “Pause” on the keyboard input line. Pauses program execution after the current program line is executed.
Stop	Produces the command “Stop” on the keyboard input line. Stops program execution after the current line. To restart the program, press Run .
EDIT	Produces the command “EDIT” on the keyboard input line. After EDIT is entered, pressing (Enter) enters the edit mode.
ON KEY LABELS	Leads to a softkey menu defined during program execution, if the softkey menu has been defined.
CAT	Produces the command “CAT”. CAT lists the contents of a mass storage directory.
SAVE	Produces the command “SAVE”. SAVE creates an ASCII file and copies program lines as strings into that file.
RE-SAVE	Produces the command “RE-SAVE”. RE-SAVE creates a specified ASCII file if it does not exist; otherwise, it rewrites a specified ASCII file by copying program lines as strings into that file.
GET	Produces the command “GET”. GET reads the specified ASCII file and attempts to store the strings into memory as program lines.
PURGE	Produces the command “PURGE”. PURGE deletes a file or directory from the directory of a mass storage media.
INITIALIZE	Produces the command “INITIALIZE”. INITIALIZE prepares mass storage media for use by the computer. When INITIALIZE is executed, any data on the media is lost.
MSI []	Produces the command “MSI []” on the keyboard input line. MSI [] specifies the mass storage. INTERNAL specifies the internal flexible disk, MEMORY specifies the RAM disk.
SCRATCH	Produces the command “SCRATCH”. The SCRATCH erases the program in memory. After SCRATCH is entered, pressing (Enter) executes the command.
RENumber	Produces the command “REN”. REN renumbers all of the program lines currently in memory.
LIST	Produces the command “LIST”. Lists the program on the screen.

COMMAND ENTRY	Leads to the Command entry menu, which allows you to execute the HP Instrument BASIC commands from the front panel keys.
CLEAR I/O	Produces the command “CLEAR I/O”. Pauses I/O operation program. To restart the program, press Continue .
RESET	Produces the command “RESET”. Aborts the program.

Softkeys Accessed from **(F10)** Key

(F10) key allows you to access three different softkey flows dependent on conditions as follows:

- Pressing **(F10)** accesses the Program Control menu
- In editor mode, pressing **(F10)** accesses the Edit System menu
- Pressing **(Shift)-(F10)** accesses the On Key Label menu.

The menus listed above are described in “Instrument BASIC Menu” in the *Operation Manual*.

Using **(CTRL)** Key in Edit Mode

In the edit mode, pressing **(CTRL)**, holding it down and pressing another key, allows you to control the editor in the same way as pressing control keys such as **(▲)**, **(▼)**, **(Insert line)**, etc.

If you press ...	It performs ...
(CTRL)-a	Moves the cursor to beginning of line, (the same function as (Shift)-(◀)).
(CTRL)-b	Moves cursor backward one character, (the same function as (◀)).
(CTRL)-d	Deletes a character, (the same function as (Delete)).
(CTRL)-e	Moves the cursor to end of the line, (the same function as (Shift)-(▶)).
(CTRL)-f	Moves cursor forward character along a line, (the same function as (▶)).
(CTRL)-g	Allows you to move the cursor to any line number or label, after press (CTRL)-g , type a line number or label name and press (Enter) , the cursor moves to the specified line, (the same function as GOTO LINE).
(CTRL)-h	Deletes backward one character, (the same function as (Back Space)).
(CTRL)-j	Performs the same function as (Enter) .
(CTRL)-k	Deletes a line from the cursor's current position to the end of the line.
(CTRL)-m	Performs the same function as (Enter) .
(CTRL)-n	Moves the cursor to the next line, (the same function as (▼)).
(CTRL)-o	Inserts a new line above the cursor's current position, (the same function as (Shift)-(Insert)).
(CTRL)-p	Moves the cursor to the previous line, (the same function as (▲)).

Run Light Indications

- (blank) Program stopped; can execute commands; CONTINUE not allowed.
- Program paused; can execute commands; CONTINUE is allowed.
- ? BASIC program waiting for input from keyboard; cannot execute commands.
- * This indication has two possible meanings:
 - Program running; CANNOT execute commands. CONTINUE not allowed.
 - System executing command entered from keyboard; CANNOT enter commands.

BASIC Commands Specific to 4395A

The following commands are *not* listed in the *HP Instrument BASIC Language Reference* of the *HP Instrument BASIC Users Handbook*, but are available in the analyzer's HP Instrument BASIC.

DATE

Keyboard Executable	Yes
Programmable	Yes
In an IF ... THEN ...	Yes

This command converts a date (given in Day Month Year) into Julian seconds.

■ Example Commands

```
PRINT DATE("21 MAY 1991")      ! Displays the date May/21/1991 in Julian seconds
SET TIMEDATE DATE("1 Jan 1991") ! Set the real time clock to
                                ! 0:00 Jan/1/1991
Days=(DATE("1 JAN 1991")-DATE("11 NOV 1990")) DIV 86400!
```

Note

The Julian seconds format is used in the real time clock and is defined as the number of seconds that passed since 0:00 Nov/24/-4713



DATE\$

Keyboard Executable	Yes
Programmable	Yes
In an IF ... THEN ...	Yes

This command formats the number of seconds into a date (DD MMM YYYY)

■ Example Commands

```
PRINT DATE$(TIMEDATE)      ! Displays the real time clock in a date format
DISP DATE$(2.111510608E+11) ! Displays 2.111510608E+11 Julian seconds in a date format
```

EXECUTE

Keyboard Executable	Yes
Programmable	Yes
In an IF ... THEN ...	Yes

This command executes specific GPIB commands faster than the **OUTPUT** statement.

■ Example Commands

```
EXECUTE "SING"
```

READIO

Keyboard Executable	Yes
Programmable	Yes
In an IF ... THEN ...	Yes

This command reads the contents of the register used for an I/O port or EXECUTE command.

Item	Description	Range
select code	numeric expression	8: EXECUTE register 15: I/O port
register number	numeric expression	0 to 800 (Select code 8) 0: I/O port

■ Example Commands

```
Ioport=READIO(15,0)      ! Substitutue data from the I/O port to Ioport

100 EXECUTE "OUTPRESO?"  ! Execute OUTPRESO? query
110 Za=READIO(8,0)       ! Substitutue the first return value from the register 0 to Za
120 Fa=READIO(8,1)       ! Substitutue the second return value from the register 1 to Fa
130 Zr=READIO(8,2)       ! Substitutue the third return value from the register 2 to Zr
140 Fr=READIO(8,3)       ! Substitutue the fourth return value from the register 3 to Fr
```

SET TIME

Keyboard Executable	Yes
Programmable	Yes
In an IF ... THEN ...	Yes

This command resets the time-of-day given by the real-time clock.

■ Example Commands

```
SET TIME TIME("22:00:30") ! Set the real time clock to 22:00:30
SET TIME Hours*3600+Minutes*60 ! Set the real time clock to Hours:Minutes
```

SET TIMEDATE

Keyboard Executable	Yes
Programmable	Yes
In an IF ... THEN ...	Yes

This command resets the absolute seconds (time and day) given by the real-time clock.

■ Example Commands

```
SET TIMEDATE DATE("4 JAN 1993")+TIME("10:00:00") ! Set the real time clock to
! 10:00 Jan/4/1993
SET TIMEDATE TIMEDATE+86400 ! Set the real time clock 1 day ahead
```

TIME

Keyboard Executable Yes
Programmable Yes
In an IF ... THEN ... Yes

This command converts data formatted as time of day (HH:MM:SS), into the number of seconds past midnight.

■ Example Commands

```
Seconds=TIME("8:37:20")           ! Seconds passed since 0:00 until 8:37:20
SET TIME TIME("8:37:20")         ! Set the real time cloc to 8:37:20
ON TIME TIME("12:10") GOSUB Lunch ! Go to "Lunch" at 12:10
```

TIMES

Keyboard Executable Yes
Programmable Yes
In an IF ... THEN ... Yes

This command converts the number of seconds past midnight into a string representing the time of day (HH:MM:SS).

■ Example Commands

```
DISP "The time is: ";TIME$(TIMEDATE) ! Shows the current time based on the real time clock
PRINT TIME$(45296)                  ! Shows the time that passed 45296 seconds since 0:00
```

WRITEIO

Keyboard Executable Yes
Programmable Yes
In an IF ... THEN ... Yes

This statement writes register data in decimal notation to a specified EXECUTE command parameter register or to a specified I/O port.

Item	Description	Range
select code	numeric expression	8: EXECUTE register 15: I/O port
register number	numeric expression	0 to 800 (Select code 8) 0: I/O port
register data	numeric expression	-2147483648 to +2147483647 0 to 255: I/O port

■ Example Commands

```
WRITEIO 15,0;12                   ! Writes 12 on the I/O port

100 WRITEIO 8,0; 100E6             ! Writes the first argument on the register 0
110 WRITEIO 8,1; 200E6             ! Writes the second argument on the register 1
```

BASIC Commands Not Implemented

The following commands are listed in the *HP Instrument BASIC Language Reference* of the *HP Instrument Users Handbook*, but are not implemented in the analyzer's HP Instrument BASIC.

- OFF CYCLE
- ON CYCLE

Note



GCLEAR and ON TIMEOUT commands are available, but the following supplementary items are added.

- GCLEAR
Moves the pen to (0,0).
 - OFF TIMEOUT and ON TIMEOUT
The interface select code is 7 only.
-

Facilitating Program Execution and Utilizing Storage Devices

You can use the 4395A's softkey interface to run a program previously saved on a storage device (floppy disk or memory disk). Also, you can have the 4395A to automatically execute a certain program whenever the power is turned ON. This chapter explains how to use these useful features as well as how to use the storage devices of the 4395A.

Topics covered include:

- Running a program through the softkey interface
- Automatically starting a program at power-ON time
- Using storage devices

Running a Program through the Softkey Interface

With the 4395A, you can run a program by just choosing the softkey associated with the program. To do so, follow these steps:

1. Open the Program Menu as illustrated below:

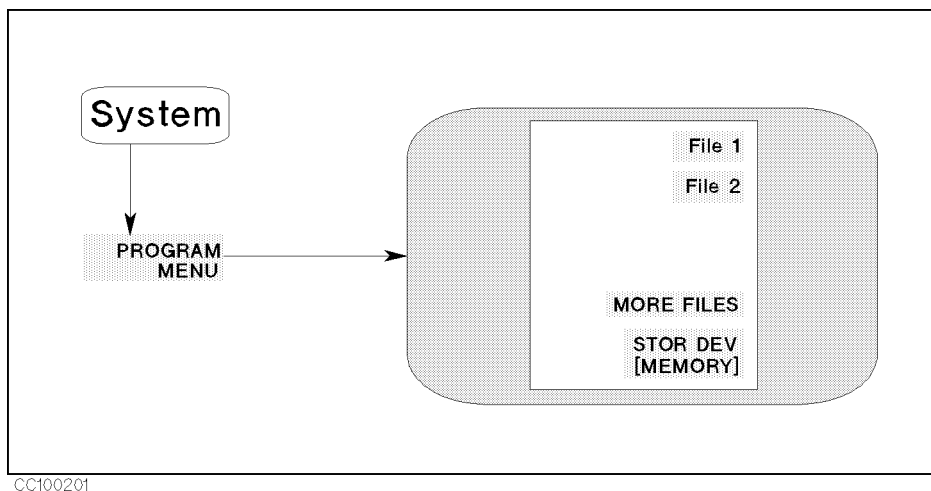

2. To tell the 4395A where program files are located, toggle the **STOR DEV** softkey as follows:

Storage Device	Toggle To
Floppy disk drive	STOR DEV [DISK]
Memory disk	STOR DEV [MEMORY]

- The 4395A displays a menu of softkeys that correspond to available program files residing on the selected storage device. Select your desired program by choosing the associated softkey. Then the 4395A executes the selected program.

Note

- The 4395A may fail to recognize a program file that was created on an external controller such as a PC. If this is the case, use Instrument BASIC to load and re-save the program without adding any file name extension.
 - For information on how to save a program file on the memory disk, refer to “Memory Disk”.
-

Automatically Starting a Program at Power-ON (AUTOST)

You can have the 4395A automatically execute a particular program whenever it is turned ON. To use this feature, save the program under the name of “AUTOST” on a floppy disk (note that the floppy disk containing the “AUTOST” program must be kept in the disk drive for the autostart feature to work).

To use the autostart feature, choose the following softkeys in order:

SYSTEM **PROGRAM MENU** **STOR DEV**

Alternatively, you can save an “AUTOST” program file on the memory disk, and back up the memory disk as explained in “Memory Disk”. In this case, the “AUTOST” program will be automatically executed from the backup copy of the memory disk next time you turn ON the 4395A.

When the power is turned ON, the 4395A checks for any “AUTOREC” file. If an “AUTOREC” file exists, it reads the information contained in the file, and then loads and executes the “AUTOST” program.

Note

If the autostart feature does not work, make sure that your selected storage device contains an “AUTOST” program.

Using Storage Devices

The 4395A has two storage devices: a floppy disk drive and a RAM disk. These storage devices support the LIF and DOS formats. The 4395A automatically identifies the data format, almost transparently to the user.

BASIC commands for setting up the storage devices include:

MSI ":INTERNAL" and MSI ":INTERNAL,4,0" are commands to select the floppy disk drive.

MSI ":MEMORY" and MSI ":MEMORY,0,0" are commands to select the memory disk.

Note



Use STODDISK(floppy disk drive) or STODMEMO(memory disk) to set up storage units that are accessed through the following GPIB commands:

- | | | | |
|--------|--------|-----------|-----------|
| • CHAD | • INID | • RESAVD | • SAVDGRA |
| • CRED | • PURG | • SAVDASC | • SAVDSTA |
| • DISF | • RECD | • SAVDDAT | |

The GPIB FILC command allows you to copy files between the floppy disk drive and memory disk.

Note



FILC does not support copying files between different data formats (LIF and DOS).

You can format a disk through the front panel interface (see Chapter 6 of *Operation Manual* or by using GPIB commands. The following is a sample program that uses GPIB commands to format a disk:

```
10 ASSIGN Hp4395 TO 800
20 OUTPUT Hp4395;"STODDISK" ! Select a disk drive
30 OUTPUT Hp4395;"DISF DOS" ! Select DOS format
40 OUTPUT Hp4395;"INID"     ! Start initialization
50 END
```

Floppy Disk Drive

- The INITIALIZE command of HP Instrument BASIC can format a disk into the 1.44 MB (2HD) format only; it does not support the 720 KB (2DD) and 270 KB formats.
- The INITIALIZE command accepts only the default format option parameter (0), which provides 256 byte sectors.
- The 4395A can read and write a DOS format disk that meets the following specifications:
 - 720 KB, 80 tracks, double-sided, 9 sectors/track
 - 1.44 MB, 80 tracks, double-sided, 18 sectors/track
- The CREATE and CREATE DIR commands are not available for a LIF format disk.

Note

The 4395A edition of HP Instrument BASIC does not support an external storage device. The MASS STORAGE IS(MSI) command accepts either “INTERNAL,4” (floppy disk drive) or “MEMORY,0” (memory disk).

Memory Disk

The 4395A allows you to use 512 KB RAM space as volatile memory disk.

The memory disk must be formatted into either DOS or LIF. If you have backed up the memory disk, turning on the power causes the 4395A to restore the memory disk from the backup copy retaining the original format, so you don't need to reformat the memory disk.

Note

When the 4395A is turned OFF, the data residing on the memory disk is lost. You can create a backup copy of the memory disk so that the memory disk is automatically restored from the backup copy next time the 4395A is turned on. To back up the memory disk, press **Save** **BACK UP MEMO DISK**. Alternatively, you can use the **STORMDISK** command over the GPIB.

Note

Backup is also important as a means of recovering your data in the event of power interruption or operator error. For example, even if you inadvertently formatted the 4395A memory disk, you could easily recover the data from the backup copy; all you have to do is turn OFF and ON the 4395A or issue the **RESTMDISK** command over GPIB.

Note

The memory disk can endure approximately 100,000 cycles of backup operation. This should be more than needed for the lifetime of the product, but you should avoid backing up the memory disk more frequently than actually needed.

Command Reference

This chapter summarizes the GPIB commands according to the equivalent front panel keys and softkeys as follows. See Appendixes A to Z for detailed description of the GPIB commands. The appendixes also describe the GPIB commands that have no corresponding front panel keys or softkeys.

About service commands, see *Service Manual*

Front Panel Key	GPIB Command
Chan 1	CHAN1
Chan 2	CHAN2
<p>Meas</p> <p>Network Analyzer</p> <p>NETWORK: A/R</p> <p>B/R</p> <p>A/B</p> <p>MORE</p> <p>NETWORK: R</p> <p>A</p> <p>B</p> <p>Return</p> <p>CONVERSION [OFF] → See Conversion menu</p> <p>S-PARAMETERS → See S-parameters menu</p> <p>ANALYZER TYPE → See Analyzer type menu</p>	<p>MEAS AR</p> <p>MEAS BR</p> <p>MEAS AB</p> <p>MEAS R</p> <p>MEAS A</p> <p>MEAS B</p>
<p>NA S-parameters menu</p> <p>Ref1: FWD S11 [A/R]</p> <p>Trans:FWD S21 [B/R]</p> <p>Trans:REV S12 [B/R]</p> <p>Ref1: REV S22 [A/R]</p> <p>INPUT PORTS → See Input port menu</p> <p>CONVERSION [OFF] → See Conversion menu</p> <p>ANALYZER TYPE → See Analyzer type menu</p> <p>Conversion menu</p> <p>CONVERSION OFF</p> <p>Z:Ref1</p> <p>Z:Trans</p> <p>Y:Ref1</p> <p>Y:Trans</p> <p>1 S</p> <p>MORE</p> <p>CONVERSION 4xPHASE</p> <p>8xPHASE</p> <p>16xPHASE</p> <p>RETURN</p> <p>RETURN</p>	<p>MEAS S11</p> <p>MEAS S21</p> <p>MEAS S12</p> <p>MEAS S22</p> <p>CONV OFF</p> <p>CONV ZREF</p> <p>CONV ZTRA</p> <p>CONV YREF</p> <p>CONV YTRA</p> <p>CONV ONEDS</p> <p>CONV MP4</p> <p>CONV MP8</p> <p>CONV MP16</p>

11-2 Command Reference

Front Panel Key	GPIB Command
Analyzer type menu NETWORK ANALYZER SPECTRUM ANALYZER IMPEDANCE ANALYZER RETURN	NA SA ZA
Spectrum Analyzer SPECTRUM: R A SUSCEPT(B) DETECTION [POSITIVE] DETECTION: POS PEAK NEG PEAK SAMPLE RETURN ANALYZER TYPE → See Analyzer type menu	MEAS R MEAS A MEAS B DET POS DET NEG DET SAM

Front Panel Key	GPIB Command
Impedance Analyzer ZA More menu 1/5 IMPEDANCE: MAG(Z) PHASE(θ_z) RESIST(R) REACT(X) MORE 1/5 FIXTURE [NONE] → See Fixture menu ANALYZER TYPE → See Analyzer type menu	MEAS IMAG MEAS IPH MEAS IRE MEAS IIM
ZA More menu 2/5 ADMITTANCE: MAG(Y) PHASE(θ_y) CONDUCT(G) SUSCEPT(B) MORE 2/5 FIXTURE [NONE] → See Fixture menu ANALYZER TYPE → See Analyzer type menu	MEAS AMAG MEAS APH MEAS ARE MEAS AIM
ZA More menu 3/5 REFL. COEF: MAG(Γ) PHASE(θ_Γ) REAL(Γ_x) IMAG(Γ_y) MORE 3/5 FIXTURE [NONE] → See Fixture menu ANALYZER TYPE → See Analyzer type menu	MEAS RCM MEAS RCPH MEAS RCR MEAS RCIM
ZA More menu 4/5 CAPCITANCE: PRL(C_p) SER(C_s) INDUCTANCE: PRL(L_p) SER(L_s) MORE 4/5 FIXTURE [NONE] → See Fixture menu ANALYZER TYPE → See Analyzer type menu	MEAS CP MEAS CS MEAS LP MEAS LS
ZA More menu 5/5 RESISTANCE: PRL(R_p) SER(R_s) D FACTOR(D) Q FACTOR(Q) MORE 5/5 FIXTURE [NONE] → See Fixture menu ANALYZER TYPE → See Analyzer type menu	MEAS RP MEAS RS MEAS D MEAS Q

11-4 Command Reference

Front Panel Key	GPIB Command
Fixture menu	
SELECT FIXTURE	
FIXTURE: NONE	FIXT NONE
16191	FIXT HP16191
16192	FIXT HP16192
16193	FIXT HP16193
16194	FIXT HP16194
USER	FIXT USED
RETURN	
SAVE USER FXTR KIT	SAVUFIXT
MODIFY [NONE]	MODIFIX
DEFINE EXTENSION	FIXE <numeric>
LABEL FIXTURE	LABEFIX <string>
KIT DONE (MODIFIED)	FIXKDONE
RETURN	

Front Panel Key	GPIB Command
<p>Format</p> <p>Network Analyzer</p> <p>FORMAT: LOG MAG</p> <p>PHASE</p> <p>DELAY</p> <p>SMITH CHART</p> <p>POLAR CHART</p> <p>MORE</p> <p>FORMAT: LIN MAG</p> <p>SWR</p> <p>REAL</p> <p>IMAGINARY</p> <p>ADMITTANCE CHART</p> <p>RETURN</p> <p>PHASE UNIT [DEG]</p> <p>EXP PHASE ON off</p> <p>PHASE UNIT [DEG]</p> <p>EXP PHASE ON off</p>	<p>FMT LOGM</p> <p>FMT PHAS</p> <p>FMT DELA</p> <p>FMT SMITH</p> <p>FMT POLA</p> <p>FMT LINM</p> <p>FMT SWR</p> <p>FMT REAL</p> <p>FMT IMAG</p> <p>FMT ADMIT</p> <p>PHAU {DEG RAD}</p> <p>EXPP {ON OFF}</p> <p>PHAU {DEG RAD}</p> <p>EXPP {ON OFF}</p>
<p>Spectrum Analyzer</p> <p>FORMAT: SPECTRUM</p> <p>NOISE</p> <p>UNIT: dBm</p> <p>dBV</p> <p>dBuV</p> <p>WATT</p> <p>VOLT</p>	<p>FMT SPECT</p> <p>FMT NOISE</p> <p>SAUNIT DBM</p> <p>SAUNIT DBV</p> <p>SAUNIT DBUV</p> <p>SAUNIT W</p> <p>SAUNIT V</p>
<p>Impedance Analyzer</p> <p>FORMAT: LIN Y-AXIS</p> <p>LOG Y-AXIS</p> <p>POLAR CHART</p> <p>SMITH CHART</p> <p>ADMITTANCE CHART</p> <p>COMPLEX PLANE</p> <p>PHASE UNIT [DEG]</p> <p>EXP PHASE ON off</p>	<p>FMT LINY</p> <p>FMT LOGY</p> <p>FMT POLA</p> <p>FMT SMITH</p> <p>FMT ADMIT</p> <p>FMT COMP</p> <p>PHAU {DEG RAD}</p> <p>EXPP {ON OFF}</p>

Front Panel Key	GPIB Command
<div style="border: 1px solid black; border-radius: 5px; padding: 2px; display: inline-block;">Display</div>	
DUAL CHAN ON OFF	DUAC {ON OFF}
DISPLAY[DATA]	DISP DATA
DISPLAY: DATA	DISP DATA
DATA→MEMORY	DATMEM
RETURN	
DATA→MEMORY	DATMEM
OVERLAY TRACES	
DATA→OVERLAY	DATOVE
SELECT PEN COLOR	PEN {1-6}
CLEAR GRAPHICS	GCLEAR
RETURN	
DATA HOLD [OFF]	
HOLD: OFF	DHOLD OFF
MAX	DHOLD MAX
MIN	DHOLD MIN
RETURN	
DATA MATH [DATA]	
DATA MATH: DATA	MATH DATA
DATA+MATH	MATH DPLM
DATA-MATH	MATH DMNM
DATA/MATH	MATH DDVM
DEFAULT GAIN & OFS	DEFGO
OFFSET	
MKR→OFFSET	MKROFS
OFFSET	DATOVAL <numeric>
AUX OFFSET	DATAOVAL <numeric>
RETURN	
GAIN	DATGAIN <numeric>
RETURN	
MORE → Display more menu	

Front Panel Key	GPIB Command
NA/SA Display more menu SPLIT DISP ON off DISP ALLDC ALL INSTRUMENT HALF INSTR HALF BASIC ALL BASIC BASIC STATUS RETURN TITLE — See Enter text menu ADJUST DISPLAY — See Adjust display menu FREQUENCY BLANK RETURN	SPLD {ON OFF} DISA ALLI DISA HIHB DISA ALLB DISA BASS TITL <string> FREO
ZA Display more menu SPLIT DISP ON off DISP ALLDC ALL INSTRUMENT HALF INSTR HALF BASIC ALL BASIC BASIC STATUS RETURN	SPLD {ON OFF} DISA ALLI DISA HIHB DISA ALLB DISA BASS

Front Panel Key	GPIB Command
EQUIV CKT MENU	
SELECT EQV CKT [A]	DISECIRC {ON OFF}
CKT A	EQUC CIRA
B	EQUC CIRB
C	EQUC CIRC
D	EQUC CIRD
E	EQUC CIRE
CALCULATE EQV PARANS	CALECPARA
SIMULATE F-CHRST	SIMFCHAR
RETURN	
DISP PARH on OFF	DISECPARA {ON OFF}
DEFINE EQV PARANS	
PARAMETER R1	DEFECR1 <numeric>
C1	DEFEC C1 <numeric>
L1	DEFEC L1 <numeric>
CO	DEFEC CO <numeric>
SIMULATE F-CHRST	SIMFCHAR
RETURN	
CALCULATE EQV PARANS	CALECPARA
SIMULATE F-CHRST	SIMFCHAR
RETURN	
TITLE → See Enter text menu	TITL <string>
ADJUST DISPLAY → See Adjust display menu	
FREQUENCY BLANK	FREO
RETURN	

Front Panel Key	GPIB Command
<p>Adjust display menu</p> <p>INTENSITY</p> <p>BACKGROUND INTENSITY</p> <p>MODIFY COLORS</p> <p>CH1 DATA → Color adjust menu</p> <p>CH1 HEN/ LIMIT LINE → Color adjust menu</p> <p>CH2 DATA → Color adjust menu</p> <p>CH2 HEN/ LIMIT LINE → Color adjust menu</p> <p>GRATICULE → Color adjust menu</p> <p>WARNING → Color adjust menu</p> <p>HORE</p> <p>TEXT → Color adjust menu</p> <p>IBASIC → Color adjust menu</p> <p>HORE</p> <p>PEN 1 → Color adjust menu</p> <p>PEN 2 → Color adjust menu</p> <p>PEN 3 → Color adjust menu</p> <p>PEN 4 → Color adjust menu</p> <p>PEN 5 → Color adjust menu</p> <p>PEN 6 → Color adjust menu</p> <p>RETURN</p> <p>RETURN</p> <p>RETURN</p> <p>DEFAULT COLORS</p> <p>SAVE COLORS</p> <p>RECALL COLORS</p> <p>RETURN</p>	<p>INTE <numeric></p> <p>BACI <numeric></p> <p>COLO CH1D</p> <p>COLO CH1M</p> <p>COLO CH2D</p> <p>COLO CH2M</p> <p>COLO GRAT</p> <p>COLO WARN</p> <p>COLO TEXT</p> <p>COLO IBT</p> <p>COLO PEN1</p> <p>COLO PEN2</p> <p>COLO PEN3</p> <p>COLO PEN4</p> <p>COLO PEN5</p> <p>COLO PEN6</p> <p>DEFC</p> <p>SVCO</p> <p>RECC</p>
<p>Color adjust menu</p> <p>TINT</p> <p>BRIGHTNESS</p> <p>COLOR</p> <p>RESET COLOR</p> <p>RETURN</p>	<p>TINT <numeric></p> <p>CBRI <numeric></p> <p>COLOR <numeric></p> <p>RSCO</p>

Front Panel Key	GPIB Command
<p>Scale Ref</p> <p>Network Analyzer</p> <p>AUTO SCALE</p> <p>SCALE/DIV</p> <p>REFERENCE POSITION</p> <p>REFERENCE VALUE</p> <p>MKR→REFERENCE</p> <p>SCALE FOR [DATA]</p> <p>D&H SCALE [COUPLE]</p> <p>ATTENUATOR MENU</p> <p>ATTEN R</p> <p>ATTEN A</p> <p>ATTEN B</p> <p>TEST SET ATTEN PT1</p> <p>TEST SET ATTEN PT2</p> <p>RETURN</p>	<p>AUTO</p> <p>SCAL <numeric></p> <p>REFP <numeric></p> <p>REFV <numeric></p> <p>MKRREF</p> <p>SCAF {DATA MEMO}</p> <p>SCAC {ON OFF}</p> <p>ATTR <numeric></p> <p>ATTA <numeric></p> <p>ATTB <numeric></p> <p>ATTP1 <numeric></p> <p>ATTP2 <numeric></p>
<p>Spectrum Analyzer</p> <p>PEAK→REFERENCE</p> <p>SCALE/DIV</p> <p>REFERENCE VALUE</p> <p>SCALE FOR [DATA]</p> <p>D&H SCALE [COUPLE]</p> <p>ATTENUATOR MENU</p> <p>ATTEN R</p> <p>ATTEN A</p> <p>ATTEN B</p> <p>ATT AUTO ON OFF</p> <p>RETURN</p>	<p>PEAKREF</p> <p>SCAL <numeric></p> <p>REFV <numeric></p> <p>SCAF {DATA MEMO}</p> <p>SCAC {ON OFF}</p> <p>ATTR <numeric></p> <p>ATTA <numeric></p> <p>ATTB <numeric></p> <p>ATTAUTO {ON OFF}</p>

Front Panel Key	GPIB Command
Impedance Analyzer AUTO SCALE SCALE/DIV REFERENCE POSITION REFERENCE VALUE HKR→REFERENCE SCALE FOR [DATA] D&H SCALE [COUPLE] MORE AUTO SCALE SCALE/DIV TOP VALUE BOTTOM VALUE HKR→REFERENCE SCALE FOR [DATA] D&H SCALE [COUPLE] MORE AUTO SCALE SCALE/DIV REFERENCE X VALUE REFERENCE Y VALUE HKR→REFERENCE SCALE FOR [DATA] D&H SCALE [COUPLE] D&H SCALE [COUPLE] MORE	AUTO SCAL <numeric> REFP <numeric> REFV <numeric> MKRREF SCAF {DATA MEMO} SCAC {ON OFF} AUTO SCAL <numeric> TOPV <numeric> BOTV <numeric> MKRREF SCAF {DATA MEMO} SCAC {ON OFF} AUTO SCAL <numeric> REFX <numeric> REFY <numeric> MKRREF SCAF {DATA MEMO} SCAC {ON OFF} SCAC {ON OFF}

Front Panel Key	GPIB Command
<p>Bw/Avg</p> <p>Network Analyzer</p> <p>AVERAGING RESTART</p> <p>AVERAGING on OFF</p> <p>AVERAGING FACTOR</p> <p>IF BW auto HAN</p> <p>IF BW</p> <p>AUTO IFBW LIMIT</p> <p>GROUP DELY APERTURE</p>	<p>AVERREST</p> <p>AVER {ON OFF}</p> <p>AVERFACT <numeric></p> <p>BWAUTO {ON OFF}</p> <p>BW <numeric></p> <p>BWLMT <numeric></p> <p>GRODAPER <numeric></p>
<p>Spectrum Analyzer</p> <p>AVERAGING RESTART</p> <p>AVERAGING on OFF</p> <p>AVERAGING FACTOR</p> <p>RES BW AUTO man</p> <p>RES BW</p> <p>RBW/SPAN RATIO</p> <p>VBW TYPE [LIN]</p> <p>VIDEO BW</p>	<p>AVERREST</p> <p>AVER {ON OFF}</p> <p>AVERFACT <numeric></p> <p>BWAUTO {ON OFF}</p> <p>BW <numeric></p> <p>BWSRAT <numeric></p> <p>VBWT {LIN LOG}</p> <p>VBW <numeric></p>
<p>Impedance Analyzer</p> <p>AVERAGING RESTART</p> <p>AVERAGING on OFF</p> <p>AVERAGING FACTOR</p> <p>IF BW auto HAN</p> <p>IF BW</p> <p>AUTO IFBW LIMIT</p>	<p>AVERREST</p> <p>AVER {ON OFF}</p> <p>AVERFACT <numeric></p> <p>BWAUTO {ON OFF}</p> <p>BW <numeric></p> <p>BWLMT <numeric></p>

Front Panel Key	GPIO Command
<p>Cal</p> <p>Network Analyzer</p> <p>CORRECTION on OFF</p> <p>CALIBRATE MENU → See NA Cal menu</p> <p>RESUME CAL SEQUENCE</p> <p>CAL KIT [7mm] → See NA Cal kit menu</p> <p>MORE</p> <p>PORT EXTENSIONS</p> <p>EXTENSIONS on OFF</p> <p>EXTENSION INPUT R</p> <p>EXTENSION INPUT A</p> <p>EXTENSION INPUT B</p> <p>EXTENSION PORT 1</p> <p>EXTENSION PORT 2</p> <p>RETURN</p> <p>VELOCITY FACTOR</p> <p>SET Z0</p> <p>ELECTRICAL DELAY MENU</p> <p>MKR → DELAY</p> <p>ELECTRICAL DELAY</p> <p>PHASE OFFSET</p> <p>RETURN</p> <p>RETURN</p>	<p>CORR {ON OFF}</p> <p>RESC</p> <p>PORE {ON OFF}</p> <p>PORTR <numeric></p> <p>PORTA <numeric></p> <p>PORTB <numeric></p> <p>PORT1 <numeric></p> <p>PORT2 <numeric></p> <p>VELOFACT <numeric></p> <p>SETZ <numeric></p> <p>MKRDELA</p> <p>ELED <numeric></p> <p>PHAO <numeric></p>
<p>NA Cal menu</p> <p>CALIBRATE:NONE</p> <p>RESPONSE</p> <p>SHORT</p> <p>OPEN</p> <p>THRU</p> <p>DONE</p> <p>RESPONSE & ISOL'N</p> <p>RESPONSE → See Response Standard menu</p> <p>ISOL'N STD</p> <p>DONE RESP ISOL'N CAL</p> <p>S11 1-PORT</p> <p>[S11]: OPEN</p> <p>SHORT</p> <p>LOAD</p> <p>DONE: 1-PORT CAL</p> <p>S22 1-PORT</p> <p>[S22]: OPEN</p> <p>SHORT</p> <p>LOAD</p> <p>DONE: 1-PORT CAL</p>	<p>CALINONE</p> <p>CALIRESP</p> <p>STANA</p> <p>STANB</p> <p>STANC</p> <p>RESPDONE</p> <p>CALIRAI</p> <p>RAIRESP</p> <p>RAISOL</p> <p>RAID</p> <p>CALIS111</p> <p>CLASS11A</p> <p>CLASS11B</p> <p>CLASS11C</p> <p>SAV1</p> <p>CALIS221</p> <p>CLASS22A</p> <p>CLASS22B</p> <p>CLASS22C</p> <p>SAV1</p>

Front Panel Key	GPIB Command
<p>FULL 2-PORT</p> <p>REFLECT'N</p> <p>(S11): OPEN</p> <p>SHORT</p> <p>LOAD</p> <p>(S22): OPEN</p> <p>SHORT</p> <p>LOAD</p> <p>REFLECT'N DONE</p> <p>TRANS-MISSION</p> <p>FWD. TRANS. THRU</p> <p>FWD. HATCH THRU</p> <p>FWD. TRANS. THRU</p> <p>FWD. HATCH THRU</p> <p>TRANS. DONE</p> <p>ISOLATION</p> <p>OHIT ISOLATION</p> <p>FWD. ISOL'N ISOL'N STD</p> <p>REV. ISOL'N ISOL'N STD</p> <p>ISOLATION DONE</p> <p>DONE: 2-PORT CAL</p>	<p>CALI FUL2</p> <p>REFL</p> <p>CLASS11A</p> <p>CLASS11B</p> <p>CLASS11C</p> <p>CLASS22A</p> <p>CLASS22B</p> <p>CLASS22C</p> <p>REFD</p> <p>TRAN</p> <p>FWDT</p> <p>FWDM</p> <p>REVT</p> <p>REVM</p> <p>TRAD</p> <p>ISOL</p> <p>OMII</p> <p>FWDI</p> <p>REVI</p> <p>ISOD</p> <p>SAV2</p>
<p>ONE PATH 2-PORT</p> <p>REFLECT'N</p> <p>OPEN</p> <p>SHORT</p> <p>LOAD</p> <p>REFLECT'N DONE</p> <p>TRANS-MISSION</p> <p>FWD. TRANS. THRU</p> <p>FWD. HATCH THRU</p> <p>TRANS. DONE</p> <p>ISOLATION</p> <p>OHIT ISOLATION</p> <p>FWD. ISOL'N ISOL'N STD</p> <p>REV. ISOL'N ISOL'N STD</p> <p>ISOLATION DONE</p> <p>DONE: 2-PORT CAL</p>	<p>CALI ONE2</p> <p>REFL</p> <p>CLASS11A</p> <p>CLASS11B</p> <p>CLASS11C</p> <p>REFD</p> <p>TRAN</p> <p>FWDT</p> <p>FWDM</p> <p>TRAD</p> <p>ISOL</p> <p>OMII</p> <p>FWDI</p> <p>REVI</p> <p>ISOD</p> <p>SAV2</p>

Front Panel Key	GPIB Command
Response standard menu SHORT OPEN THRU DONE: RESPONSE	STANA STANB STANC DONE
OPEN standard menu OPEN[H] OPEN[F] DONE: OPEN DONE: OPEN	STANA STANB DONE DONE
SHORT standard menu SHORT[H] SHORT[F] DONE: SHORT	STANA STANB DONE
LOAD standard menu defined std 1 defined std 2 defined std 3 defined std 4 defined std 5 defined std 6 defined std 7 DONE: LOAD	STANA STANB STANC STAND STANE STANF STANG DONE
THRU standard menu defined std 1 defined std 2 defined std 3 defined std 4 defined std 5 defined std 6 defined std 7 DONE: THRU	STANA STANB STANC STAND STANE STANF STANG DONE

Front Panel Key	GPIB Command
NA Cal kit menu	
CAL KIT: 7mm	CALK APC7
3.5mm	CALK APC35
N 50 Ω	CALK N50
N 75 Ω	CALK N75
USER KIT	CALK USED
SAVE USER KIT	SAVEUSEK
MODIFY [7mm]	MOD11
DEFINE STANDARD:	
STD NO.1 [SHORT] → See NA/ZA Standard type menu	DEFS 1
STD NO.2 [OPEN] → See NA/ZA Standard type menu	DEFS 2
STD NO.3 [LOAD] → See NA/ZA Standard type menu	DEFS 3
STD NO.4 [DEL/THRU] → See NA/ZA Standard type menu	DEFS 4
STD NO.5 [LOAD] → See NA/ZA Standard type menu	DEFS 5
STD NO.6 [LOAD] → See NA/ZA Standard type menu	DEFS 6
STD NO.7 [SHORT] → See NA/ZA Standard type menu	DEFS 7
STD NO.8 [OPEN] → See NA/ZA Standard type menu	DEFS 8
SPECIFY CLASS:	
SPECIFY: S11A	SPECS11A <numeric, ... >
S11B	SPECS11B <numeric, ... >
S11C	SPECS11C <numeric, ... >
SPECIFY: S22A	SPECS22A <numeric, ... >
S22B	SPECS22B <numeric, ... >
S22C	SPECS22C <numeric, ... >
MORE	

Front Panel Key	GPIB Command
SPECIFY: FWD. TRANS.	SPECFWDT <numeric, ... >
REV. TRANS.	SPECREVT <numeric, ... >
FWD. HATCH	SPECFWDM <numeric, ... >
REV. HATCH	SPECREVM <numeric, ... >
RESPONSE	SPECRESP <numeric, ... >
RESPONSE & ISO'H	SPECRESI <numeric, ... >
RETURN	
CLASS DONE (SPEC'D)	CLAD
CLASS DONE (SPEC'D)	CLAD
LABEL CLASS	
LABEL: S11A	LABES11A <string >
S11B	LABES11B <string >
S11C	LABES11C <string >
LABEL: S22A	LABES22A <string >
S22B	LABES22B <string >
S22C	LABES22C <string >
MORE	
LABEL: FWD. TRANS.	LABEFWDT <string >
REV. TRANS.	LABEREVT <string >
FWD. HATCH	LABEFWDM <string >
REV. HATCH	LABEREVM <string >
RESPONSE	LABERESP <string >
RESPONSE & ISO'H	LABERESI <string >
LABEL DONE	
LABEL DONE	
LABEL KIT	LABK <string >
KIT DONE (MODIFIED)	KITD
RETURN	

Front Panel Key	GPIB Command
<p>NA/ZA Standard type menu</p> <p>STD TYPE: OPEN</p> <p>C0</p> <p>C1</p> <p>C2</p> <p>SPECIFY OFFSET → NA/ZA Specify offset menu</p> <p>LABEL STD</p> <p>STD DONE (DEFINED)</p> <p>SHORT</p> <p>SPECIFY OFFSET → NA/ZA Specify offset menu</p> <p>LABEL STD</p> <p>STD DONE (DEFINED)</p> <p>LOAD</p> <p>SPECIFY OFFSET → NA/ZA Specify offset menu</p> <p>LABEL STD</p> <p>STD DONE (DEFINED)</p> <p>DELAY/THRU</p> <p>SPECIFY OFFSET → NA/ZA Specify offset menu</p> <p>LABEL STD</p> <p>STD DONE (DEFINED)</p> <p>ARBITRARY IMPEDANCE</p> <p>TERMINAL IMPEDANCE</p> <p>SPECIFY OFFSET → NA/ZA Specify offset menu</p> <p>LABEL STD</p> <p>STD DONE (DEFINED)</p> <p>RETURN</p>	<p>STDT OPEN</p> <p>C0 <numeric></p> <p>C1 <numeric></p> <p>C2 <numeric></p> <p>LABS <string></p> <p>STDD</p> <p>STDT SHOR</p> <p>LABS <string></p> <p>STDD</p> <p>STDT LOAD</p> <p>LABS <string></p> <p>STDD</p> <p>STDT DELA</p> <p>LABS <string></p> <p>STDD</p> <p>STDT ARBI</p> <p>TERI <numeric></p> <p>LABS <string></p> <p>STDD</p>
<p>See NA/ZA Specify offset menu</p> <p>OFFSET DELAY</p> <p>OFFSET LOSS</p> <p>OFFSET Z0</p> <p>STD OFFSET DONE</p>	<p>OFSD <numeric></p> <p>OFSL <numeric></p> <p>OFSZ <numeric></p>

Front Panel Key	GPIB Command
Impedance Analyzer	
CALIBRATE MENU	CALI IMP
OPEN	CLASIMPA
SHORT	CLASIMPB
LOAD	CLASIMPC
DONE: CORRECTION	SAVIMP
RESUME CAL SEQUENCE	RESC
FIXTURE COMPEN	
COMPEN MENU	COMP
OPEN	COMCA
SHORT	COMCB
LOAD	COMCC
DONE: COMPEN	SAVCOM
RESUME COMP SEQ	RESCOM
OPEN on OFF	COMCDATA {ON OFF}
SHORT on OFF	COMCDATB {ON OFF}
LOAD on OFF	COMCDATC {ON OFF}
RETURN	
CAL KIT [IHP 7mm]	
CAL KIT: IHP 7mm	CALK APC7
3.5mm	CALK APC35
N 50 Ω	CALK N50
N 75 Ω	CALK N75
USER KIT	CALK USED
SAVE USER KIT	SAVEUSEK
MODIFY [IHP 7mm] → CAL KIT Setup menu	MOD11

Front Panel Key	GPIB Command
<p>COMPEN KIT [USER]</p> <p>SAVE COMPEN KIT</p> <p>MODIFY [USER]</p> <p>DEFINE STANDARD</p> <p>OPEN: CONDUCT(G)</p> <p>CAP. (C)</p> <p>SHORT: RESIST. (R)</p> <p>INDUCT. (L)</p> <p>LOAD: RESIST. (R)</p> <p>INDUCT. (L)</p> <p>STD DONE (DEFINED)</p> <p>LABEL KIT</p> <p>KIT DONE (MODIFIED)</p> <p>RETURN</p> <p>MORE</p> <p>PORT EXTENSION</p> <p>EXTENSION ON off</p> <p>EXTENSION VALUE</p> <p>RETURN</p> <p>VELOCITY FACTOR</p> <p>SET Z0</p> <p>RETURN</p>	<p>SAVUCOMK</p> <p>MODICOMK</p> <p>DEFSOPENG <numeric></p> <p>DEFSOPENC <numeric></p> <p>DEFSSHORR <numeric></p> <p>DEFSSHORL <numeric></p> <p>DEFSLOADR <numeric></p> <p>DEFSLOADL <numeric></p> <p>COMSDONE</p> <p>LABECOMK <string></p> <p>COMKDONE</p> <p>PORE {ON OFF}</p> <p>PORTZ <numeric></p> <p>VELOFACT <numeric></p> <p>SETZ <numeric></p>
<p>Spectrum Analyzer</p> <p>LVL CAL DATA R</p> <p>LVL CAL DATA A</p> <p>LVL CAL DATA B</p> <p>INPUT Z</p>	<p>LVCDTR <numeric></p> <p>LVCDTA <numeric></p> <p>LVCDTB <numeric></p> <p>SETZ <numeric></p>

Front Panel Key	GPIB Command
DEFINE STANDARD	
STD NO. 1 [SHORT] → See NA/ZA Standard type menu	DEFS 1
STD NO. 2 [OPEN] → See NA/ZA Standard type menu	DEFS 2
STD NO. 3 [LOAD] → See NA/ZA Standard type menu	DEFS 3
STD NO. 4 [DEL/THRU] → See NA/ZA Standard type menu	DEFS 4
STD NO. 5 [LOAD] → See NA/ZA Standard type menu	DEFS 5
STD NO. 6 [LOAD] → See NA/ZA Standard type menu	DEFS 6
STD NO. 7 [SHORT] → See NA/ZA Standard type menu	DEFS 7
STD NO. 8 [OPEN] → See NA/ZA Standard type menu	DEFS 8
SPECIFY CLASS	
SPECIFY: INP A	SPECIMPA <numeric>
INP B	SPECIMPB <numeric>
INP C	SPECIMPC <numeric>
CLASS DONE (SPEC'D)	CLAD
LABEL CLASS	
LABEL: INP A → See Enter text menu	LBEIMPA <string>
INP B → See Enter text menu	LBEIMPB <string>
INP C → See Enter text menu	LBEIMPC <string>
LABEL DONE	
LABEL KIT	LABK <string>
KIT DONE (MODIFIED)	KITD
RETURN	

Front Panel Key	GPIB Command
<p>Sweep</p> <p>Network/Impedance Analyzer</p> <p>SWEEP TIME AUTO <i>man</i></p> <p>SWEEP TIME</p> <p>: h:m:s</p> <p>RETURN</p> <p>NUMBER OF POINTS</p> <p>COUPLED CH ON <i>off</i></p> <p>SWEEP TYPE MENU</p> <p>SWEEP TYPE: LIN FREQ</p> <p>LOG FREQ</p> <p>LIST FREQ</p> <p>POWER SWEEP</p> <p>EDIT LIST</p> <p>SEGMENT</p> <p>EDIT → See NA/ZA segment menu</p> <p>DELETE</p> <p>ADD → See NA/ZA segment menu</p> <p>CLEAR LIST</p> <p>LIST DONE</p> <p>SEGMENT WAIT</p> <p>LIST DISP [FREQ BASE]</p> <p>RETURN</p>	<p>SWETAUTO {ON OFF}</p> <p>SWET <numeric></p> <p>POIN <numeric></p> <p>COUC {ON OFF}</p> <p>SWPT LINF</p> <p>SWPT LOGF</p> <p>SWPT LIST</p> <p>SWPT POWE</p> <p>EDITLIST</p> <p>SEDI [<numeric>]</p> <p>SDEL [<numeric>]</p> <p>SADD [<numeric>]</p> <p>CLEL</p> <p>EDITDONE</p> <p>SWAI <numeric></p> <p>LISD {FBASE OBASE}</p>
<p>NA/ZA segment menu</p> <p>SEGMENT: START</p> <p>STOP</p> <p>CENTER</p> <p>SPAN</p> <p>HKR → MENU</p> <p>HKR → START</p> <p>HKR → STOP</p> <p>HKR → CENTER</p> <p>RETURN</p> <p>HDRE</p> <p>NUMBER OF POINTS</p> <p>POWER</p> <p>IF BW</p> <p>DC VOLTAGE</p> <p>DC CURRENT</p> <p>RETURN</p> <p>SEGMENT QUIT</p> <p>SEGMENT DONE</p>	<p>STAR <numeric></p> <p>STOP <numeric></p> <p>CENT <numeric></p> <p>SPAN <numeric></p> <p>MKRSTAR</p> <p>MKRSTOP</p> <p>MKRCENT</p> <p>POIN <numeric></p> <p>POWE <numeric></p> <p>BW <numeric></p> <p>DCV <numeric></p> <p>DCI <numeric></p> <p>SQUI</p> <p>SDON</p>

Front Panel Key	GPIB Command
<p>Spectrum Analyzer</p> <p>SWEEP TIME AUTO man</p> <p>SWEEP TIME</p> <p>h:m:s</p> <p>RETURN</p> <p>NUMBER OF POINTS</p> <p>SWEEP TYPE MENU</p> <p>SWEEP TYPE: LIN FREQ</p> <p>LIST FREQ</p> <p>EDIT LIST</p> <p>SEGMENT</p> <p>EDIT → See SA segment menu</p> <p>DELETE</p> <p>ADD → See SA segment menu</p> <p>CLEAR LIST</p> <p>LIST DONE</p> <p>SEGMENT WAIT</p> <p>LIST DISP [FREQ BASE]</p> <p>RETURN</p>	<p>SWETAUTO {ON OFF}</p> <p>SWET <numeric></p> <p>POIN <numeric></p> <p>SWPT LINF</p> <p>SWPT LIST</p> <p>EDITLIST</p> <p>SEDI [<numeric>]</p> <p>SDEL [<numeric>]</p> <p>SADD [<numeric>]</p> <p>CLEL</p> <p>EDITDONE</p> <p>SWAI <numeric></p> <p>LISD {FBASE OBASE}</p>
<p>SA segment menu</p> <p>SEGMENT: START</p> <p>STOP</p> <p>CENTER</p> <p>SPAN</p> <p>HKR → MENU</p> <p>HKR → START</p> <p>HKR → STOP</p> <p>HKR → CENTER</p> <p>RETURN</p> <p>MORE</p> <p>NUMBER of POINTS</p> <p>RES BW</p> <p>DC VOLTAGE</p> <p>DC CURRENT</p> <p>RETURN</p> <p>SEGMENT QUIT</p> <p>SEGMENT DONE</p>	<p>STAR <numeric></p> <p>STOP <numeric></p> <p>CENT <numeric></p> <p>SPAN <numeric></p> <p>MKRSTAR</p> <p>MKRSTOP</p> <p>MKRCENT</p> <p>POIN <numeric></p> <p>BW <numeric></p> <p>DCV <numeric></p> <p>DCI <numeric></p> <p>SQUI</p> <p>SDON</p>

Front Panel Key	GPIB Command
<p>Source</p> <p>Network/Impedance Analyzer</p> <p>POWER</p> <p>CW FREQ</p> <p>DC SRC [VOLTAGE]</p> <p>DC VOLTAGE</p> <p>DC CURRENT LIMIT</p> <p>DC OUT ON off</p>	<p>POWE <numeric></p> <p>CWFREQ <numeric></p> <p>DC??SRC CTL?? {VOLT CURR}</p> <p>DCV <numeric></p> <p>DCILMT <numeric></p> <p>DCO {ON OFF}</p>
<p>Spectrum Analyzer</p> <p>POWER</p> <p>RF OUT off ON</p> <p>DC SRC [VOLTAGE]</p> <p>DC VOLTAGE</p> <p>DC CURRENT LIMIT</p> <p>DC OUT ON off</p>	<p>POWE <numeric></p> <p>RFO {ON OFF}</p> <p>DCCTL {VOLT CURR}</p> <p>DCV <numeric></p> <p>DCILMT <numeric></p> <p>DCO {ON OFF}</p>

Front Panel Key	GPIB Command
<p>Trigger</p> <p>Network/Impedance Analyzer</p> <p>SWEEP:HOLD</p> <p>SINGLE</p> <p>NUMBER of GROUPS</p> <p>CONTINUOUS</p> <p>TRIGGER:[FREE RUN]</p> <p>FREE RUN</p> <p>EXTERNAL</p> <p>HANUAL</p> <p>TRIG EVENT[ON SWEEP]</p> <p>TRIG PLRTY POS neg</p> <p>RETURN</p> <p>MEASURE RESTART</p>	<p>HOLD</p> <p>SING</p> <p>NUMG <numeric></p> <p>CONT</p> <p>TRGS INT</p> <p>TRGS EXT</p> <p>TRGS MAN</p> <p>TRGEVE {SWE POIN}</p> <p>TRGP {POS NEG}</p> <p>REST</p>
<p>Spectrum Analyzer</p> <p>SWEEP:HOLD</p> <p>SINGLE</p> <p>NUMBER of GROUPS</p> <p>CONTINUOUS</p> <p>TRIGGER:[FREE RUN]</p> <p>FREE RUN</p> <p>EXTERNAL</p> <p>HANUAL</p> <p>GATE [LEVEL]</p> <p>GATE CTL:LEVEL</p> <p>EDGE</p> <p>GATE DELAY</p> <p>GATE LENGTH</p> <p>RETURN</p> <p>TRIG PLRTY POS neg</p> <p>RETURN</p> <p>MEASURE RESTART</p>	<p>HOLD</p> <p>SING</p> <p>NUMG <numeric></p> <p>CONT</p> <p>TRGS INT</p> <p>TRGS EXT</p> <p>TRGS MAN</p> <p>TRGS GAT</p> <p>GATCTL LEV</p> <p>GATCTL EDG</p> <p>GATDLY <numeric></p> <p>GATLEN <numeric></p> <p>TRGP {POS NEG}</p> <p>REST</p>

Front Panel Key	GPIB Command
<p>Center</p> <p>STEP SIZE AUTO man</p> <p>CENTER STEP SIZE</p> <p>#KR→CNTR STEP</p> <p>#KRA→CNTR STEP</p> <p>#KR→CENTER</p> <p>#KRA→CENTER</p> <p>PEAK→CENTER</p>	<p>CENT <numeric></p> <p>CNTSAUTO {ON OFF}</p> <p>CNTS <numeric></p> <p>MKRCSTE</p> <p>MKRDCSTE</p> <p>MKRCENT</p> <p>MKRDCENT</p> <p>PEAKCENT</p>
<p>Span</p> <p>FULL SPAN</p> <p>ZERO SPAN</p> <p>#KRA→SPAN</p>	<p>SPAN <numeric></p> <p>FULS</p> <p>SPAN 0</p> <p>MKRDSPAN</p>
<p>Start</p>	<p>STAR <numeric></p>
<p>Stop</p>	<p>STOP <numeric></p>

Front Panel Key	GPIB Command
<p>Marker</p> <p>Network/Impedance Analyzer</p> <p>SUB MKR → See Sub-marker menu</p> <p>CLEAR SUB MKR → See Sub-marker menu</p> <p>PRESET MKRS</p> <p>MKR ON [DATA]</p> <p>MKR [UNCOUPLE]</p> <p>MKR [CONT]</p> <p>ΔMODE MENU</p> <p>ΔMKR</p> <p>FIXED ΔMKR</p> <p>TRACKING ΔMKR</p> <p>ΔMODE OFF</p> <p>ΔMKR SWP PRN</p> <p>FIXED ΔMKR VALUE</p> <p>FIXED ΔMKR AUX VALUE</p> <p>RETURN</p>	<p>MKR OFF</p> <p>MKRO {DATA MEMO}</p> <p>MKRCOUP {ON OFF}</p> <p>MKRCONT {ON OFF}</p> <p>DMKR ON</p> <p>DMKR FIX</p> <p>DMKR TRAC</p> <p>DMKR OFF</p> <p>DMKRPRM <numeric></p> <p>DMKRVAL <numeric></p> <p>DMKRAUV <numeric></p>
<p>Spectrum Analyzer</p> <p>SUB MKR → See Sub-marker menu</p> <p>CLEAR SUB MKR → See Sub-marker menu</p> <p>PRESET MKRS</p> <p>MKR ON [DATA]</p> <p>MKR [UNCOUPLE]</p> <p>MKR [CONT]</p> <p>ΔMODE MENU</p> <p>ΔMKR</p> <p>FIXED ΔMKR</p> <p>TRACKING ΔMKR</p> <p>ΔMODE OFF</p> <p>ΔMKR SWP PRN</p> <p>FIXED ΔMKR VALUE</p> <p>RETURN</p>	<p>MKR OFF</p> <p>MKRO {DATA MEMO}</p> <p>MKRCOUP {ON OFF}</p> <p>MKRCONT {ON OFF}</p> <p>DMKR ON</p> <p>DMKR FIX</p> <p>DMKR TRAC</p> <p>DMKR OFF</p> <p>DMKRPRM <numeric></p> <p>DMKRVAL <numeric></p>
<p>Sub-marker menu</p> <p>SUB MKR 1</p> <p>2</p> <p>3</p> <p>4</p> <p>5</p> <p>6</p> <p>7</p> <p>RETURN</p>	<p>SMKR1 {ON OFF}</p> <p>SMKR2 {ON OFF}</p> <p>SMKR3 {ON OFF}</p> <p>SMKR4 {ON OFF}</p> <p>SMKR5 {ON OFF}</p> <p>SMKR6 {ON OFF}</p> <p>SMKR7 {ON OFF}</p>

Front Panel Key	GPIB Command
Marker →	
MKR → CENTER	MKRCENT
MKR → START	MKRSTAR
MKR → STOP	MKRSTOP
MKR → REFERENCE	MKRREF
PEAK → CENTER	PEAKCENT
MKR ZOOM	MKRZM
ZOOMING APERTURE	ZMAPER <numeric>
MKR → XCH MENU	
MKR → XCH CENTER	XMKRCENT
MKR → XCH START	XMKRSTAR
MKR → XCH STOP	XMKRSTOP
PEAK → XCH CENTER	XPEAKCENT
MKR XCH ZOOM	XMKRZM
ZOOMING APERTURE	ZMAPER <numeric>
RETURN	

Front Panel Key	GPIB Command
<p>Search</p> <p>Network/Impedance Analyzer</p> <p>SEARCH: PEAK → See Peak menu</p> <p>MAX</p> <p>MIN</p> <p>TARGET</p> <p>TARGET</p> <p>SEARCH LEFT</p> <p>SEARCH RIGHT</p> <p>SUB MKR → See Sub-marker menu</p> <p>RETURN</p> <p>MULTIPLE PEAKS → See Print setup menu</p> <p>WIDTHS [OFF]</p> <p>SEARCH IN</p> <p>SEARCH OUT</p> <p>WIDTHS on OFF</p> <p>WIDTH VALUE</p> <p>HKRVAL/√2</p> <p>HKRVAL*√2</p> <p>HKRVAL/2</p> <p>FIXED VALUE</p> <p>RETURN</p> <p>RETURN</p> <p>SRCH TRACK on OFF</p> <p>SRCH RANGE MENU → See Search range menu</p>	<p>SEAM PEAK</p> <p>SEAM MAX</p> <p>SEAM MIN</p> <p>SEAM TARG</p> <p>SEATARG <numeric></p> <p>SEAL</p> <p>SEAR</p> <p>WIDSIN</p> <p>WIDSOUT</p> <p>WIDT {ON OFF}</p> <p>WIDV <numeric></p> <p>WIDVTYPE DIVS2</p> <p>WIDVTYPE MULS2</p> <p>WIDVTYPE DIV2</p> <p>WIDVTYPE FIX</p> <p>TRACK {ON OFF}</p>
<p>Peak menu</p> <p>PEAK</p> <p>NEXT PEAK</p> <p>NEXT PEAK LEFT</p> <p>NEXT PEAK RIGHT</p> <p>PEAK DEF MENU → See Peak definition menu</p> <p>SUB MKR → See Sub-marker menu</p> <p>RETURN</p>	<p>SEAM PEAK</p> <p>SEANPK</p> <p>SEANPKL</p> <p>SEANPKR</p>
<p>Print setup menu</p> <p>SEARCH: PEAKS ALL</p> <p>PEAKS RIGHT</p> <p>PEAKS LEFT</p> <p>PEAK DEF MENU → See Peak definition menu</p> <p>SRCH TRACK on OFF</p> <p>RETURN</p>	<p>SEAM PKSA</p> <p>SEAM PKSR</p> <p>SEAM PKSL</p> <p>TRACK {ON OFF}</p>

Front Panel Key	GPIB Command
Search range menu PART SRCH on OFF MKRA → SEARCH RNG MKR → LEFT RNG MKR → RIGHT RNG RETURN	PARS {ON OFF} SEARSTR SEARSTRL SEARSTRR
NA/ZA Define peak menu THRESHOLD on OFF THRESHOLD VALUE MKR → THRESHOLD PEAK PLRTY POS neg PEAK DEF: ΔX PEAK DEF: ΔY MKR → PEAK DELTA RETURN	PKTHRE {ON OFF} PKTHVAL <numeric> MKRTHRE PKPOL {POS NEG} PKDLTX <numeric> PKDLTY <numeric> MKRPKD
Spectrum Analyzer SEARCH: PEAK → See Peak menu MAX MIN MULTIPLE PEAKS → See Print setup menu SGNL TRACK on OFF SRCH TRACK on OFF SRCH RANGE MENU → See Search range menu	SEAM PEAK SEAM MAX SEAM MIN SGTRK {ON OFF} TRACK {ON OFF}
SA Define peak menu THRESHOLD on OFF THRESHOLD VALUE MKR → THRESHOLD PEAK DEF: ΔY RETURN	PKTHRE {ON OFF} PKTHVAL <numeric> MKRTHRE PKDLTY <numeric>

Front Panel Key	GPIB Command
<p>Utility</p> <p>Network/Impedance Analyzer</p> <p>MKR LIST on OFF</p> <p>STATISTICS on OFF</p> <p>MKR TIME on OFF</p> <p>SMTH/POLAR MENU</p> <p>REAL IHAG</p> <p>LIN HAG PHASE</p> <p>LOG HAG PHASE</p> <p>R+jX</p> <p>G+jB</p> <p>SWR PHASE</p> <p>RETURN</p>	<p>MKRL {ON OFF}</p> <p>MEASTAT {ON OFF}</p> <p>MKRTIME {ON OFF}</p> <p>CIRF RI</p> <p>CIRF LIN</p> <p>CIRF LOG</p> <p>CIRF RX</p> <p>CIRF GB</p> <p>CIRF SWR</p>
<p>Spectrum Analyzer</p> <p>MKR LIST on OFF</p> <p>STATISTICS on OFF</p> <p>MKR TIME on OFF</p> <p>NOISE F0RH on OFF</p> <p>MKR UNIT MENU</p> <p>UNIT: dBm</p> <p>dBV</p> <p>dBuV</p> <p>WATT</p> <p>VOLT</p> <p>RETURN</p>	<p>MKRL {ON OFF}</p> <p>MEASTAT {ON OFF}</p> <p>MKRTIME {ON OFF}</p> <p>MKRNOI {ON OFF}</p> <p>MKRUNIT DBM</p> <p>MKRUNIT DBV</p> <p>MKRUNIT DBUV</p> <p>MKRUNIT W</p> <p>MKRUNIT V</p>

Front Panel Key	GPIO Command
<p>System</p> <p>PROGRAM MENU</p> <p>STOR DEV [DISK]</p> <p>LIMIT MENU → See Limit test menu</p> <p>RECALL MESSAGE</p> <p>MODE</p> <p>SET CLOCK</p> <p>TIME HH:MM:SS</p> <p> HOUR</p> <p> MIN</p> <p> SEC</p> <p> ENTER</p> <p> CANCEL</p> <p>DATE DD/MM/YY</p> <p> MONTH</p> <p> DAY</p> <p> YEAR</p> <p> ENTER</p> <p> CANCEL</p> <p>DATE MODE: MonDayYear</p> <p> DayMonYear</p> <p> RETURN</p> <p>BEEP DONE ON off</p> <p>BEEP WARN on OFF</p> <p>FIRMWARE VERSION</p> <p> RETURN</p>	<p>STOD {DISK MEMO}</p> <p>SETCTIME <hour, minute, second></p> <p>SETCDATE <year, month, day></p> <p>MONDYEAR</p> <p>DAYMYEAR</p> <p>BEEPDONE {ON OFF}</p> <p>BEEPWARN {ON OFF}</p> <p>DIAG:FREV?</p>

Front Panel Key	GPIB Command
Limit test menu LIMIT LINE on OFF LIMIT TEST on OFF BEEP FAIL on OFF EDIT LIMIT LINE SEGMENT EDIT — Limit line entry menu DELETE ADD CLEAR LIST DONE LIMIT LINE OFFSETS SWP PARAM OFFSET AMPLITUDE OFFSET HKR—AMP. OFS. RETURN RETURN	LIMILINE {ON OFF} LIMITEST {ON OFF} BEEPFAIL {ON OFF} EDITLIML LIMSEDI <numeric> LIMSEDI LIMSDEL LIMSADD LIMCLEL LIMEDONE LIMIPRMO <numeric> LIMIAMPO <numeric> MKRAMPO
Limit line entry menu SWP PARAM HKR—SWP PARAM UPPER LIMIT LOWER LIMIT DELTA LIMIT MIDDLE VALUE HKR—MIDDLE DONE	LIMPRM <numeric> MKRSWPRM LIMU <numeric> LIML <numeric> LIMD <numeric> LIMM <numeric> MKRMIDD LIMSDON
Local SYSTEM CONTROLLER ADDRESS-ABLE ONLY SET ADDRESSES ADDRESS: INSTR ADDRESS: CONTROLLER RETURN	ADDRCONT <numeric>
Preset	PRES

Front Panel Key	GPIB Command
<p>Copy</p> <p>PRINT [STANDARD]</p> <p>COPY ABORT</p> <p>COPY SKEY ON off</p> <p>COPY TIME on OFF</p> <p>PRINT SETUP → See Print setup menu</p> <p>ORIENT [[PORTRAIT]</p> <p>FORM FEED ON off</p> <p>MORE → See Copy more menu</p>	<p>PRINALL</p> <p>COPA</p> <p>PRSOFT {ON OFF}</p> <p>COPT {ON OFF}</p> <p>LANDSCAPE {ON OFF}</p> <p>FORMFEED {ON OFF}</p>
<p>NA Copy more menu</p> <p>LIST VALUES → See Screen menu</p> <p>OPERATING PARAMETERS → See Screen menu</p> <p>CAL KIT DEFINITION → See Copy cal kit menu</p> <p>LIST SWEEP TABLE → copy list sweep menu</p> <p>LIMIT TEST TABLE → See Copy limit test menu</p> <p>RETURN</p>	<p>LISV</p> <p>OPEP</p>
<p>SA Copy more menu</p> <p>LIST VALUES → See Screen menu</p> <p>OPERATING PARAMETERS → See Screen menu</p> <p>LIST SWEEP TABLE → See Copy list sweep menu</p> <p>LIMIT TEST TABLE → See Copy limit test menu</p> <p>RETURN</p>	<p>LISV</p> <p>OPEP</p>
<p>ZA Copy more menu</p> <p>LIST VALUES → See Screen menu</p> <p>OPERATING PARAMETERS → See Screen menu</p> <p>CAL KIT DEFINITION → See Copy cal kit menu</p> <p>COMPEN KIT DEFINITION → See Copy compen kit menu</p> <p>LIST SWEEP TABLE → See Copy list sweep menu</p> <p>LIMIT TEST TABLE → See Copy limit test menu</p> <p>RETURN</p>	<p>LISV</p> <p>OPEP</p>

Front Panel Key	GPIB Command
Print setup menu PRINT STANDARD COLOR PRINT COLOR [FIXED] DPI TOP MARGIN LEFT MARGIN DEFAULT SETUP RETURN	PRIS PRIC PRIC {FIXE VARI} DPI <numeric> TMARG <numeric> LMARG <numeric> DFLT
Screen menu PRINT [STANDARD] COPY ABORT COPY TIME on OFF PRINT SETUP → See Print setup menu NEXT PAGE PREV PAGE RESTORE DISPLAY	PRINALL COPA COPT {ON OFF} NEXP PREP RESD
Copy cal kit menu STANDARD DEFINITION → See Copy standard no. menu CLASS ASSIGNMENT RETURN	CALCASSI
Copy limit test menu DISPLAY LIST DISP MODE: UPR & LWR MID & DLT RETURN	DISLLIST DISMAMP UL DISMAMP MD
Copy list sweep menu DISPLAY LIST DISP MODE: ST & SP CTR & SPAN RETURN	DISL DISMPRM STSP DISMPRM CTSP
Copy standard no. menu STD NO.1 STD NO.2 STD NO.3 STD NO.4 STD NO.5 STD NO.6 STD NO.7 STD NO.8	CALS 1 CALS 2 CALS 3 CALS 4 CALS 5 CALS 6 CALS 7 CALS 8

Front Panel Key	GPIB Command
<p>Save</p> <p>STATE</p> <p>DATA ONLY</p> <p>SAVE BINARY</p> <p>SAVE ASCII</p> <p>DEFINE SAVE DATA → See Define save data menu</p> <p>STOR DEV [DISK]</p> <p>RETURN</p> <p>GRAPHICS</p> <p>RE-SAVE FILE</p> <p>BACK UP MEMO DISK</p> <p>FILE UTILITIES</p> <p>PURGE FILE</p> <p>CREATE DIRECTORY</p> <p>CHANGE DIRECTORY</p> <p>COPY FILE</p> <p>INITIALIZE DISK</p> <p>INIT DISK: YES</p> <p>FORMAT [LIF]</p> <p>STOR DEV [DISK]</p> <p>RETURN</p> <p>STOR DEV [DISK]</p> <p>RETURN</p> <p>STOR DEV [DISK]</p>	<p>SAVDSTA <string></p> <p>SAVDDAT <string></p> <p>SAVDASC <string></p> <p>STOD{DISK MEMO}</p> <p>SAVDTIF <string></p> <p>RESAVD <string></p> <p>STORMDISK</p> <p>PURG <string></p> <p>CRED <string></p> <p>CHAD <string></p> <p>FILC <string>, <string>, <string>, <string></p> <p>INID</p> <p>DISF {LIF DOS}</p> <p>STOD{DISK MEMO}</p> <p>STOD{DISK MEMO}</p> <p>STOD{DISK MEMO}</p> <p>STOD{DISK MEMO}</p>
<p>Define save data menu</p> <p>RAW on OFF</p> <p>CAL on OFF</p> <p>DATA on OFF</p> <p>MEM on OFF</p> <p>DATA TRACE on OFF</p> <p>MEM TRACE on OFF</p> <p>RETURN</p>	<p>SAVRAW {ON OFF}</p> <p>SAVCAL {ON OFF}</p> <p>SAVDAT {ON OFF}</p> <p>SAVMEM {ON OFF}</p> <p>SAVDTRC {ON OFF}</p> <p>SAVMTRC {ON OFF}</p>
<p>Recall</p> <p>file name</p> <p>STOR DEV [DISK]</p>	<p>STOD{DISK MEMO}</p>

Manual Changes

Introduction

This appendix contains the information required to adapt this manual to earlier versions or configurations of the analyzer than the current printing date of this manual. The information in this manual applies directly to the 4395A Network/Spectrum Analyzer serial number prefix listed on the title page of this manual.

Manual Changes

To adapt this manual to your 4395A, see Table 12-1 and Table 12-2, and make all the manual changes listed opposite your instrument's serial number and firmware version.

Instruments manufactured after the printing of this manual may be different from those documented in this manual. Later instrument versions will be documented in a manual changes supplement that will accompany the manual shipped with that instrument. If your instrument's serial number is not listed on the title page of this manual or in Table 12-1, it may be documented in a *yellow MANUAL CHANGES* supplement.

In additions to change information, the supplement may contain information for correcting errors (Errata) in the manual. To keep this manual as current and accurate as possible, Agilent Technologies recommends that you periodically request the latest *MANUAL CHANGES* supplement.

For information concerning serial number prefixes not listed on the title page or in the *MANUAL CHANGE* supplement, contact the nearest Agilent Technologies office.

Turn on the line switch or execute the `*IDN?` command by GPIB to confirm the firmware version.

An example of `*IDN?` command execution:

```
10 ALLOCATE A$[50]
20 OUTPUT 717;"*IDN?"
30 ENTER 717;A$
40 PRINT A$
50 END
```

Table 12-1. Manual Changes by Serial Number

Serial Prefix or Number	Make Manual Changes

Table 12-2. Manual Changes by Firmware Version

Version	Make Manual Changes
REV 1.00	Change 1

Serial Number

Agilent Technologies uses a two-part, nine-character serial number that is stamped on the serial number plate (see Figure 12-1) attached to the rear panel. The first four digits and the letter are the serial prefix and the last five digits are the suffix.



Figure 12-1. Serial Number Plate

Change 1

The firmware revision 1.00 does not support the following commands. Please delete the descriptions about these commands in this manual.

CLOSE

CWD?

FNAME?

FNUM?

FSIZE?

READ?

ROPEN

WOPEN

WRITE

Commands in Entry Block A

ADDRCONT \square \langle numeric \rangle

Sets the GPIB address the analyzer will use to communicate with the external controller.
 (ADDRESS: CONTROLLER under (Local))

Parameter	Range	Unit
\langle numeric \rangle	0 to 30	

■ Query Response

$\{$ numeric $\}$ \langle new line \rangle \langle ^END \rangle

ANAOCH{1|2}

Selects channel 1 or 2 for analysis.

This command has effects on the commands listed below:

CIRF	MKRTHRE	SAUNIT
DMKR {ON FIX TRAC}	MKRTIME	SEAL
DMKR OFF	MKRVAL?	SEAM
DMKRAUV	OUTPDMKR?	SEANPK
DMKRPRM	OUTPDTRC?	SEANPKL
DMKRVAL	OUTPDTRCP?	SEANPKR
INPUDTRC	OUTPFAIP?	SEAR
LIMIAMPO	OUTPLIMF?	SEARSTR
LIMILINE	OUTPLIML?	SEARSTRL
LIMIPRMO	OUTPLIMM?	SEARSTRR
LIMITEST	OUTPMKR?	SEATARG
MEASTAT	OUTPMSTA?	SMKR{1-7}
MKR OFF	OUTPMTRC?	SMKRAUV{1-7}?
MKR ON	OUTPMTRCP?	SMKRP{1-7}
MKRAMPO	OUTPMWID?	SMKRPRM{1-7}
MKRAUV?	OUTPSMKR{1-7}?	SMKRVAL{1-7}?
MKRDISP	PARS	TRACK
MKRL	PKDLTX	WIDSIN
MKRNOI	PKDLTY	WIDSOUT
MKRO	PKPOL	WIDT
MKRP	PKTHRE	WIDV
MKRPKD	PKTHVAL	WIDVTYPE
MKRPRM	PRSMKRS	

ANAOCH{1|2}

■ Query Response

Parameter	Description
OFF or 0	Analysis for channel 1 (or 2) is off.
ON or 1	Analysis for channel 1 (or 2) is on.

ATT[R|A|B]□<numeric>[DB]

Controls the attenuation at port R, A or B.

Parameter	Range	Unit
<numeric>	0, 10, 20, 30, 40, 50	dB

■ Query Response

{numeric} <new line><^END>

ATTAUTO□{OFF|ON|0|1}

Sets the automatic and manual spectrum analyzer input attenuator of the S input. (Spectrum analyzer only) (ATTEN AUTO man under Scale Ref)

When the automatic attenuator is selected, the value selected ensures that the level meets the following equation:

$$\text{Attenuator value(dB)} = (\text{Reference value}) - (20\text{dB})$$

Parameter	Description
OFF or 0	Manual attenuator
ON or 1	Automatic attenuator

■ Query Response

{0|1} <new line><^END>

ATTP {1|2} □ <numeric> [DB]

Controls the attenuation at port 1 or port 2 of an S-parameter Test Set connected to the analyzer. (Network analyzer only) (ATTENUATOR PORT 1 under Source)

Parameter	Range	Unit
<numeric>	0, 10, 20, 30, 40, 50, 60, 70	dB

■ Query Response

{numeric} <new line><^END>

AUTO

Brings the trace data, defined by the SCAF command, in view on the display. (Network and impedance analyzers only) (AUTO SCALE under Scale Ref; No query)

AVER □ {OFF|ON|0|1}

Turns the averaging function ON or OFF for the active channel. (AVERAGING ON off under Bw/Avg)

Parameter	Description
OFF or 0	Averaging function OFF
ON or 1	Averaging function ON

■ Query Response

{0|1} <new line><^END>

AVERFACT \square $\langle numeric \rangle$

Makes the averaging factor for the active function. (AVERAGING FACTOR under Bw/Avg)

Parameter	Range	Unit
$\langle numeric \rangle$	1 to 999	

■ Query Response

{*numeric*} \langle new line \rangle \langle ^END \rangle

AVERREST

Resets the sweep-to-sweep averaging and restarts the sweep count at 1 at the beginning of the next sweep. (AVERAGING RESTART under Bw/Avg; No query)

B

Commands in Entry Block B

BACI□<numeric>[PCT]

Sets the background intensity of the display as a percent of the white level.
(BACKGROUND INTENSITY under Display)

Parameter	Range	Unit
<numeric>	0 to 100	%

■ Query Response

{numeric} <new line><^END>

BEEPDONE□{OFF|ON|0|1}

Sets an annunciator that sounds to indicate completion of certain operations such as calibration or instrument state save. (BEEP DONE ON off under System)

Parameter	Description
OFF or 0	Operation completion beeper OFF
ON or 1	Operation completion beeper ON

■ Query Response

{0|1} <new line><^END>

BEEPFAIL □ {OFF|ON|0|1}

Turns the limit fail beeper ON or OFF. When the limit testing is ON and the fail beeper is ON, a beep is emitted each time a limit test is performed and a failure is detected.

(BEEP FAIL ON off under (System))

Parameter	Description
OFF or 0	Limit fail beeper OFF
ON or 1	Limit fail beeper ON

■ Query Response

{0|1} <new line><^END>

BEEPWARN □ {OFF|ON|0|1}

Sets the warning annunciator. When the annunciator is ON, it sounds a warning when a cautionary message is displayed. (BEEP WARN ON off under (System))

Parameter	Description
OFF or 0	Warning beeper OFF
ON or 1	Warning beeper ON

■ Query Response

{0|1} <new line><^END>

BLIGHT □ {OFF|ON|0|1}

Sets backlighting the LCD screen ON or OFF.

Parameter	Description
OFF or 0	Backlighting OFF
ON or 1	Backlighting ON

■ Query Response

{0|1} <new line><^END>

BOTV□<numeric>

Defines the bottom border of the display and adjusts the scale value. (**BOTTOM VALUE** under **Scale Ref**); Network and impedance analyzers only)

Parameter	Range	Unit
<numeric>	-1×10 ⁹ to 1×10 ⁹	y-axis unit

■ Query Response

{numeric} <new line><^END>

BW□<numeric>[HZ]

Sets the bandwidth value for IF bandwidth reduction, or sets the IF bandwidth of the list sweep table. This command is valid only if the automatic IF bandwidth setting is off by **BWAUTO OFF** command. (Network and impedance analyzers) (**IF BW** under **Bw/Avg**), or **IF BW** under **Sweep**)

Sets the bandwidth value for the resolution bandwidth reduction, or sets the resolution bandwidth of the list sweep table. This command is valid only if the automatic resolution bandwidth setting is off by **BWAUTO OFF** command. (Spectrum analyzer) (**RES BW** under **Bw/Avg**), or **RES BW** under **Sweep**)

Parameter	Range	Unit
<numeric>	2, 10, 30, 100, 300, 1000 (=1k), 3000 (=3k), 10000 (=10k), 30000 (=30k) (Network and impedance analyzers)	
	1, 3, 10, 30, 100, 300, 1000 (=1k), 3000 (=3k), 10000 (=10k), 30000 (=30k), 100000 (=100k), 300000 (=300k), 1000000 (=1M), 3000000 (=3M) (span>0 in spectrum analyzer)	Hz
	3000 (=3k), 5000 (=5k), 10000 (=10k), 20000 (=20k), 40000 (=40k), 100000 (=100k), 200000 (=200k), 400000 (=400k), 800000 (=800k), 1500000 (=1.5M), 3000000 (=3M), 5000000 (=5M) (span=0 in spectrum analyzer)	Hz

■ Query Response

{numeric} <new line><^END>

BWAUTO \square {OFF|ON|0|1}

When log frequency sweeping mode is selected, sets either the automatic or manual IF bandwidth ON. (Network and impedance analyzers) (RES BW AUTO man under Bw/Avg)

When linear frequency sweeping mode is selected, sets either the automatic or manual resolution bandwidth ON. (Spectrum analyzer only) (RES BW AUTO man under Bw/Avg)

Parameter	Description
OFF or 0	Manually sets the IF bandwidth or resolution bandwidth
ON or 1	Automatically sets the IF bandwidth or resolution bandwidth

■ Query Response

{0|1} <new line><^END>

BWLMT <numeric>

Sets the limit value for IF BW(IF bandwidth). (Network and impedance analyzers only)

This command is valid only if the automatic IF bandwidth setting is on by BWAUTO ON command.

Parameter	Range	Unit
<numeric>	2, 10, 30, 100, 300, 1000 (=1k), 3000 (=3k), 10000 (=10k), 30000 (=30k)	??Hz??

BWSRAT \square <numeric> [PCT]

Sets the RBW/SPAN (resolution bandwidth/span) ratio that specifies the resolution bandwidth in the AUTO mode. (Spectrum analyzer only) (RBW/SPAN RATIO under Bw/Avg)

This command is valid only if the automatic resolution bandwidth setting is on by BWAUTO ON command.

Parameter	Range	Unit
<numeric>	0.01 to 10 (relative to span)	%

■ Query Response

{numeric} <new line><^END>

C

Commands in Entry Block C (*C included)

C0□<numeric>

Enters the C_0 term, which is the constant term of the capacitance model equation. (Network and impedance analyzers only) (C0 under Cal); No query

Parameter	Range	Unit
<numeric>	-10000 to 10000 ($\times 10^{-15}$)	F

■ Query Response

{numeric} <new line><^END>

C1□<numeric>

Enters the C_1 term, which is the constant term of the capacitance model equation. (Network and impedance analyzers only) (C1 under Cal); No query

Parameter	Range	Unit
<numeric>	-10000 to 10000 ($\times 10^{-27}$)	F/Hz

■ Query Response

{numeric} <new line><^END>

C2 □ <numeric>

Enters the C₂ term, which is the constant term of the capacitance model equation. (Network and impedance analyzers only) (C2 under Cal); No query)

Parameter	Range	Unit
<numeric>	-10000 to 10000 ($\times 10^{-36}$)	F/Hz ²

■ Query Response

{numeric} <new line><^END>

CALCASSI

Shows the tabular listing of the calibration kit class assignment. (CLASS ASSIGNMENT under Copy); No query)

CALECPARA

Calculates and displays the equivalent circuit parameters. (CALCULATE EQV PARAMS under Display); No query; Impedance analyzer only)

CALI □ {NONE|RESP|RAI|S111|S221|FUL2|ONE2|IMP}

Selects the measurement calibration type. (Network and impedance analyzers only) (CALIBRATE:NONE, RESPONSE, RESPONSE & ISOL'N, S11 1-PORT, S22 1-PORT, FULL 2-PORT, ONE PATH 2-PORT under Cal) of network analyzer mode or CALIBRATE MENU under Cal) of impedance analyzer mode.)

Parameter	Description
NONE	No calibration (Network and impedance analyzers only) ¹
RESP	Response measurement calibration (Network analyzer only)
RAI	Response and isolation measurement calibration (Network analyzer only)
S111	1-Port measurement calibration at port 1 (Network analyzer only)
S221	1-Port measurement calibration at port 2 (Network analyzer only)
FUL2	Full 2-Port measurement calibration (Network analyzer only)
ONE2	One-path 2-Port measurement calibration (Network analyzer only)
IMP	Calibration of the impedance analyzer mode. (Impedance analyzer only)

¹ Error correction will be turned off and all the coefficients in the array for error correction can no longer be used.

■ Query Response

C-2 Commands in Entry Block C (*C included)

{NONE|RESP|RAI|S111|S221|FUL2|ONE2|IMP} <new line><^END>

CALK□{APC7|APC35|N50|N75|USED}

Selects one of the default calibration kits available for different connector types. (Network and impedance analyzers only) (CAL KIT:7mm, 3.5mm, N 50 Ω, N 75 Ω, or USER KIT under **Cal**)

Parameter	Description
APC7	7 mm
APC35	3.5 mm
N50	Type-N 50 Ω
N75	Type-N 75 Ω
USED	User-defined

■ Query Response

{APC7|APC35|N50|N75|USED} <new line><^END>

CALS□<numeric>

Provides the tabular listing of the standard definitions. (Network and impedance analyzers only) (STD NO.1 to STD NO.8 under **Copy**); No query

Parameter	Range	Unit
<numeric>	1 to 8	

CBRI□<numeric>[PCT]

Adjusts the brightness of the color being modified. (**BRIGHTNESS** under **Display**)

Parameter	Range	Unit
<numeric>	0 to 100	%

■ Query Response

{numeric} <new line><^END>

CENT□<numeric>[HZ|DBM]

Defines the center value of the sweep range, or the center value of the segment to be edited in the list sweep table. ((Center), or CENTER under (Sweep))

Parameter	Range	Unit
<numeric>	0 to 510000000	Hz (frequency)
	10 to 510000000 (Network and impedance analyzers, when editing a list sweep table)	Hz (frequency)
	-50 to +15 (Network and impedance analyzers)	dBm (power)

■ Query Response

{numeric} <new line><^END>

CHAD□<string>

Changes the current directory on a DOS-formatted disk. (Specify a directory name you wish to change to) (CHANGE DIRECTORY under (Save); No query)

Parameter	Description
<string>	Directory path

CHAN{1|2}

Selects channel 1 or 2 as the active channel. ((Chan 1) or (Chan 2))

■ Query Response

{0|1} <new line><^END>

CIN

Set the port C, a 24-bit I/O port, as the input port.

CIRF □ {RI|LIN|LOG|RX|GB|SWR}

Selects format to readout the value of a Smith, polar, or admittance chart using markers. (Network and impedance analyzers only) (REAL IMAG, LIN MAG PHASE, LOG MAG PHASE, R+jX, G+jB, SWR PHASE under **Utility**)

Parameter	Description
RI	Real and imaginary form
LIN	Linear magnitude and phase form
LOG	Log magnitude and phase form
RX	Complex impedance form (R+jX)
GB	Complex admittance form (G+jB)
SWR	SWR and phase form

■ Query Response

{RI|LIN|LOG|RX|GB|SWR} <new line><^END>

CLAD

Completes the class assignment and stores it. (Network and impedance analyzers only) (CLASS DONE (SPE'D) under **Cal**); No query)

CLASIMP {A|B|C}

Selects and acquires the impedance calibration classes. (CALIBRATION OPEN, SHORT, or LOAD under **Cal**), respectively; No query; Impedance analyzer only)

The order in which you acquire the OPEN, SHORT, and LOAD is changeable. You can suspend a calibration sequence and do a different operation, and then resume the calibration sequence.

CLASS11{A|B|C}

Selects port 1 (S11) calibration standard class: S11A (open), S11B (short), or S11C (load). (Network analyzer only) ([S11] : OPEN, SHORT, LOAD under Cal); No query)

CLASS22{A|B|C}

Selects port 2 (S22) calibration standard class: S22A (open), S22B (short), or S22C (load), and starts calibration. (Network analyzer only) ([S22] : OPEN, SHORT, LOAD under Cal); No query)

CLEL

Clears the entire list. (CLEAR LIST under Sweep); No query)

CLES

Provides the same function as *CLS command. (No query)

***CLS**

Clears the error queues, the Status Byte register, the Operational Status register, the Standard Event Status register, and the Event Status register B (Instrument Event Status register). (No query)

CLOSE

Returns a file, which has been read/write-enabled using the ROPEN command or WOPEN command, to access-disabled status. If this command is executed before reading process using the READ? command completes, an error occurs.

Generally, this command is used in combination with the ROPEN command and READ? command or the WOPEN command and the WRITE command, as shown in Figure R-2. (No query)

CNTS□<numeric>[HZ|DBM]

Changes the step size for the center frequency function. (CENTER STEP SIZE under Center)

Parameter	Range	Unit
<numeric>	0.001 to 510000000 0.001 to 65	Hz dBm

■ Query Response

{numeric} <new line><^END>

CNTSAUTO□{OFF|ON|0|1}

Sets CENTER step policy. (STEP SIZE AUTO man under Center)

Parameter	Description
OFF or 0	Linear step
ON or 1	1-2-5 step

■ Query Response

{0|1} <new line><^END>

COLO□<parameter>

Specifies the display element to change color. (CH1 DATA, CH1 MEM LIMIT LN, CH2 DATA, CH2 MEM LIMIT LN, GRATICULE, IBASIC, PEN 1, PEN 2, PEN 3, PEN 4, PEN 5, PEN 6, TEXT, WARNING under Display)

COLO□<parameter>

Parameter	Description
CH1D	Channel 1 data trace
CH1M	Channel 1 memory and limit lines
CH2D	Channel 2 data trace
CH2M	Channel 2 memory and limit lines
GRAT	Graticule and a portion of softkey text
WARN	Warning annotation
TEXT	All the non-data text
IBT	Text on the BASIC screen
PEN1	Pen 1
PEN2	Pen 2
PEN3	Pen 3
PEN4	Pen 4
PEN5	Pen 5
PEN6	Pen 6

■ Query Response

{CH1D|CH1M|CH2D|CH2M|WARN|TEXT|GRAT|IBT|PEN1|PEN2|PEN3|PEN4|PEN5|PEN6}
<new line><^END>

□ Query Response

{*numeric (hue)*}, {*numeric (sat)*}, {*numeric (lum)*} <new line><^END>

COLOR□<numeric>[PCT]

Adjusts the degree of whiteness of the color being modified. (COLOR under Display)

Parameter	Range	Unit
<numeric>	0 to 100	%

■ Query Response

{*numeric*} <new line><^END>

COMC{A|B|C}

Measures the standards for the fixture compensation. (COMPEN OPEN, SHORT, or LOAD under Cal); No query; Impedance analyzer only)

Parameter	Description
A	Measures OPEN.
B	Measures SHORT.
C	Measures LOAD.

COMCDAT{A|B|C}□□{OFF|ON|0|1}

Sets the OPEN, SHORT, and LOAD fixture compensation ON or OFF. (OPEN ON off, SHORT ON off, or LOAD ON off under Cal); Impedance analyzer only)

Parameter	Description
A	Uses OPEN compensation data.
B	Uses SHORT compensation data
C	Uses LOAD compensation data
ON or 1	Turns on the selected data.
OFF or 0	Turns off the selected data.

- Query Response

{1|0} <new line><^END>

COMKDONE

Complete modifying the fixture compensation kit. (KIT DONE (MODIFIED) under Cal)
COMPEN KIT [USER] MODIFY [USER]; Impedance analyzer only)

COMP

Call the fixture compensation menu. You need send this command before sending COMC.
(COMPEN MENU under (Cal) FIXTURE COMPEN ; No query; Impedance analyzer only)

COMS

Displays the fixture compensation definition on the display. (COMPEN KIT DEFINITION under (Copy); No query; Impedance analyzer only)

COMSDONE

Complete defining the standard for the fixture compensation kit. (STD DONE (DEFINED) under (Cal) COMPEN KIT [USER] MODIFY [USER] ; Impedance analyzer only)

CONT

Triggers sweep automatically and continuously and the trace is updated with each sweep.
(CONTINUOUS under (Trig))

■ Query Response

{0|1} <new line><^END>

CONV□<parameter>

Selects the measurement data conversion setting (impedance, admittance, or multiple phase).
(Network analyzer only) (OFF, Z:Ref1, Z:Trans, Y:Ref1, Y:Trans, 1/S, 4xPHASE, 8xPHASE, 16xPHASE under (Meas))

Parameter	Description
OFF	Conversion OFF
ZREF	Z: reflection
ZTRA	Z: transmission
YREF	Y: reflection
YTRA	Y: transmission
ONEDS	Reciprocal (1/S)
MP4	Multiply phase by 4
MP8	Multiply phase by 8
MP16	Multiply phase by 16

■ Query Response

{OFF|ZREF|ZTRA|YREF|YTRA|ONEDS|MP4|MP8|MP16} <new line><^END>

COPA

Aborts a print in progress. (COPY ABORT under Copy); No query)

COPT□{OFF|ON|0|1}

Turns printing time and date (the time stamp function) ON or OFF. (COPY TIME ON off under Copy)

Parameter	Description
OFF or 0	Time stamp function OFF
ON or 1	Time stamp function ON

■ Query Response

{0|1} <new line><^END>

CORR□{OFF|ON|0|1}

Turns error correction ON or OFF. (Network and impedance analyzers only)
(CORRECTION ON off under Cal), This softkey is Network analyzer only)

Parameter	Description
OFF or 0	Error correction OFF
ON or 1	Error correction ON

■ Query Response

{0|1} <new line><^END>

COUC□{OFF|ON|0|1}

Sets the channel coupling of sweep parameter values. (Between network or between impedance analyzers only) (COUPLED CH ON off under Sweep)

Parameter	Description
OFF or 0	Channel coupling OFF
ON or 1	Channel coupling ON

■ Query Response

{0|1} <new line><^END>

COU

Sets the port C, a 24-bit I/O port, as the output port.

CRED□<string>

Create a new directory in a DOS format disk. (CREATE DIRECTORY under Save; No query)

Parameter	Description
<string>	Up to 8 characters for directory name (and up to 3 characters for extension)

CWFREQ□<numeric>[HZ]

Sets the frequency for power sweep. (Network and impedance analyzers only) (CWFREQ under Source)

Parameter	Range	Unit
<numeric>	0 to 510000000 (0.001 resolution)	Hz

■ Query Response

{numeric} <new line><^END>

CWD?

Returns the name of the current directory. (Query only)

■ Query Response

{*string*} <new line><^END>

D

Commands in Entry Block D

DATAOVAL□<numeric>

Defines the imaginary part of the offset value when using the Smith, Polar, and admittance chart format. (**AUX OFFSET** under **Display**)

Parameter	Range	Unit
<numeric>	-500000 to 500000	

■ Query Response

{numeric} <new line><^END>

DATGAIN□<numeric>

Defines the gain value of the data math function. (**GAIN** under **Display**)

Parameter	Range	Unit
<numeric>	-100 to 100 (0 excluded)	

■ Query Response

{numeric} <new line><^END>

DATMEM

Stores the current active measurement data in the memory trace of the active channel. Also use this command to store data in the data trace to the memory trace. (**DATA—MEMORY** under **Display**); No query)

DATOVAl □ <numeric>

Defines the offset value. When using Smith, Polar, and admittance chart format, this command defines the real part of the offset value. (**OFFSET** under **Display**)

Parameter	Range	Unit
<numeric>	-500000 to 500000	

■ Query Response

{numeric} <new line><^END>

DATOVE

Copy the current data trace to an overlay trace on the LCD. (**DATA→OVERLAY** under **Display**); No query)

DAYMYEAR

Changes the displayed date to the “day:month:year” format. (**DayMonYear** under **System**)

■ Query Response

{0|1} <new line><^END>

Parameter	Description
0	“month:day:year” format
1	“day:month:year” format

DCCTL □ {VOLT|CURR}

Sets the DC OUT port to control either voltage or current.

Parameter	Description
VOLT	The DC OUT port controls voltage (voltage control mode).
CURR	The DC OUT port controls current (current control mode).

DCI □ <numeric> [A]

Sets DC current for the DC OUT port. When editing a segment in a list sweep table, sets DC current for the segment currently being edited.

Parameter	Range	Unit
<numeric>	-0.000002(=20 μ) to 0.1 0.000002(=20 μ) to 0.1 (20 μ A resolution)	A

DCO □ {OFF|ON|0|1}

Turns the DC OUT port ON or OFF.

Parameter	Description
OFF or 0	The DC OUT port is turned OFF.
ON or 1	The DC OUT port is turned ON.

■ Query Response

{0|1} <new line><^END>

DCV □ <numeric> [V]

Sets DC voltage for the DC OUT port. When editing a segment in a list sweep table, sets DC voltage for the segment currently being edited.

Parameter	Range	Unit
<numeric>	-40 to 40 (1mV resolution)	V

DEFC

Returns all the color settings back to the factory-set default values. (DEFAULT COLORS under **Display**); No query)

DEFEC{R1|C1|L1|C0}␣<numeric>

Defines the specified equivalent circuit parameter for simulation. (PARAMETER R1, C1, L1, C0 under `[Display]`; Impedance analyzer only)

Parameter	Description
R1	Parameter R ₁
C1	Parameter C ₁
L1	Parameter L ₁
C0	Parameter C ₀

Parameter	Range	Unit
<numeric>	-1×10 ¹⁸ to 1×10 ¹⁸	F(C0,C1) H(L1) OHM(R1)

■ Query Response

<numeric> <new line><^END>

DEFGO

Returns the gain and offset values back to the default values (gain=1, offset=0). (DEFAULT GAIN & OFS under `[Display]`; No query)

DEFS␣{1-8}

Defines the number of the calibration standards to be modified. (Network and impedance analyzers only) (DEFINE STANDARD under `[Cal]`; No query)

Parameter	Description
1	Standard no. 1 (SHORT)
2	Standard no. 2 (OPEN)
3	Standard no. 3 (LOAD)
4	Standard no. 4 (DEL/THRU)
5	Standard no. 5 (LOAD)
6	Standard no. 6 (LOAD)
7	Standard no. 7 (SHORT)
8	Standard no. 8 (OPEN)

■ Query Response

{ STAN{1-8} } <new line><^END>

DEFSLOAD{R|L} □ <numeric>

Defines the LOAD standard by entering resistance and reactance value.

(LOAD: RESIST.(R), INDUCT.(L) under **Cal** CAL KIT [] . Impedance analyzer only)

Parameter	Description
R	Resistance value of the LOAD fixture compensation standard.
L	Inductance value of the LOAD fixture compensation standard.

Parameter	Range	Unit
<numeric>	-1×10 ⁶ to 1×10 ⁶	Ω (R)
<numeric>	-1×10 ⁶ to 1×10 ⁶	H (L)

■ Query Response

{numeric} <new line><^END>

DEFSOPEN{G|C} □ <numeric>

Defines the OPEN standard by entering conductance and capacitance value.

(OPEN: CONDUCT.(G), CAP.(C) under **Cal** CAL KIT [] . Impedance analyzer only)

Parameter	Description
G	Conductance value of the OPEN fixture compensation standard.
C	Capacitance value of the OPEN fixture compensation standard.

Parameter	Range	Unit
<numeric>	-1×10 ⁶ to 1×10 ⁶	S (G)
<numeric>	-1×10 ⁶ to 1×10 ⁶	fF (C)

■ Query Response

{numeric} <new line><^END>

DEFSSHOR {R|L} □ <numeric>

Defines the SHORT calibration standard by entering resistance and inductance value.
(SHORT: RESIST.(R), INDUCT.(L) under **Cal** CAL KIT []). Impedance analyzer only)

Parameter	Description
R	Resistance value of the SHORT fixture compensation standard.
L	Inductance value of the SHORT fixture compensation standard.

Parameter	Range	Unit
<numeric>	-1×10 ⁶ to 1×10 ⁶	Ω (R)
<numeric>	-1×10 ⁶ to 1×10 ⁶	H (L) (L)

■ Query Response

{numeric} <new line><^END>

DET □ {POS|NEG|SAM}

Selects the detection mode for the active channel. (Spectrum analyzer only) (POS PEAK, NEG PEAK, SAMPLE under **Meas**)

Parameter	Description
POS	Positive Detection
NEG	Negative Detection
SAM	Sample Detection

■ Query Response

{POS|NEG|SAM} <new line><^END>

DHOLD□□{OFF|MAX|MIN}

Selects the data hold operation. When the format is changed, the value held is initiated.

(HOLD: OFF, MAX, MIN under **Display**)

Parameter	Description
OFF	Data hold operation is turned off
MAX	Maximum data hold
MIN	Minimum data hold

■ Query Response

{OFF|MAX|MIN} <new line><^END>

DIN

Sets the port D, a 24-bit I/O port, as the input port.

DISA□{ALLI|HIHB|ALLB|BASS}

Selects the display allocation mode. (DISP ALLOC [ALL INST] under **Display**)

Parameter	Description
ALLI	All instrument
HIHB	Half instrument and half HP Instrument BASIC
ALLB	All HP Instrument BASIC
BASS	HP Instrument BASIC status

■ Query Response

{ALLI|HIHB|ALLB|BASS} <new line><^END>

DISECIRC {OFF|ON|0|1}

Displays the equivalent circuit models. (SELECT EQV CKT [A] under **Display**); Impedance analyzer only)

Parameter	Description
OFF or 0	Turns off the equivalent circuit parameter display.
ON or 1	Turns on the equivalent circuit parameter display.

■ Query Response

{0|1} <new line><^END>

DISECPARA {OFF|ON|0|1}

Displays the equivalent circuit parameters. (DISP EQV PARM [ON] or [OFF] under **Display**); Impedance analyzer only)

Parameter	Description
OFF or 0	Turns off the equivalent circuit parameter display.
ON or 1	Turns on the equivalent circuit parameter display.

■ Query Response

{0|1} <new line><^END>

DISF□{DOS|LIF}

Selects the disk format (LIF or DOS) to be used when initializing a new disk. (FORMAT [] under **Save**); No equivalent SCPI command)

Parameter	Description
DOS	DOS format
LIF	Logical Interchange format

■ Query Response

{DOS|LIF} <new line><^END>

DISL

Displays the list sweep table on the display. (DISPLAY LIST under [Copy](#)); No query)

DISLLIST

Displays the limit testing table on the display. (DISPLAY LIST under [Copy](#)); No query)

DISMAMP□{UL|MD}

Selects the amplitude format to display the limit testing table to list on the screen. (DISP MODE: UPR & LWR, MID & DLT under [Copy](#)); No equivalent SCPI command)

Parameter	Description
UL	Upper and lower format
MD	Middle and delta format

■ Query Response

{UL|MD} <new line><^END>

DISMPRM□{STSP|CTSP}

Selects the sweep parameter range format to display the list sweep table on the screen. (DISP MODE: ST & SP, CTR & SPAN under [Copy](#))

Parameter	Description
STSP	Start and stop format
CTSP	Center and span format

■ Query Response

{STSP|CTSP} <new line><^END>

DISP□{DATA|MEMO|DATM}

Selects the display trace type. (DISPLAY: DATA, MEMORY, DATA and MEMORY under **Display**)

Parameter	Description
DATA	Current data trace
MEMO	Memory trace
DATM	Current data and memory traces

■ Query Response

{DATA|MEMO|DATM} <new line><^END>

DMKR□{ON|FIX|TRAC|OFF}

Displays the Δ marker (ON, FIX, TRAC) at the point of the marker and the marker mode changes to the Δ mode. Erases (OFF) the Δ marker and the Δ mode is turned off. (**DMKR**, **FIXED DMKR**, **TRACKING DMKR**, **DMODE OFF** under **Marker**)

Parameter	Description
ON	Puts the Δ marker on a current position of the marker.
FIX	Sets a user-specified fixed reference marker.
TRAC	Puts a Δ marker at the present active marker position and turns on the tracking Δ marker.
OFF	Turns off the Δ mode.

■ Query Response

{ON|FIX|TRAC|OFF} <new line><^END>

DMKRAUV□<numeric>

Sets the auxiliary amplitude value of the fixed Δ marker. This command is used with a polar, Smith, or admittance chart. (Network and impedance analyzers only) (**DMKR AUX VALUE** under **Marker**)

Parameter	Range	Unit
<numeric>	-1000000000 to 1000000000	

■ Query Response

{numeric} <new line><^END>

DMKRPRM \square <numeric> [HZ|DBM]

Sets the sweep parameter value of the Δ marker. (**DMKR SWP PRM** under **Marker**)

Parameter	Range	Unit
<numeric>	Start value to stop value	Hz (frequency) dBm (power)

■ Query Response

{numeric} <new line><^END>

DMKRVAL \square <numeric>

Sets the amplitude value of the fixed Δ marker. (**DMKR VALUE** under **Marker**)

Parameter	Range	Format
<numeric>	-1000000000 to 1000000000	

■ Query Response

{numeric} <new line><^END>

DONE

Completes the measurement of the selected response/isolation calibration. (Network and impedance analyzers only) (**DONE: RESPONSE** under **Cal**). When Type-N calkits or user calkit, **DONE: OPEN** **DONE: SHORT** under **Cal**. No query)

DOUT

Sets the port D, a 24-bit I/O port, as the output port.

DSKEY

Disables the front panel keys and the rotary knob. To enable the keys and knob again, send the ENKEY command. (No query)

DUAC \square {OFF|ON|0|1}

Selects the display of both measurement channels or the active channel only.
(DUAL CHAN ON off under Display)

Parameter	Description
OFF or 0	Active channel only
ON or 1	Both channels

■ Query Response

{0|1} <new line><^END>

Commands in Entry Block E (*E included)

EDITDONE

Completes editing the sweep list. (`LIST DONE` under `Sweep`); No query

EDITLIML

Begins editing the limit line table. (`EDIT LIMIT LINE` under `System`); No query

EDITLIST

Begins editing the frequency sweep list. (`EDIT LIST` under `Sweep`); No query

ELED \square *<numeric>* [`S`|`MS`|`US`|`NS`|`PS`|`FS`]

Adjusts the electrical delay to balance the phase of the DUT. (Network analyzer only)

(`ELECTRICAL DELAY` under `Scale Ref`)

Parameter	Range	Unit
<i><numeric></i>	-0.01 to 0.01 (1×10^{-12} resolution)	sec

■ Query Response

{numeric} <new line><^END>

ENKEY

Re-enables the front panel keys and the rotary knob that have been disabled by the DSKEY command. (No query)

EQUCLCIR{A|B|C|D|E}

Selects the equivalent circuit. (`SELECT EQV CKT []` under `Display`). Impedance analyzer only)

Parameter	Description
CIRA	For coils with high core loss.
CIRB	For coils and resistance.
CIRC	For high-value resistors.
CIRD	For capacitors.
CIRE	For resonators.

■ Query Response

CIR{A|B|C|D|E}<new line><^END>

ESB?

Outputs the Event Status register B (Instrument Event Status register) value. (Query only)

■ Query Response

{*numeric*} <new line><^END>

*ESEL<*numeric*>

Sets the enable bits of the Standard Event Status Register.

Parameter	Description
< <i>numeric</i> >	0 to 255 (decimal expression of enable bits of the operation status register)

■ Query Response

{*numeric*} <new line><^END>

ESNB <numeric>

Enables the bits of Event Status register B (Instrument Event Status register).

Parameter	Range	Unit
<numeric>	Decimal expression of the contents of the register, 0 to 65535 (=2 ¹⁶ -1)	

■ Query Response

{numeric} <new line><^END>

*ESR?

Returns the contents of the Standard Event Status Register. (Query only)

■ Query Response

{numeric} <new line><^END>

EXPP {OFF|ON|0|1}

Turns on and off the expanded phase display (displaying phase in -180° to 180° without wrapping around). (EXP PHASE on OFF under **Format**); Impedance analyzer only)

Parameter	Description
OFF or 0	Turns off the expanded phase display.
ON or 1	Turns on the expanded phase display.

■ Query Response

{0|1} <new line><^END>

Commands in Entry Block F

FILC □ *<string1>*, *<string2>*, *<string3>*, *<string4>*

Copies files. (COPY FILE under Save); No query

Parameter	Description
<i><string1></i>	Source file name
<i><string2></i>	Source device name (“DISK” or “MEMORY”) ¹
<i><string3></i>	Destination file name
<i><string4></i>	Destination device name (“DISK” or “MEMORY”)

¹ “DISK” for the built-in flexible disk drive; “MEMORY” for the RAM disk memory.

FIXE □ *<numeric>*

Sets the electrical length of the fixture. (DEFINE EXTENSION under Meas; Impedance analyzer only.)

Parameter	Range	Unit
<i><numeric></i>	-0.01 to 0.01 (1×10^{-12} resolution)	m

■ Query Response

{*numeric*} <new line> <^END>

FIXKDONE

Terminates the user fixture setting. (DONE under Meas; No query; Impedance analyzer only.)

FIXT □ { **NONE** | **HP 16191** | **HP 16192** | **HP 16193** | **HP 16194** | **USED** }

Specifies the fixture in use in order to select which electrical length (recorded in the analyzer) is to be used. (**FIXTURE:NONE** , **HP16191** , **HP16192** , **HP16193** , **HP16194** , **USED** under **Meas** **SELECT FIXTURE** ; Impedance analyzer only.)

■ Query Response

{ **NONE** | **HP16191** | **HP16192** | **HP16193** | **HP16194** | **USED** } <new line> <^END>

FMT □ <parameter>

Selects the display format. (**FORMAT: LOG MAG** , **PHASE** , **DELAY** , **SMITH [Re Im]** , **POLAR [Re Im]** , **LIN MAG** , **SWR** , **FORMAT: REAL** , **IMAGINARY** , **EXPANDED PHASE** , **ADMITTANCE [Re Im]** , **FORMAT: SPECTRUM** , **NOISE** , **LIN Y-AXIS** , **LOG Y-AXIS** , **COPLEX PLANE** under **Format**)

Parameter	Description
LOGM	Log magnitude format (Network analyzer only)
PHAS	Phase format (Network analyzer only)
DELA	Delay format (Network analyzer only)
LINM	Linear magnitude format (Network analyzer only)
SWR	SWR format (Network analyzer only)
REAL	Real format (Network analyzer only)
IMAG	Imaginary format (Network analyzer only)
SMITH	Smith chart format (Network and impedance analyzers only)
POLA	Polar chart format (Network and impedance analyzers only)
ADMIT	Admittance Smith chart (Network and impedance analyzers only)
SPECT	Spectrum measurement (Spectrum analyzer only)
NOISE	Noise level measurement (Spectrum analyzer only)
LINY	Linear Y-axis measurement (Impedance analyzer only)
LOGY	Log Y-axis measurement (Impedance analyzer only)
COMP	Complex plane measurement (Impedance analyzer only)
EXPP	Expanded phase format (Network analyzer only)

■ Query Response

{ **LOGM** | **PHAS** | **DELA** | **LINM** | **SWR** | **REAL** | **IMAG** | **SMITH** | **POLA** | **EXPP** | **ADMIT** | **SPECT** | **NOISE** | **LINY** | <new line> <^END>

FNAME?□<*numeric*>

Returns the file name corresponding to a specified number in the current directory. To each file, a number is assigned from 1 to “the number of the files” in alphabetical order. Use the FNUM? command to verify the number of the files in the current directory. (Query only)

Parameter	Description	Range
< <i>numeric</i> >	Specified file No.	1 to “the number of the files in the current directory”

■ Query Response

{*string*} <new line><^END>

FNUM?

Returns the number of the files in the current directory. (Query only)

■ Query Response

{*numeric*} <new line><^END>

FORM2

Sets the IEEE 32-bit floating point format to transfer trace data via GPIB. (No query)

FORM3

Sets the IEEE 64-bit floating point format to transfer the trace data via GPIB. (No query)

FORM4

Sets the ASCII transfer format to transfer the trace data via GPIB. (No query)

FORM5

Sets MS-DOS format to transfer the trace data via GPIB. (No query)

FREO

Blanks the displayed frequency notation for security purposes. Frequency notation cannot be restored except by sending the :SYSTEM:PRESet or *RST command, or by turning the power OFF and ON. (FREQUENCY BLANK under **Display**)

■ Query Response

{0|1} <new line><^END>

FSIZE?□<string>

Returns the size of a specified file in bytes. If the file does not exist, this command returns -1. (Query only)

Parameter	Description
<string>	File name of up to 12 characters including its extension (for the LIF format, up to 10 characters)

■ Query Response

{numeric} <new line><^END>

FULS

Sets the SPAN to the maximum range. This command is valid for all sweeping modes except list sweep. (FULL SPAN under **Span**); No query

FWDI

Measures S_{21} isolation. (Network analyzer only) (`FWD ISOL'N ISOL'N STD` under `Cal`); No query)

FWDM

Measures S_{11} load match. (Network analyzer only) (`FWD. MATCH THRU` under `Cal`); No query)

FWDT

Measures S_{21} frequency response. (Network analyzer only) (`FWD. TRANS. THRU` under `Cal`); No query)

Commands in Entry Block G

GATCTL □ {LEV|EDG}

Specifies the gate trigger mode. (Spectrum analyzer only) (Option 1D6 only)
 (GATE CTL: LEVEL, EDGE under **Trigger**)

Parameter	Description
LEV	Level gate trigger mode
EDG	Edge gate trigger mode

■ Query Response

{LEV|EDG} <new line><^END>

GATDLY □ <numeric> [S]

Sets the gate delay. (Spectrum analyzer only) (Option 1D6 only) (GATE DELAY under **Trigger**)

Parameter	Range	Unit
<numeric>	0.0000008 (=0.8 μ) to 3.2	sec

■ Query Response

{numeric} <new line><^END>

GATLEN \square <numeric> [S]

Sets the gate length. (Spectrum analyzer only) (Option 1D6 only) (GATE LENGTH under Trigger)

Parameter	Range	Unit
<numeric>	0.000002 (=2 μ) to 3.2	sec

■ Query Response

{numeric} <new line><^END>

GCLEAR

Erases the image of data trace displayed using DATOVE command. (CLEAR GRAPHICS under Display); No query)

GRODAPER \square <numeric> [PCT]

Sets the aperture for the group delay measurement as a percentage of the span. (Network analyzer only) (GROUP DELY APERTURE under Bw/Avg)

Parameter	Range	Unit
<numeric>	0.25 to 20 (of span) (simple command)	%

■ Query Response

{numeric} <new line><^END>

Commands in Entry Block H

HOLD

Freezes the data trace on the display. the analyzer stops sweeping and taking data.

(`SWEEP: HOLD` under `Trigger`)

■ Query Response

{0|1} <new line><^END>

Parameter	Description
0	Sweeping (not hold mode)
1	Hold mode

Commands in Entry Block I (*I included)

*IDN?

Returns the analyzer's ID.

■ Query Response

{*Agilent Technologies*} {*4395A*} {*serial no.*} {*firmware rev.*} <new line><^END>

INID

Initializes the disk in the flexible disk drive or the RAM disk memory. (**INITIALIZE** under **Save**); No query)

Floppy disks can be initialized in the 2HD format only.

INP8IO?

Inputs data from the 4-bit parallel input to the analyzer, and outputs the data to a controller. (Query only)

■ Query Response

{*numeric*} <new line><^END>

INPT?

Returns the pulse input status for the INPUT1, a 24-bit I/O port. (Query only)

■ Query Response

{0|1} <new line><^END>

Parameter	Description
0	No pulse input
1	Pulse input ¹

¹ Once 1 is returned, the value is reset, 0 will be returned until there is another pulse input.

INPUCALC{1-12} □ <numeric (1)>, <numeric (2)>, ... , <numeric (n)>

Stores the measurement calibration error coefficient set of real/imaginary pairs input via GPIB into the analyzer's memory. The command definition changes to INPUCALC{1-3} when used in the impedance analyzer. (Network and impedance analyzers only; No query)

Parameter	Description
<numeric>	Complex number (Data format: real, imaginary)

INPUCALK □ <block>

Stores the calibration kit data transmitted by the OUTPCALK? command. (Network and impedance analyzers only) (No query)

Parameter	Description
<block>	Block data (Data format: 4395A internal format (714 bytes of binary data))

INPUCOMC{1|2|3} □ □ <numeric (1)>, <numeric (2)>, ... , <numeric (n)>

Inputs data into the fixture compensation coefficient arrays. (No query; Impedance analyzer only.)

The analyzer handles a reflection coefficient data for the intermediate processing. Thus, the fixture compensation is performed for the reflection coefficient as follows:

$$\Gamma = \frac{\Gamma_M - A}{B \times (\Gamma_M - A) + C}$$

Where,

A , B , and C Fixture compensation coefficients. (complex)

Γ_M Measured reflection data. (converted from V and I.)

Γ Corrected reflection data.

By using this command, you can change the contents of the fixture compensation coefficient arrays.

Parameter	Description
1	coefficient A
2	coefficient B
3	coefficient C
<numeric>	Complex number (Data format: real, imaginary)

INPUDATA □ <numeric (1)>, <numeric (2)>, ... , <numeric (n)>

Inputs the error corrected data. (No query)

Parameter	Description
<numeric>	Complex number (Data format: real, imaginary) for the Network analyzer Real number for the Spectrum analyzer

INPUDTRC □ <numeric (1)>, <numeric (2)>, ... , <numeric (n)>

Inputs data to DATA TRACE memory. (No query)

Parameter	Description
<numeric>	Complex number (Data format: real, imaginary) for the Network analyzer Real number for the Spectrum analyzer

INPURAW{1-4} □ <numeric (1)>, <numeric (2)>, ... , <numeric (n)>

Inputs raw data. The command definition changes to INPURAW{1} when used in the impedance analyzer and spectrum analyzer. (No query)

Parameter	Description
<numeric>	Complex number (Data format: real, imaginary) for the Network analyzer Real number for the Spectrum analyzer

INTE □ <numeric> [PCT]

Sets the display intensity as a percent of the brightest setting. (**INTENSITY** under **Display**)

Parameter	Range	Unit
<value>	0 to 100 (simple command)	%

- Query Response

{numeric} <new line>< ^END>

ISOD

Completes isolation calibration. The error coefficients are calculated and stored. (Network analyzer only) (`ISOLATION DONE` under `Cal`); No query)

ISOL

Starts the isolation calibration. (Network analyzer only) (`ISOLATION` under `Cal`); No query)

Commands in Entry Block K

KEY<numeric>

Sends the key code for a key or a softkey on the front panel. This is equivalent to actually pressing a key. See Figure K-1 for key codes.

Parameter	Description
<numeric>	0 to 52

■ Query Response

{numeric} <new line><^END>

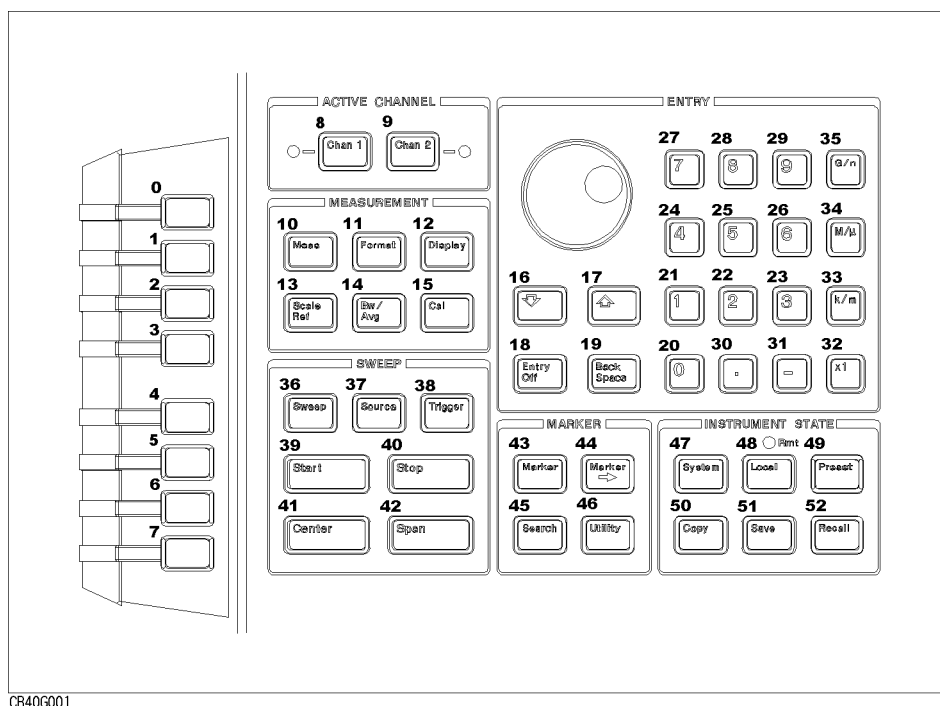

Figure K-1. Key Codes

KITD

Completes the procedure to define user cal kit. (Network analyzer only)
 (KIT DONE (MODIFIED) under **Cal**); No query)

Commands in Entry Block L

LABECOMK□<string>

Modifies the label of user defined fixture compensation kit. (Impedance analyzer only)
(**LABEL KIT** under **Ca**); No query)

Parameter	Description
<string>	Up to 8 characters.

■ Query Response

{string} <new line><^END>

LABEFIX□<string>

Modifies the label of user defined test fixture. (**LABEL FIXTURE** under **Meas** **FIXTURE []**;
Impedance analyzer only.)

Parameter	Description
<string>	Up to ten characters.

■ Query Response

<string><new line><^END>

LABEFDW{T|M}□<string>

Defines the label for the forward transmission (THRU) or the forward match (THRU) calibration. (Network analyzer only) (LABEL: FWD. TRANS., FWD. MATCH under Cal); No query)

Parameter	Description
<string>	Up to eight characters.

■ Query Response

{string} <new line><^END>

LABEIMP{A|B|C}□<string>

Defines the label for the first class, second class, or the third class required for an impedance measurement calibration. (Impedance analyzer only) (LABEL CLASS under Cal); No query)

Parameter	Description
<string>	Up to eight characters.

■ Query Response

{string} <new line><^END>

LABERES{P|I}□<string>

Defines the label for the response, or the response and isolation calibration. (Network analyzer only) (RESPONSE, RESPONSE & ISOL'N under Cal); No query)

Parameter	Description
<string>	Up to eight characters.

■ Query Response

{string} <new line><^END>

LABEREV{T|M}␣<string>

Defines the label for reverse transmission (THRU) or the reverse match (THRU) calibration. (Network analyzer only) (REV.TRANS., REV.MATCH under Cal); No query)

Parameter	Description
<string>	Up to eight characters.

■ Query Response

{string} <new line><^END>

LABES11{A|B|C}␣<string>

Defines the label for the first class, the second class, or the third class required for an S₁₁ 1-port calibration. (Network analyzer only) (LABEL: S11A, S11B, S11C under Cal); No query)

Parameter	Description
<string>	Up to eight characters.

■ Query Response

{string} <new line><^END>

LABES22{A|B|C}␣<string>

Defines the label for the first class, the second class, or the third class required for an S₂₂ 1-port calibration. (Network analyzer only) (LABEL: S22A, S22B, S22C under Cal); No query)

Parameter	Description
<string>	Up to eight characters.

■ Query Response

{string} <new line><^END>

LABK \square <string>

Defines a label for a new calibration kit. (Network and impedance analyzers only)
(**LABEL KIT** under **Cal**); No query)

Parameter	Description
<string>	Up to eight characters.

■ Query Response

{string} <new line><^END>

LABS \square <string>

Defines a label for the standard. (Network and impedance analyzers only) (**LABEL STD** under **Cal**); No query)

Parameter	Description
<string>	Up to ten characters.

■ Query Response

{string} <new line><^END>

LIMCLEL

Clears all segments in the limit line. (**CLEAR LIST YES** under **System**); No query)

LIMD \square <numeric>

Sets the limits an equal amount above and below a specified middle value, instead of setting upper and lower limits separately. (**DELTA LIMITS** under **System**)

This command is valid while editing a segment in a limit line table.

Parameter	Range	Unit
<numeric>	0 to 2000000000	

■ Query Response

{numeric} <new line><^END>

LIMEDONE

Completes editing the limit table. (**DONE** under **(System)**; No query)

LIMIAMPO□<numeric>

Adds or subtracts an offset in amplitude value. (**AMPLITUDE OFFSET** under **(System)**)

Parameter	Range	Unit
<numeric>	-1000000000 to 1000000000	

■ Query Response

{numeric} <new line><^END>

LIMILINE□{OFF|ON|0|1}

Sets limit lines ON or OFF. (**LIMIT LINE ON off** under **(System)**)

Parameter	Description
OFF or 0	Limit lines OFF
ON or 1	Limit lines ON

■ Query Response

{0|1} <new line><^END>

LIMIPRMO□<numeric>

Adds or subtracts an offset from the sweep parameter value. (**SWP PARAM OFFSET** under **(System)**)

Parameter	Range	Unit
<numeric>	-12×10^9 (= -1G) to $1. \times 10^9$ (=1G) (0.001 resolution)	

■ Query Response

{numeric} <new line><^END>

LIMITEST □ {OFF|ON|0|1}

Sets the limit testing ON or OFF. (LIMIT TEST ON off under (System))

This command uses the limit line currently set in the 4395A, regardless it is displayed or not.

Parameter	Description
OFF or 0	Limit testing OFF
ON or 1	Limit testing ON

■ Query Response

{*numeric*} <new line><^END>

LIML □ <*numeric*>

Sets the lower limit value for the segment. (LOWER LIMIT under (System))

This command is valid while editing a segment in a limit line table.

Parameter	Range	Unit
< <i>numeric</i> >	-1000000000 to 1000000000	

■ Query Response

{*numeric*} <new line><^END>

LIMM □ <*numeric*>

Sets the midpoint for delta limits. (MIDDLE VALUE under (System))

This command is valid while editing a segment in a limit line table.

Parameter	Range	Unit
< <i>numeric</i> >	-1000000000 to 1000000000	

■ Query Response

{*numeric*} <new line><^END>

LIMPRM \square $\langle numeric \rangle$ [HZ|DBM]

Sets the starting sweep parameter value of a segment, using entry block controls. (SWP PARAM under **System**)

This command is valid while editing a segment in a limit line table.

Parameter	Range	Unit
$\langle numeric \rangle$	-12×10^9 (= -1G) to $1. \times 10^9$ (=1G) (0.001 resolution)	

■ Query Response

$\{ numeric \}$ $\langle new\ line \rangle \langle \wedge END \rangle$

LIMSADD

Adds a new segment to the end of the limit list. (ADD under **System**); No query)

This command initiates the editing a segment in a limit line table.

LIMSDEL

Deletes a limit testing segment. (DELETE under **System**); No query)

LIMSDON

Terminates a limit line segment definition. (DONE under **System**); No query)

All the segments in a limit line are sorted based on the sweep parameters then stored in the build-in memory in the 4395A. Presetting the 4395A by PRES will not clear the limit line in the memory.

LIMSEDI□[<numeric>]

Specifies which limit segment in the table to edit. When you want to define or modify the values of the specified segment, you do not have to enter <numeric> (the segment number). (SEGMENT, EDIT under System)

This command initiates the editing a segment in a limit line table.

Parameter	Description
<numeric>	Segment number, 1 to 18.

■ Query Response

{numeric} <new line><^END>

LIMU□<numeric>

Sets the upper limit value for a limit testing segment. (UPPER LIMIT under System)

This command is valid while editing a segment in a limit line table.

Parameter	Range	Unit
<numeric>	-1000000000 to 1000000000	

■ Query Response

{numeric} <new line><^END>

LISDFBASE

Displays contents of the trace sorting based on the sweep parameter, when the sweeping mode is set to the frequency list sweep. This commands works exclusively with the command LISDOBASE.

Parameter	Description
OFF or 0	Displays contents of the trace at an even intervals sorting based on the order of acquisition.
ON or 1	Displays contents of the trace sorting based on the sweep parameter.

■ Query Response

{0|1} <new line><^END>

LISDOBASE

Displays contents of the trace at an even intervals sorting based on the order of acquisition, when the sweeping mode is set to the frequency list sweep. This commands works exclusively with the command LISDFBASE.

Parameter	Description
OFF or 0	Displays contents of the trace sorting based on the sweep parameter.
ON or 1	Displays contents of the trace at an even intervals sorting based on the order of acquisition.

■ Query Response

{0|1} <new line><^END>

LISV

Displays a tabular listing of all the measured data points and their current values. (LIST VALUES under **Copy**); No query)

LVCDDT[A|B|R]□<numeric>[DB]

Sets the level calibration data for the port R, A, or B (adds an offset value to the measured value). (Spectrum analyzer only) (LVL CAL DATA under **Cal**)

Parameter	Range	Unit
<numeric>	-10 to 10 (0.1 resolution)	dB

Commands in Entry Block M

MATH □ {DATA|DDVM|DMNM|DPLM}

Sets the trace math operation. (DATA MATH: DATA, DATA-MEM, DATA+MEM, DATA/MEM under DATA MATH [] under Display)

Parameter	Description
DATA	Turns OFF all data math functions.
DMNM	Subtracts the memory from the data.
DPLM	Adds the memory to the data.
DDVM	Divides the data by the memory.

■ Query Response

{DATA|DMNM|DPLM|DDVM} <new line><^END>

MAXDCI □ <numeric> [A]

Sets the upper limit of the current for the DC OUT port when it is in the voltage control mode. This command also defines the upper limit value for altered polarity for the specified value is regarded as an absolute value.

Parameter	Range	Unit
<numeric>	0.00001 (=100μ) to 0.1 (0 V< V _{DC} <25 V) 0.00001 (=100μ) to 0.02 (25 V< V _{DC} <40 V) (20μA resolution)	A

|V_{DC}| denotes the output voltage of the DC OUT port.

MAXDCV \square $\langle numeric \rangle$ [V]

Sets the upper limit of the voltage for the DC OUT port when it is in the current control mode. This command also defines the upper limit value for altered polarity for the specified value is regarded as an absolute value.

Parameter	Range	Unit
$\langle numeric \rangle$	0.01 to 40 (0 A $\langle I_{DC} $ \langle 20 mA) 0.01 to 25 (20 mA $\langle I_{DC} $ \langle 100 mA) (1mV resolution)	A

$|I_{DC}|$ denotes the output current of the DC OUT port.

MEAS \square $\langle parameter \rangle$

Selects the parameters or inputs to be measured. (NETWORK: A/R, B/R, R, A, B, Ref1: FWD S11 [A/R], Trans:FWD S21 [B/R], Trans:REV S12 [A/R], Ref1: REV S22 [B/R], SPECTRUM: S, R, A, B, IMPEDANCE: MAG(|Z|), PHASE(θ_Z), RESIST(R), REACT(X), ADMITTNCE:MAG(|Y|), PHASE(θ_Y), CONDUCT(G), SUSCEPT(B), REFL.COEF:MAX(| Γ |), PHASE(θ_Γ)}}, REAL(Γ_X), IMAG(Γ_Y), CAPCITNCE:PRL(Cp), SER(Cs), INDUCTNCE:PRL(Lp) SER(Ls), RESISTNCE:PRL(Rp), SER(Rs), D FACTOR(D), Q FACTOR(Q) under **Meas**)

MEASTAT \square {OFF|ON|0|1}

Calculates the mean, standard deviation, and peak-to-peak values in the portion of the displayed trace that is in the search range. (STATICS ON off under **Utility**)

Parameter	Description
OFF or 0	Does not display the statistical values
ON or 1	Displays the statistical values

■ Query Response

{0|1} <new line><^END>

MKR \square {OFF|ON|0|1}

Sets the marker to active (ON) or inactive (OFF). When the MKR is turned off, the marker, sub-marker, and Δ marker are tuned to be off. (**MKR**)

Parameter	Description
OFF or 0	Turns off the marker function.
ON or 1	Turns on the marker function.

■ Query Response

{0|1} <new line><^END>

MKRAMPO

Moves the limits so that they are centered an equal amount above and below the marker at the sweep parameter value. (MAKER→AMP.OFS. under System); No query)

MKRAUV?

Outputs the auxiliary amplitude value (value 2) of the measurement value at the marker position. See “Marker Readout” in Chapter 8 for the auxiliary amplitude value of each display format. (Query only)

■ Query Response

{*numeric*} <new line><^END>

MKRCENT

Sets the sweep parameter center value of the destination channel to the sweep parameter value of the marker and centers the new span about that value. (MKR→CENTER under Marker→); No query)

MKRCONT \square {OFF|ON|0|1}

Sets the continuous or discontinuous marker mode. (MKR [] under Marker)

Parameter	Description
OFF or 0	Discontinuous marker mode.
ON or 1	Continuous marker mode.

■ Query Response

{0|1} <new line><^END>

MKRCOUP \square {OFF|ON|0|1}

Sets the coupled or uncoupled marker mode. (MKR [] under Marker)

Parameter	Description
OFF or 0	Uncoupled marker mode
ON or 1	Coupled marker mode

■ Query Response

{0|1} <new line><^END>

MKRDELA

Sets the group delay at the marker point of a fixed frequency aperture, 20% of the span, to the electrical delay to balance the phase of the DUT. (Network analyzer only) (MKR—DELAY under Scale Ref); No query)

MKRL \square {OFF|ON|0|1}

Sets the maker list function ON or OFF. (MKR LIST ON off under Utility)

Parameter	Description
OFF or 0	Marker list function OFF
ON or 1	Marker list function ON

■ Query Response

{0|1} <new line><^END>

MKRMIDD

Sets the midpoint the LIMD command using the marker to set the middle amplitude value of a limit segment. (**MKR→MIDDLE** under **(System)**; No query)

This command is valid while editing a segment in a limit line table.

MKRNOI□{OFF|ON|0|1}

Sets the noise format of the marker ON or OFF. This marker reads out the average noise level at the marker position (referenced to a 1 Hz noise power bandwidth). (Spectrum analyzer only) (**NOISE FORM ON off** under **(Utility)**)

This command is valid when the display format is set to “spectrum” by FMT SPECT command.

■ Query Response

{0|1} <new line><^END>

MKRO□{DATA|MEMO}

Sets a trace from data or memory to be applied for the marker values. (**MKR ON []** under **(Marker)**)

Parameter	Description
DATA	DATA TRACE
MEMO	MEMORY TRACE

■ Query Response

{DATA|MEMO} <new line><^END>

MKROFS

Sets the marker's amplitude value into the offset value. (**MKR→OFFSET** under **(Display)**; No query)

MKRP \square <numeric>

Moves the marker to the specified data point number.

Parameter	Description
<numeric>	1 to Number of Points

■ Query Response

{numeric} <new line> <^END>

MKRPKD

Sets the peak delta value to the smaller value of the difference of amplitude values between the present marker position and both side display points of the marker. (Network and impedance analyzers only) (MKR→PEAK DELTA under **Search**); No query)

MKRPRM \square <numeric> [HZ|DBM]

Sets the marker at the point of the specified sweep parameter, when the marker is ON.

Parameter	Range	Unit
<numeric>	start value to stop value	Hz (frequency) dBm (power)

■ Query Response

{numeric} <new line> <^END>

MKRREF

Makes the reference value of the destination channel equal to the marker's absolute value (regardless of the Δ marker value). (MKR→REFERENCE under **Scale Ref** and **Marker→**); No query)

MKRSTAR

Sets the start value sweep parameter of the destination channel to the sweep parameter value of the marker. When editing a segment in a list sweep table, sets the start value sweep parameter of the segment to the sweep parameter value of the marker. (SEGMENT: MKR→START under **Sweep**, or MKR→START under **Marker→**); No query)

MKRSTOP

Sets the sweep parameter start value of the destination channel to the sweep parameter value of the marker. (SEGMENT: MKR→START under **Sweep**, or MKR→START under **Marker→**); No query)

MKRSWPRM

Sets the segment sweep parameter value to the present marker sweep parameter value. This command is used when editing a limit line table. (MKR→SWP PARAM under **System**); No query)

MKRTHRE

Sets the threshold value to the amplitude value of the present marker position. (MKR→THRESHOLD under **Search**); No query)

MKRTIME □ {OFF|ON|0|1}

Sets the x-axis units to time, (the start point is zero and the stop point is the value of the sweep time). (MKR TIME ON off under **Utility**)

Parameter	Description
OFF or 0	Sets the x-axis to the sweep parameter
ON or 1	Sets the x-axis to time

■ Query Response

{0|1} <new line><^END>

MKRUNIT □{DBM|DBV|DBUV|W|V}

Selects the unit of the marker readout on the active channel when operating in the spectrum analyzer mode. (Spectrum analyzer only) (UNIT: dBm, dBV, dB μ V, WATT, VOLT under **Utility**)

Parameter	Description
DBM	dBm
DBV	dBV
DBUV	dB μ V
W	Watt
V	Volt

MKRVAL?

Outputs the amplitude value of the measurement value at the marker position. See “Marker Readout” in Chapter 8 for the amplitude value of each display format. (Query only)

■ Query Response

{*numeric*} <new line><^END>

MKRZM

Sets the sweep parameter center value of the destination channel to the sweep parameter value of the marker, and changes the sweep parameter span value of the destination channel to “sweep parameter span \times zooming aperture.” (MKR ZOOM under **Marker**→; No query)

MODI1

Leads to the modify calibration kit menu, where a calibration kit can be user-modified. (Network and impedance analyzers only) (MODIFY [] under **Cal**); No query)

MODICOMK

Leads to the modify fixture compensation kit menu. (MODIFY [] under Cal COMPEN KIT[] ; No query; Impedance analyzer only.)

MODIFIX

Leads to the modify user fixture menu. (MODIFY [] under Meas FIXTURE[] ; No query; Impedance analyzer only.)

MONDYEAR

Changes the displayed date to the “month:day:year” format. (DATE MODE: MonDayYear under System)

■ Query Response

{0|1} <new line><^END>

Parameter	Description
0	“day:month:year” format
1	“month:day:year” format

Commands in Entry Block N

NA

Selects the network analyzer as the analyzer type. (**NETWORK ANALYZER** under **Meas**)

■ Query Response

{0|1} <new line><^END>

Parameter	Description
0	Network analyzer is not selected.
1	Network analyzer is selected.

NEGL

Sets the I/O signal from the 24-bit I/O port as negative logic.

NEXP

Displays the next page of information in a tabular listing. (**NEXT PAGE** under **Copy**; No query)

NUMG□<numeric>

Triggers a user-specified number of sweeps and returns to the HOLD mode.

(**NUMBER OF GROUPS** under **Trigger**; No query)

Parameter	Description
<numeric>	1 to 999 (if <numeric> is 0 or less than 0, it is set to 1.)

■ Query Response

{numeric} <new line><^END>

O

Commands in Entry Block O (*O included)

OFSD \square $\langle numeric \rangle$ [S]

Specifies the one-way electrical delay from the measurement (reference) plane to the standard. (Network and impedance analyzers only) (OFFSET DELAY under Cal); No query)

Parameter	Range	Unit
$\langle numeric \rangle$	-0.01 to 0.01 (1.0×10^{-9} resolution)	sec

■ Query Response

{*numeric*} <new line><^END>

OFSL \square $\langle numeric \rangle$

Specifies energy loss, due to skin effect, along a one-way length of coaxial cable offset. (Network and impedance analyzers only) (OFFSET LOSS under Cal); No query)

Parameter	Range	Unit
$\langle numeric \rangle$	0 to 1×10^{15}	Ω/s or $G\Omega/s$

■ Query Response

{*numeric*} <new line><^END>

OFSZ \square <numeric> [OHM]

Specifies the characteristic impedance of the coaxial cable offset. (Network and impedance analyzers only) (`OFFSET Z0` under `Cal`); No query)

Parameter	Range	Unit
<numeric>	0.001 to 5000000 (=5M)	Ω

■ Query Response

{numeric} <new line><^END>

OMII

Omits correction for isolation of a 2-port calibration. (Network analyzer only) (`OMIT ISOLATION` under `Cal`); No query)

*OPC

Tells the analyzer to set bit 0 (Operation Complete bit) in the Standard Event Status Register when it completes all pending operations.

*OPC? query places an ASCII character 1 into the analyzer's output queue when all pending operations have been completed.

■ Query Response

{1} <new line><^END>

OPEP

Provides a tabular listing on the display of the key parameters for both channels. (`OPERATING PARAMETERS` under `Copy`); No query)

***OPT?**

Queries the options installed. (Query only)

■ Query Response

{parameter} <new line><^END>

Parameter	Description
(Null)	None
1G2	HP Instrument BASIC
1D6	Time-gated spectrum analysis

OSE□<numeric>

Enables the operational status register.

Parameter	Description
<numeric>	Decimal expression of the contents of the register, 0 to 65535 ($=2^{16}-1$)

■ Query Response

{numeric} <new line><^END>

OSER?

Outputs the current value in the event register of an operational status register. (Query only)

■ Query Response

{numeric} <new line><^END>

OSNT□<numeric>

Sets the negative transition filter of an operational status register.

Parameter	Description
<numeric>	Decimal expression of the contents of the register, 0 to 65535 ($=2^{16}-1$)

■ Query Response

{numeric} <new line><^END>

OSPT□<numeric>

Sets the positive transition filter of an operational status register.

Parameter	Description
<numeric>	Decimal expression of the contents of the register, 0 to 65535 ($=2^{16}-1$)

■ Query Response

{numeric} <new line><^END>

OSR?

Outputs the operational status register value. (Query only)

■ Query Response

{numeric} <new line><^END>

OUT1ENV{H|L}

Sets the 24-bit I/O port, OUTPUT1, to become HIGH (or LOW) when INPUT1 detects pulse input.

OUT1{H|L}

Sets the 24-bit I/O port, OUTPUT1, to HIGH (or LOW).

OUT2ENV{H|L}

Sets the 24-bit I/O port, OUTPUT2, to become HIGH (or LOW)when INPUT1 detects pulse input.

Note MODIFY JAPANESE TEXT



OUT2{H|L}

Sets the 24-bit I/O port, OUTPUT2, to HIGH (or LOW).

Note MODIFY JAPANESE TEXT



OUT8IO□<numeric>

Outputs the data to the 8-bit parallel output port. (No query)

Parameter	Description
<numeric>	0 to 255

OUTAIO□<numeric>

Outputs 8-bit wide data to the 24-bit I/O port, the port A. (No Query)

Parameter	Description
<numeric>	0 to 255

OUTBIO□<numeric>

Outputs 8-bit wide data to the 24-bit I/O port, the port B. (No Query)

Parameter	Description
<numeric>	0 to 255

OUTCIO□<numeric>

Outputs 4-bit wide data to the 24-bit I/O port, the port C. (No Query)

You must first use **COUT** to set the port C as the output port before using this command.

Parameter	Description
<numeric>	0 to 15

OUTDIO□<numeric>

Outputs 4-bit wide data to the 24-bit I/O port, the port D. (No Query)

You must first use **COUT** to set the port D as the output port before using this command.

Parameter	Description
<numeric>	0 to 15

OUTEIO□<numeric>

Outputs 8-bit wide data to the 24-bit I/O port, the port E. (No Query)

You must set the port C, D as the output ports with COUT and DOUT before using this command.

Parameter	Description
<numeric>	0 to 255

OUTFIO□<numeric>

Outputs 16-bit wide data to the 24-bit I/O port, the port F. (No Query)

Parameter	Description
<numeric>	0 to 65535

OUTGIO□<numeric>

Outputs 20-bit wide data to the 24-bit I/O port, the port G. (No Query)

You must first use COUT to set the port C as the output port before using this command.

Parameter	Description
<numeric>	0 to 1048575

OUTHIO□<numeric>

Outputs 24-bit wide data to the 24-bit I/O port, the port H. (No Query)

You must set the port C, D as the output ports with COUT and DOUT before using this command.

Parameter	Description
<numeric>	0 to 16777215

OUTPCALC{1-12}?

Outputs the active calibration set array of the active channel. (Network and impedance analyzers only) (Query only)

■ Query Response

{*numeric (1)*} {*numeric (2)*} ... {*numeric (n)*} <new line><^END> (n is the number of points.)

numeric is a complex number (data format: real, imaginary).

OUTPCALK?

Outputs the active calibration kit. (Network and impedance analyzers only) (Query only)

■ Query Response

{block data (714 bytes of binary data)} <new line><^END>

OUTPCOMC{1|2|3}?

Outputs data of the fixture compensation arrays. See “INPUCOMC{1|2|3}□□□<*numeric (1)*>, <*numeric (2)*>, ... , <*numeric (n)*>” in Appendix I for details about the fixture compensation arrays. (Impedance analyzer only)

■ Query Response

{*numeric (1)*} {*numeric (2)*} ... {*numeric (n)*} <new line><^END>

(n is the number of points.)

numeric is a complex number. (data format: real, imaginary)

OUTPCOMK?

Outputs data of the fixture compensation kit that is currently defined.

OUTPINPCIO?

Loads data through port C of the 24-bit I/O port and returns the value to GPIB (Query only).

Use CIN to specify port C as an input port before using this command.

■ Query Response

{*numeric*} <new line><^END>

OUTPDATA?

Outputs the error corrected data. (Query only)

■ Query Response

{*numeric (1)*} {*numeric (2)*} ... {*numeric (n)*} <new line><^END>

(n is the number of points.)

numeric is a complex number (data format: real, imaginary) for the Network analyzer, or a real number for the Spectrum analyzer.

OUTPDATAP?□<numeric>

Outputs the error corrected data at the specified point. (Query only)

Parameter	Description
<numeric>	1 to "number of points" (If <numeric> is 0 or less than 0, it is set to 1. If <numeric> is greater than "number of points," it is set to "number of points.")

■ Query Response

{*numeric (real)*} {*numeric (imaginary)*} <new line><^END> (Network analyzer)

{*numeric (val)*} <new line><^END> (Spectrum analyzer)

OUTPDMKR?

Outputs sweep parameter and measurement value at the Δ marker position. (Query only)

■ Query Response

{*numeric (val1)*} {*numeric (val2)*} {*numeric (stimulus)*} <new line><^END>

(Val1: Amplitude value, Val2: Auxiliary amplitude value.)

OUTPDTRC?

Outputs DATA TRACE data. (Query only)

■ Query Response

{*numeric (1:val1)*} {*numeric (1:val2)*} {*numeric (2:val1)*} {*numeric (2:val2)*} ...
{*numeric (n:val2)*} {*numeric (n:val2)*} <new line><^END> (Network analyzer)

{*numeric (1)*} {*numeric (2)*} ... {*numeric (n)*} <new line><^END> (Spectrum analyzer)

(n is the number of points.) (Val1: Amplitude value, Val2: Auxiliary amplitude value.)

OUTPDTRCP? □ <numeric>

Outputs DATA TRACE data at the specified point. (Query only)

Parameter	Description
<numeric>	1 to "number of points" (If <numeric> is 0 or less than 0, it is set to 1. If <numeric> is greater than "number of points," it is set to "number of points.")

■ Query Response

{*numeric (val1)*} {*numeric (val2)*} <new line><^END> (Network analyzer)

{*numeric (val)*} <new line><^END> (Spectrum analyzer)

(Val1: Amplitude value, Val2: Auxiliary amplitude value.)

OUTPERRO?

Outputs the error message in the error queue.

- Query Response

{numeric (Error number)} *{string (Error message)}* <new line><^END>

When no message is in the queue: 0, "No error" <new line><^END>

OUTPFAIP?

Outputs number of the failed point of the limit test. (Query only)

- Query Response

{numeric} <new line><^END>

OUTPINPCIO?

Note OUTPINP[C|D|E]IO? DOUBLED?



Loads data through port C of the 24-bit I/O port and returns the value to GPIB (Query only).

Use CIN to specify port C as an input port before using this command.

- Query Response

{numeric} <new line><^END>

OUTPINPDIO?

Loads data through port D of the 24-bit I/O port and returns the value to GPIB (Query only).

Use DIN to specify port D as an input port before using this command.

- Query Response

{numeric} <new line><^END>

OUTPINPEIO?

Loads data through port E of the 24-bit I/O port and returns the value to GPIB (Query only).

Use CIN and DIN to specify port C and D as an input port before using this command.

■ Query Response

{*numeric*} <new line><^END>

OUTPLIMF?

Outputs the limit test results only for the failed points. (Query only)

■ Query Response

{*numeric (stimulus 1)*} {0} {*numeric (upper_limit 1)*} {*numeric (lower_limit 1)*}
{*numeric (stimulus 2)*} {0} {*numeric (upper_limit 2)*} {*numeric (lower_limit 2)*}
⋮
{*numeric (stimulus n)*} {0} {*numeric (upper_limit n)*} {*numeric (lower_limit n)*} <new
line><^END> (Form 4)

(n is the number of failed points.)

{0} <new line><^END> (for no failed points.)

OUTPLIML?

Outputs the limit test results for each point. (Query only)

■ Query Response

{*numeric (stimulus 1)*} {*numeric (result 1)*} {*numeric (upper_limit 1)*}
{*numeric (lower_limit 1)*}

{*numeric (stimulus 2)*} {*numeric (result 2)*} {*numeric (upper_limit 2)*}
{*numeric (lower_limit 2)*}

⋮

{*numeric (stimulus n)*} {*numeric (result n)*} {*numeric (upper_limit n)*}
{*numeric (lower_limit n)*} <new line><^END> (Form 4)

(n is the number of points.) (*result* is 1 for pass, 0 for fail, or -1 for no test.)

OUTPLIMM?

Outputs the limit test result for the marker position. (Query only)

■ Query Response

{*numeric (stimulus)*} {*numeric (result)*} {*numeric (upper_limit)*} {*numeric (lower_limit)*}
<new line><^END>

(*result* is 1 for pass, 0 for fail, or -1 for no test)

OUTPMEMO?

Outputs the memory data from the active channel. (Query only)

■ Query Response

{*numeric (1)*} {*numeric (2)*} ... {*numeric (n)*} <new line><^END>

(*n* is the number of points.)

numeric is a complex number (data format: real, imaginary) for the Network analyzer, or a real number for the Spectrum analyzer.

OUTPMEMOP?□<numeric>

Outputs the memory data from the active channel at a specified point. (Query only)

Parameter	Description
<value>	1 to "number of points" (If <numeric> is 0 or less than 0, it is set to 1. If <numeric> is greater than "number of points," it is set to "number of points.")

■ Query Response

{real} {imaginary} <new line><^END> (Network analyzer)

{numeric} <new line><^END> (Spectrum analyzer)

OUTPMKR?

Outputs the sweep parameter and measurement values at the marker position. (Query only)

■ Query Response

{*numeric (val1)*} {*numeric (val2)*} {*numeric (stimulus)*} <new line><^END>

(Val1: Amplitude value, Val2: Auxiliary amplitude value.)

OUTPMSTA?

Outputs the marker statistics. (**STATISTICS ON off** under **Utility**); Query only)

■ Query Response

{*numeric (mean)*} {*numeric (standard deviation)*} {*numeric (peak to peak)*}
<new line><^END>

OUTPMTRC?

Outputs the MEMORY TRACE data. (Query only)

■ Query Response

{*numeric (1:val1)*} {*numeric (1:val2)*} {*numeric (2:val1)*} {*numeric (2:val)*} ...
{*numeric (n:val1)*} {*numeric (n:val2)*} <new line><^END> (Network analyzer)

{*numeric (1)*} {*numeric (2)*} ... {*numeric (n)*} <new line><^END> (Spectrum analyzer)

(n is the number of points.) (Val1: Amplitude value, Val2: Auxiliary amplitude value.)

OUTPMTRCP?□<numeric>

Outputs the MEMORY TRACE data at the specified point. (Query only)

Parameter	Description
<numeric>	1 to "number of points" (If <numeric> is 0 or less than 0, it is set to 1. If <numeric> is greater than "number of points," it is set to "number of points.")

■ Query Response

{*numeric (val1)*} {*numeric (val2)*} <new line><^END> (Network analyzer)

{*numeric (val)*} <new line><^END> (Spectrum analyzer)

(Val1: Amplitude value, Val2: Auxiliary amplitude value.)

OUTPMWID?

Outputs the results of the bandwidth search. (Network and impedance analyzers only)
 (WIDTHS ON off under Search); Query only)

- Query Response

{*numeric (bandwidth)*} {*numeric (center)*} {*numeric (Q)*} <new line><^END>

OUTPRAW{1-4}?

Outputs the uncorrected data arrays for the active channel. (Query only)

- Query Response

{*numeric (1)*} {*numeric (2)*} ... {*numeric (n)*} <new line><^END>

(n is the number of points.)

numeric is a complex number (data format: real, imaginary) for the Network analyzer,
 or a real number for the Spectrum analyzer.

OUTPSMKR{1-7}?

Outputs the measurement values and sweep parameter at the sub-marker position. (Query only)

- Query Response

{*numeric (val1)*} {*numeric (val2)*} {*numeric (stimulus)*} <new line><^END>

(Val1: Amplitude value, Val2: Auxiliary amplitude value.)

OUTPSWPRM?

Outputs the sweep parameter data. (Query only)

- Query Response

{*numeric 1*} {*numeric 2*} ... {*numeric n*} <new line><^END>

(n is the number of points.)

OUTPSWPRMP? <numeric>

Outputs the sweep parameter data at a specified point. (Query only)

Parameter	Description
<numeric>	1 to "number of points" (If <numeric> is 0 or less than 0, it is set to 1. If <numeric> is greater than "number of points," it is set to "number of points.")

■ Query Response

{numeric} <new line><^END>

Commands in Entry Block P (*P included)

PARS \square {OFF|ON|0|1}

Sets the partial search of the marker search function ON or OFF. (PART SRCH ON off under **Search**)

Parameter	Description
OFF or 0	Partial search OFF
ON or 1	Partial search ON

■ Query Response

{0|1} <new line><^END>

*PCB \square <numeric>

Specifies the address of a controller that is temporarily passing GPIB control to the analyzer. (Option 1C2 only; No query)

Parameter	Description
<numeric>	0 to 30

PEAKCENT

Searches for a peak using the marker and then changes the CENTER of the destination channel to the sweep parameter value of that peak. (PEAK→CENTER under **Center** or **Marker→**); No query)

PEAKREF

Searches for a peak using the marker and applies a sweep parameter at the marker to the reference value of the sweep parameters for the destination channel. The sweep parameter specified is an absolute value; not a difference even if a Δ marker is used. (Spectrum analyzer only) (`PEAK→REFERENCE` under `Scale Ref`); No query)

PEN□{1-6}

Specifies the pen to be used in displaying a data trace by `DATOVE` command. (`SELECT PEN COLOR` under `Display`); No query)

The color for each pen can be specified using `COL0` command.

Parameter	Description
1	PEN 1
2	PEN 2
3	PEN 3
4	PEN 4
5	PEN 5
6	PEN 6

PHAO□<numeric>[DEG]

Adds or subtracts a phase offset that is constant with frequency. (Network analyzer only) (`PHASE OFFSET` under `Scale Ref`)

Parameter	Range	Unit
<numeric>	-360 to +360	°

■ Query Response

{numeric} <new line><^END>

PHAU {RAD|DEG}

Selects the unit of phase format. (PHASE UNIT □ under **Format**); Impedance analyzer only.)

Parameter	Description
DEG	Degree.
RAD	Radian.

- Query Response

{DEG|RAD} <new line> <^END>

PKDLTX□<numeric> [HZ|DBM]

Sets the peak ΔX value that is used to define the peak. (Network and impedance analyzers only) (PEAK DEF: ΔX under **Search**)

Parameter	Range	Unit
<numeric>	1×10^{-9} to 1×10^9	Hz (frequency) dBm (power)

- Query Response

{numeric} <new line> <^END>

PKDLTY□<numeric>

Sets the peak ΔY value that is used to define the peak. (PEAK DEF: ΔY under **Search**)

Parameter	Range	Format
<numeric>	-1×10^9 to 1×10^9	???

- Query Response

{numeric} <new line> <^END>

PKPOL \square {POS|NEG}

Sets the peak polarity for the marker search functions. (Network and impedance Analyzers only) (PEAK PLRTY pos neg under [Search](#))

Parameter	Description
POS	Positive peak
NEG	Negative peak

■ Query Response

{POS|NEG} <new line><^END>

PKTHRE \square {OFF|ON|0|1}

Sets the threshold ON or OFF. (THRESHOLD ON off under [Search](#))

Parameter	Description
OFF or 0	Threshold OFF
ON or 1	Threshold ON

■ Query Response

{0|1} <new line><^END>

PKTHVAL \square <numeric>

Sets the threshold values. (THRESHOLD VALUE under [Search](#))

Parameter	Range	Unit
<numeric>	-1×10^9 to 1×10^9	???

■ Query Response

{numeric} <new line><^END>

POIN□<numeric>

Sets the number of points for the segment, or sets the number of points for the list sweep table. (In the spectrum analyzer mode, this command can set the number of points for zero span measurement only; can be used to query in the other measurement types.)

(NUMBER OF POINTS under **Sweep**)

Parameter	Description
<numeric>	2 to 801.

■ Query Response

{numeric} <new line><^END>

PORE□{OFF|ON|0|1}

Sets the reference plane extension mode ON or OFF. (Network and impedance analyzers only)

(EXTENSIONS ON off under **Cal**)

Parameter	Description
OFF or 0	Reference plane extension mode OFF
ON or 1	Reference plane extension mode ON

■ Query Response

{0|1} <new line><^END>

PORT1□<numeric>[S|MS|US|NS|PS]

Extends the reference plane for measurement of S_{11} , S_{21} , and S_{12} . (Network analyzer only)

(EXTENSION PORT 1 under **Cal**)

Parameter	Range	Unit
<numeric>	-0.01 to 0.01 (1×10^{-12} resolution)	sec

■ Query Response

{numeric} <new line><^END>

PORT2□<numeric>[S]

Extends the reference plane for measurement of S_{22} , S_{12} , and S_{21} . (Network analyzer only)
(EXTENSION PORT 2 under Cal)

Parameter	Range	Unit
<numeric>	-0.01 to 0.01 (1×10^{-12} resolution)	sec

■ Query Response

{numeric} <new line><^END>

PORTA□<numeric>[S]

Adds electrical delay to the input A reference plane for all A input measurements (including S-parameters). (Network analyzer only) (EXTENSION INPUT A under Cal)

Parameter	Range	Unit
<numeric>	-0.01 to 0.01 (1×10^{-12} resolution)	sec

■ Query Response

{numeric} <new line><^END>

PORTB□<numeric>[S]

Adds electrical delay to the input B reference plane for all B input measurements (including S-parameters). (Network analyzer only) (EXTENSION INPUT B under Cal)

Parameter	Range	Unit
<numeric>	-0.01 to 0.01 (1×10^{-12} resolution)	sec

■ Query Response

{numeric} <new line><^END>

PORTR□<numeric>**[S]**

Adds electrical delay to extend the reference plane at input R to the end of cable. The compensation takes effects in all the measurement which use the port R, including S parameter measurement. (Network analyzer only) (**EXTENSION INPUT R** under **Cal**)

Parameter	Range	Unit
<numeric>	-0.01 to 0.01 (1×10 ⁻¹² resolution)	sec

■ Query Response

{numeric} <new line><^END>

PORTZ□<numeric>

Sets the port extension value. (**EXTENSION VALUE** under **Cal**); Impedance analyzer only.)

Parameter	Range	Unit
<numeric>	-10 to 10	sec

■ Query Response

<numeric><new line><^END>

POSL

Sets the I/O signal of 24-bit I/O port to positive logic.

POWE□<numeric>**[DBM]**

Sets the power level segment by segment, or sets the power level for the list sweep table. (**POWER** under **Sweep**)

This command is valid when the linear frequency or log frequency sweeping mode is selected in the network and impedance analyzer modes, or when measuring on zero span in the spectrum analyzer mode.

Parameter	Range	Unit
<numeric>	-50 to 15 (0.1 resolution)	dBm

■ Query Response

{numeric} <new line><^END>

POWE□<numeric>**[DBM]**

PREP

Displays the previous page of information in a tabular listing. (**PREV PAGE** under **Copy**); No query)

PRES

Presets the ANALYZER to the preset default values. See the *Operation Manual* for the default values. The **PRES** command does *not* preset the HP Instrument BASIC. (**PRESET**); No query)

PRIC

Sets the print command to the color printing. (**COLOR** under **Copy**)

■ Query Response

{0|1} <new line><^END>

Parameter	Description
0	Single-color printing
1	Color printing

PRICFIXE

Sets the default colors for printing a hard copy. (**PRINT COLOR [FIXED]** under **Copy**)

■ Query Response

{0|1} <new line><^END>

Parameter	Description
0	Variable colors (colors similar to the display)
1	Fixed colors (default colors)

PRICVARI

Sets the colors used for printing a hard copy as close as possible to the display colors. Refer to “System Accessory Printer” in Chapter 9 of *FuncRef* for the printers which support the variable color printing. (`PRINT COLOR [VARIABLE]` under `Copy`)

■ Query Response

{0|1} <new line><^END>

Parameter	Description
0	Fixed colors (default colors)
1	Variable colors (colors similar to the display)

PRINALL

Causes an extra copy of the display to be printed. (`PRINT []` under `Copy`); No query)

PRIS

Sets the print command to the single color printing. (`PRINT: STANDARD` under `Copy`)

■ Query Response

{0|1} <new line><^END>

Parameter	Description
0	Color printing
1	Single color printing

PRSMKRS

Turns off all markers and cancels all settings of the marker functions. (`PRESET MKRS` under `Marker`); No query)

PRSOFT□{OFF|ON|0|1}

Sets printing the softkeys displayed in the screen ON or OFF. (COPY SKEY under Copy)

Parameter	Description
OFF or 0	Does not print the soft keys
ON or 1	Print the soft keys

■ Query Response

{0|1} <new line><^END>

PURG□<string>

Removes the file. (PURGE FILE under SAVE); No query)

Parameter	Description
<string>	File name, up to 10 characters including the extension

Commands in Entry Block R (*R included)

RAID

Completes the response and isolation calibration. Computes and stores the error coefficients. (Network analyzer only) (`DONE RESP ISOL'N CAL` under `Cal`); No query)

RAISOL

Selects the isolation class for the response and isolation calibration. (Network analyzer only) (`ISOL'N STD` under `Cal`); No query)

RAIRESP

Selects the response class for the response and isolation calibration. (Network analyzer only) (`RESPONSE` under `Cal`); No query)

READ?

Reads data from a file that has been read-enabled using the `ROPEN` command. The returned data is in the fixed length block format defined in IEEE488.2. The fixed length block format, as shown in Figure R-1, consists of a header part indicating the data size and an actual data part. In the case of the 4395A, the number of digits to indicate the data size is 6 and the maximum length of the actual data part is 16 Kbytes. If a file contains data greater than 16 Kbytes, execute this command repeatedly to read it. Note that acceptable file formats for this command are the DOS format and the LIF format BDAT type.

Generally, this command is used in combination with the `ROPEN` command and the `CLOSE` command, as shown in Figure R-2. (Query only)

- Query Response

`{block} <new line><^END>`

READ?

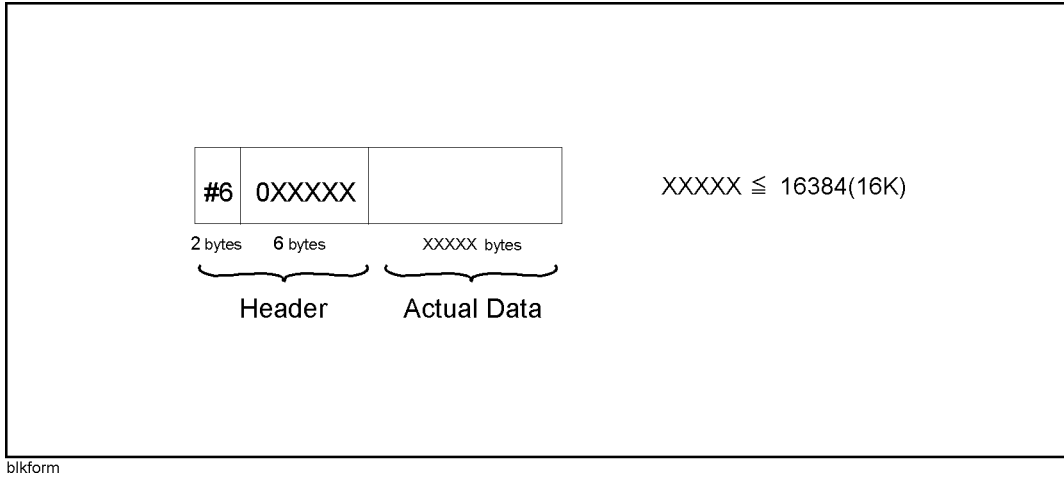

Figure R-1. Fixed length block format

RECC

Recalls the previously saved version of the color set from the non-volatile memory. (RECALL COLORS under **Display**); No query)

RECD \square <string>

Loads the instrument states or data. (file name under **Recall**); No query)

Parameter	Description
<string>	File name, Up to 10 characters including the extension

REFD

Completes with the reflection part of the full 2-port or one-path 2-port calibration. (Network analyzer only) (REFLECT'N DONE under **Cal**); No query)

REFL

Begins the reflection part of the full 2-port or one-path 2-port calibration. (Network analyzer only) (REFLECT'N under Cal); No query)

REFP□<numeric>

Sets the position of the reference line on the graticule of a Cartesian display. (Network and impedance analyzers only) (REFERENCE POSITION under Scale Ref)

Parameter	Range	Unit
<numeric>	0 to 10	Div

REFV□<numeric>

Sets the value of the reference line, moving the measurement trace correspondingly. (REFERENCE VALUE under Scale Ref)

Parameter	Range	Unit
<numeric>	-1×10^9 to 1×10^9	???

■ Query Response

{numeric} <new line><^END>

REFX□<numeric>

Sets the value of the x-axis reference line in complex plane format, moving the measurement trace correspondingly, when the measurement format is set to the complex plane.

(REFERENCE X VALUE under Scale Ref); Impedance analyzer only.)

Parameter	Range	Unit
<numeric>	-1×10^9 to 1×10^9	U

■ Query Response

<numeric><new line><^END>

REFY \square <numeric>

Sets the value of the y-axis reference line in complex plane format, moving the measurement trace correspondingly, when the measurement format is set to the complex plane.

(REFERENCE Y VALUE under **Scale Ref**)

Parameter	Range	Unit
<numeric>	-1×10^9 to 1×10^9	U

■ Query Response

<numeric><new line><^END>

RESAVD \square <string>

Updates a file that is already saved. (**RE-SAVE FILE** under **Save**); No query)

Parameter	Description
<string>	File name up to 10 characters including the extension

RESC

Eliminates the need to restart a calibration sequence that was interrupted to access some other menu. (Network and impedance analyzers only) (**RESUME CAL SEQUENCE** under **Cal**); No query)

RESCOM

Resume the last measured compensation sequence. (**RESUME COMP SEQ** under **Cal**); No query; Impedance analyzer only.)

RESD

Turns off the tabular listing and returns the measurement display to the screen.

(RESTORE DISPLAY under **Copy**); No query)

RESPDONE

Completes the response calibration. Computes and stores the error coefficients. This command also set ??the error compensation function?? on. (Network analyzer only)

(DONE: RESPONSE under **Cal**); No query)

REST

Aborts the sweep in progress and then restarts the measurement. (MEASURE RESTART under **Trigger**); No query)

Measurement will restart on the active channel when dual channel display is disabled (DUAC OFF). When dual channel display is enabled (DUAC ON), measurement will restart on both channels;first on the channel 1 then on the channel 2.

If the sweep trigger is in the HOLD mode, this command executes a single sweep.

RESTMDISK□{2}

Recalls the contents of the built-in RAM disk memory from the built-in flush memory, allowing to use with the parameter to specify the flush memory from which the contents is recalled. (No query)

Parameter	Description
None	Recalls from the backup memory.
2	Recalls from the memory for service/demo/sample.

REVI

Measures S_{12} isolation for the full 2-port calibration. (Network analyzer only)
(`REV ISOL'N ISOL'N STD` under `Cal`); No query)

REVM

Measures S_{22} load match for the full 2-port calibration. (Network analyzer only)
(`REV. MATCH THRU` under `Cal`); No query)

REVT

Measures S_{12} frequency response for the full 2-port calibration. (Network analyzer only)
(`REV. TRANS. THRU` under `Cal`); No query)

RFO `{OFF|ON|0|1}`

Sets the signal output on the RF OUT port ON or OFF. (`RF OUT ON off` under `Source`)

Parameter	Description
OFF or 0	RF OUT port OFF
ON or 1	RF OUT port ON

■ Query Response

`{0|1} <new line><^END>`

ROPEN `<string>`

Makes a specified file read-enabled. If the file does not exist, an error occurs.

Generally, this command is used in combination with the `READ?` command and the `CLOSE` command, as shown in Figure R-2. (No query)

Parameter	Description
<code><string></code>	File name of up to 12 characters including its extension (for the LIF format, up to 10 characters)

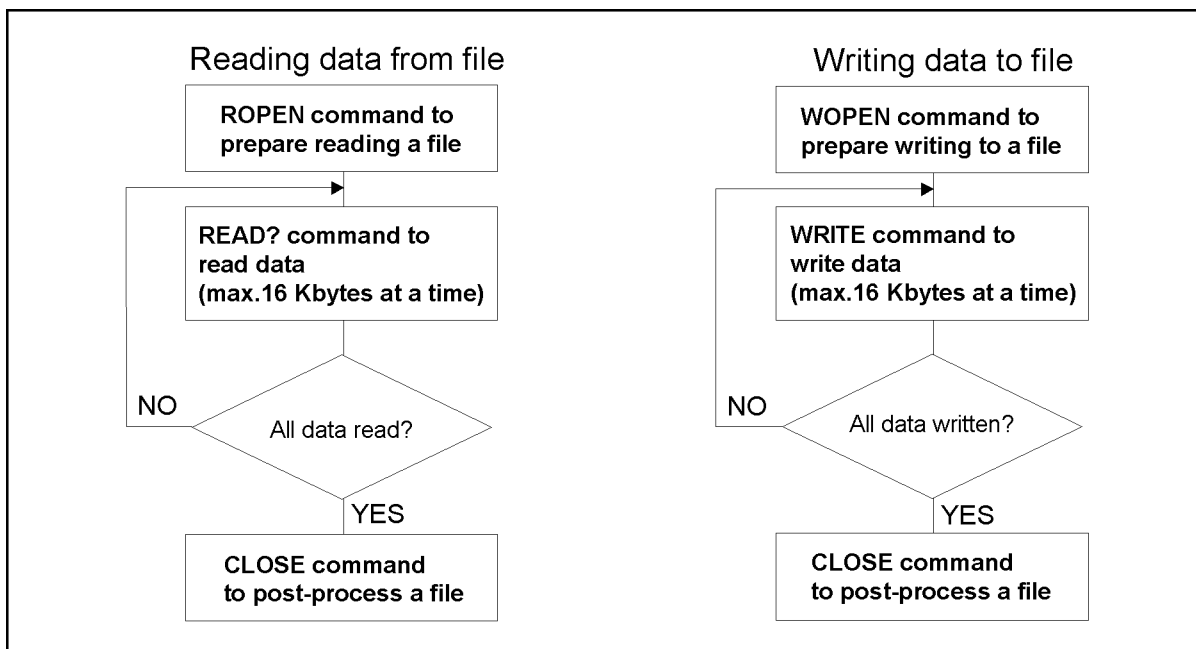

rwflow

Figure R-2. Procedure of executing commands to read/write data

RSCO

Resets the color being modified to the default color. (RESET COLOR under Display); No query)

*RST

Resets the analyzer to its default values (No query):

- Initializes the instrument settings.
- Sets the trigger mode to HOLD.
- Resets HP Instrument BASIC (only if executed on the external controller)

See *Operation Manual* for information on the default values.

Commands in Entry Block S (*S included)

SA

Selects the spectrum analyzer as the analyzer type. (`SPECTRUM ANALYZER` under `Meas`)

■ Query Response

{0|1} <new line><^END>

Parameter	Description
0	Spectrum analyzer is not selected.
1	Spectrum analyzer is selected.

SADD□<numeric>

Adds a new segment to a list sweep table. (`ADD` under `Sweep`); No query)

Parameter	Range	Unit
<numeric>	1 to 51 (Network and impedance analyzers) 1 to 15 (Spectrum analyzer)	

SAUNIT□{DBM|DBV|DBUV|W|V}

Selects the unit of the measurement data on the active channel when operating in the spectrum analyzer mode. (Spectrum analyzer only) (`UNIT: dBm`, `dBV`, `dBμV`, `WATT`, `VOLT` under `Format`)

Parameter	Description
DBM	dBm
DBV	dBV
DBUV	dBμV
W	Watt
V	Volt

■ Query Response

{DBM|DBV|DBUV|W|V|WLOGY|VLOGY} <new line><^END>

SAV1

Completes the S_{11} or S_{22} 1-port calibration. The error coefficients are computed and stored. (Network analyzer only) (DONE: 1-PORT CAL under **Cal**); No query)

SAV2

Completes the full or one-path 2-port calibration. The error coefficients are computed and stored. (Network analyzer only) (DONE: 2-PORT CAL under **Cal**); No query)

SAVC

Initializes and performs error compensation on a raw data array based on the error coefficients array and stores the resulting data on the data trace array. This command then redraws a trace using the current error coefficient array data. (Network and impedance analyzers only) (No query)

This command should be executed after the error coefficients are transferred using INPUCALC- $\{1-12\}$ command.

SAVCAL \square {OFF|ON|0|1}

Selects whether or not to save the calibration coefficients arrays. (CAL ON off under **Save**); No query for the SCPI command)

Parameter	Description
OFF or 0	Does not save the calibration coefficients arrays.
ON or 1	Saves the calibration coefficients arrays.

■ Query Response

{0|1} <new line><^END>

SAVCOM

Calculates the fixture compensation coefficients and store them. This command also enables one of fixture compensation functions (COMDAT{A|B|C}) which applies. (DONE: COMPEN under Cal); No query; Impedance analyzer only)

SAVDASC \square *<string>*

Specifies saving the internal data arrays as an ASCII file. (SAVE ASCII under Save); No query)

Parameter	Description
<i><string></i>	File name, up to 8 characters

SAVDAT \square {OFF|ON|0|1}

Selects whether or not to save the data arrays. (DATA ON off under Save); No query for the SCPI command)

Parameter	Description
OFF or 0	Does not save the data arrays.
ON or 1	Saves the data arrays.

- Query Response

{0|1} <new line><^END>

SAVDDAT \square *<string>*

Specifies saving the internal data arrays which are defined by the SAVRAW, SAVCAL, SAVDAT, SAVMEM, SAVTDAT, and SAVTMEM commands. (SAVE BINARY under Save); No query)

Parameter	Description
<i><string></i>	File name up to 8 characters

SAVDTIF \square <string>

Specifies the file format for saving the screen currently displayed as the TIFF format. (GRAPHICS under Save/Recall; No query)

Parameter	Description
<string>	File name contains up to eight characters.

SAVDSTA \square <string>

Specifies saving only the instrument states and the calibration coefficients. Also saved are the raw data array, the ??TrcMem?? array, the ??DatMem?? array, and the ??Hld?? array. (STATE under Save; No query)

Parameter	Description
<string>	File name up to 8 characters

SAVDTRC \square {OFF|ON|0|1}

Sets whether or not to save the trace arrays. (DATA TRACE ON off under Save; No query for the SCPI command)

Parameter	Description
OFF or 0	Does not save the trace arrays.
ON or 1	Saves the trace arrays.

■ Query Response

{0|1} <new line><^END>

SAVEUSEK

Stores the user-modified or user-defined calibration kit into memory. (Network and impedance analyzers only) (`SAVE USER KIT` under `Cal`); No query)

SAVIMP

Calculates the error-correction coefficients from the calibration data and stores the coefficients. (`DONE:CAL` under `CAL`); No query; Impedance analyzer only)

SAVMEM□{OFF|ON|0|1}

Specifies whether or not to save the memory arrays. (`MEM ON off` under `Save`); No query for the SCPI command)

Parameter	Description
OFF or 0	Does not save the memory arrays.
ON or 1	Saves the memory arrays.

■ Query Response

{0|1} <new line><^END>

SAVMTRC□{OFF|ON|0|1}

Specifies whether or not to save the memory trace arrays. (`MEM TRACE ON off` under `Save`); No query for the SCPI command)

Parameter	Description
OFF or 0	Does not save the memory trace arrays.
ON or 1	Saves the memory trace arrays.

■ Query Response

{0|1} <new line><^END>

SAVRAW \square {OFF|ON|0|1}

Specifies whether or not to save the raw data arrays. (RAW ON off under Save); No query for the SCPI command)

Parameter	Description
OFF or 0	Does not save the raw data arrays.
ON or 1	Saves the raw data arrays.

■ Query Response

{0|1} <new line><^END>

SAVUCOMK

Stores the user-modified compensation kit into memory. (SAVE COMPEN KIT under Cal); No query; Impedance analyzer only)

SAVUFIXT

Saves the settings of user defined fixture. (SAVE USER FXTR KIT under Meas FIXTURE \square); No query; Impedance analyzer only)

SCAC \square {OFF|ON|0|1}

Couples or uncouples the “DATA” and “MEMORY” traces to be scaled. (D&M SCALE [] under Scale Ref);

Parameter	Description
OFF or 0	Uncouples the “DATA” and “MEMORY” traces.
ON or 1	Couples the “DATA” and “MEMORY” traces.

■ Query Response

{0|1} <new line><^END>

SCAF□{DATA|MEMO}

Selects one of the “DATA” or “MEMORY” traces to be scaled. (SCALE FOR [] under Scale Ref); No equivalent SCPI command)

■ Query Response

{DATA|MEMO} <new line><^END>

SCAL□<numeric>

Sets the response value scale per graticule trace. (SCALE/DIV under Scale Ref)

Parameter	Range	Format
<numeric>	If to 100M	???

■ Query Response

{numeric} <new line><^END>

SCRN□{OFF|ON|0|1}

Controls whether the LCD display is visible or not.

Parameter	Description
OFF or 0	Invisible (only softkey labels are displayed.)
ON or 1	Visible

■ Query Response

{0|1} <new line><^END>

SDEL

Deletes a segment from a list sweep table. (**DELETE** under **Sweep**); No query)

Parameter	Range	Unit
<numeric>	1 to 51 (Network and impedance analyzers) 1 to 15 (Spectrum analyzer)	

SDON

Saves the modified segment of a list sweep table and exit the editing. (**SEGMENT DONE** under **Sweep**); No query)

SEAL

Searches the trace for the next occurrence of the target value to the left of the marker. (Network and impedance analyzers only) (**SEARCH LEFT** under **Search**); No query)

SEAM {PEAK|MAX|MIN|TARG|PKSA|PKSR|PKSL|OFF}

Selects the marker search function. (**SEARCH: PEAK**, **MAX**, **MIN**, **TARGET**, **SEARCH: PEAKS ALL**, **PEAKS RIGHT**, **PEAKS LEFT** under **Search**); No query for the SCPI command)

Parameter	Description
PEAK	Peak search
MAX	Maximum search
MIN	Minimum search
TARG	Target search (Network and impedance analyzers only)
PKSA	Peak all
PKSR	Peak right all
PKSL	Peak left all
OFF	Marker search function OFF

■ Query Response

{PEAK|MAX|MIN|TARG|PKSA|PKSR|PKSL|OFF} <new line><^END>

SEANPK

Moves the marker to the next peak. (**NEXT PEAK** under **Search**); No query)

SEANPKL

Moves the marker to the peak to the left of the present marker position. (**NEXT PEAK LEFT** under **Search**); No query)

SEANPKR

Moves the marker to the peak to the right of the present marker position. (**NEXT PEAK RIGHT** under **Search**); No query)

SEAR

Searches the trace for the next occurrence of the target value to the right of the marker. (Network and impedance analyzers only) (**SEARCH RIGHT** under **Search**); No Query)

SEARSTR

Sets the partial search range to the range between the marker and the Δ marker. (**MKR Δ →SEARCH RNG** under **Search**); No query)

SEARSTRL

Sets the left (lower) border of the partial search range at the current position of the marker. (**MKR→LEFT RNG** under **Search**); No query)

SEARSTRR

Sets the right (higher) border of the partial search range at the current position of the marker. (MKR→RIGHT RNG under **Search**); No query

SEATARG□<numeric>[DB|DEG|S|OHM]

Makes the target value to the active function to enter a value and moves the marker to a specified target point on the trace. (Network and impedance analyzers only) (**TARGET** under **Search**)

In the Δmarker mode, specify a relative value to the Δ for the target value.

Parameter	Range	Unit
<numeric>	-1×10 ⁹ to 1×10 ⁹	

■ Query Response

{numeric} <new line><^END>

SEDI□<numeric>

Determines the segment of the list sweep table to be modified. (**EDIT** under **Sweep**); No query for the SCPI command)

Parameter	Range	Unit
<numeric>	1 to 51 (Network and impedance analyzers) 1 to 15 (Spectrum analyzer)	

■ Query Response

{numeric} <new line><^END>

SETCDATE□<numeric (year)>,<numeric (month)>,<numeric (day)>

Sets the date of the internal clock. (**DATE MM/DD/YY** under **System**)

Parameter	Description
<numeric (year)>	1900 to 2099
<numeric (month)>	1 to 12
<numeric (day)>	1 to 31

■ Query Response

{numeric (year)} {numeric (month)} {numeric (day)} <new line><^END>

SETCTIME□<numeric (hour)>,<numeric (minute)>,<numeric (second)>

Sets the time of the internal clock. (**SETCTIME** under **System**)

Parameter	Description
<numeric (hour)>	0 to 23
<numeric (minute)>	0 to 59
<numeric (second)>	0 to 59

■ Query Response

{numeric (hour)} {numeric (minute)} {numeric (second)} <new line><^END>

SETZ□<numeric>[OHM]

Sets the characteristic impedance of the coaxial cable offset. (Network analyzer only)
(**SET Z0** under **Cal**)

Parameter	Range	Unit
<numeric>	0.001 to 5000000 (=5M) (Network analyzer) 50,75 (Spectrum analyzer)	Ω

■ Query Response

{numeric} <new line><^END>

SGTRK \square {OFF|ON|0|1}

Sets the signal tracking function ON or OFF. (Spectrum analyzer only) (SGNL TRACK ON off under Search)

Parameter	Description
OFF or 0	Signal tracking OFF
ON or 1	Signal tracking ON

■ Query Response

{0|1} <new line><^END>

SIMFCHAR

Simulates frequency response of the equivalent circuit. (SIMULTE F-CHAR under Display); No query; Impedance analyzer only)

SING

Makes one sweep of the data and returns to the hold mode. (Instrument BASIC EXECUTE executable; SINGLE under Trigger); No query;)

When you execute this command by EXECUTE command of the instrument BASIC, the analyzer sweeps once and then back the control to the analyzer. The program waits the completion of sweep. You can use this method instead of detecting the sweep end by monitoring the status register to synchronize the program with the analyzer.

SMKR {1-7} \square {OFF|ON|0|1}

Displays the specified sub-marker at the point of the marker (ON), or erases the sub-marker (OFF). (SUB MKR {1-7} under Marker)

Parameter	Description
OFF or 0	Sub-marker ON
ON or 1	Sub-marker OFF

■ Query Response

{0|1} <new line><^END>

SMKRAUV{1-7}?

Outputs the auxiliary amplitude value of the measurement value at the sub-marker position. See “Marker Readout” in Chapter 8 for the auxiliary amplitude value of each display format. (SUB MKR {1-7} under **Marker**); Query only)

■ Query Response

{numeric} <new line><^END>

SMKRP{1-7}□<numeric>

Moves the sub-marker to the specified data point number.

Parameter	Description
<numeric>	1 to “number of points” (If <numeric> is 0 or less than 0, it is set to 1. If <numeric> is greater than “number of points,” it is set to “number of points.”)

■ Query Response

{numeric} <new line><^END>

SMKRPRM{1-7}□<numeric>[HZ|DBM]

Moves the sub-marker to the specified sweep parameter value. (SUB MKR {1-7} under **Marker**)

Parameter	Range	Unit
<numeric>	start value to stop value (0.001 resolution)	Hz (frequency) dBm (power)

■ Query Response

{numeric} <new line><^END>

SMKRVAL{1-7}?

Outputs the primary part of the measurement value at the sub-marker position.

(SUB MKR {1-7} under **Marker**; Query only)

■ Query Response

{*numeric*} <new line><^END>

SPAN□<numeric>[HZ|DBM]

Sets the span of the sweep parameters. This command is not valid when the list sweeping mode is selected. (**Span**)

When editing a list sweep table, the command sets the span of a segment. (**SPAN** under **Sweep**)

Parameter	Range	Unit
<numeric>	0 to 510M (Network and impedance analyzers)	Hz (frequency)
<numeric>	0 to 510M, varies depending on the resolution bandwidth (when setting the sweep span in the spectrum analyzer mode)	
<numeric>	Varies depending on the resolution bandwidth (when editing a segment in the spectrum analyzer mode)	
	0 to 20 (Network and impedance analyzers)	dBm (power)

■ Query Response

{*numeric*} <new line><^END>

SPECFWD{M|T}□<numeric (1)>[,<numeric (2)>[, ... [,<numeric (7)>]

Enters the standard numbers for the forward match (THRU) or forward transmission (THRU) calibration. (Network analyzer only) (**FWD.MATCH**, **FWD.TRANS.** under **Cal**; No query)

Parameter	Description
<numeric>	1 to 8

SPECS11{A|B|C} □ <numeric (1)> [, <numeric (2)> [, ... [, <numeric (7)>]

SPECIMP{A|B|C} □ <numeric 1> [, <numeric 2> [, ... [, <numeric 7>]

Enters the standard numbers for the first, second, or third standard class required for an impedance calibration. (**SPECIFY CLASS** under **Cal**); No query. Impedance analyzer only.)

Parameter	Description
<numeric>	1 to 8

SPECRES{I|P} □ <numeric (1)> [, <numeric (2)> [, ... [, <numeric (7)>]

Enters the standard numbers for a response and isolation, or a response calibration. (Network analyzer only) (**RESPONSE & ISOL'N**, **RESPONSE** under **Cal**); No query)

Parameter	Description
<numeric>	1 to 8

SPECREV{M|T} □ <numeric (1)> [, <numeric (2)> [, ... [, <numeric (7)>]

Enters the standard numbers for the reverse match (THRU) or reverse transmission (THRU) calibration. (Network analyzer only) (**REV.MATCH**, **REV.TRANS.** under **Cal**); No query)

Parameter	Description
<numeric>	1 to 8

SPECS11{A|B|C} □ <numeric (1)> [, <numeric (2)> [, ... [, <numeric (7)>]

Enters the standard numbers for the first, second, or third standard class required for an S₁₁ 1-port calibration. (Network analyzer only) (**SPECIFY: S11A**, **S11B**, **S11C** under **Cal**); No query)

Parameter	Description
<numeric>	1 to 8

SPECS22{**A|B|C**}□<numeric (1)>[,<numeric (2)>[, ... [,<numeric (7)>]

Enters the standard numbers for the first, second, or third standard class required for an S₂₂ 1-port calibration. (Network analyzer only) (SPECIFY: S22A , S22B , S22C under **Cal**); No query)

Parameter	Description
<numeric>	1 to 8

SPLD□{**OFF|ON|0|1**}

Sets the dual channel display mode. (**SPLIT DISP ON off** under **Display**)

Parameter	Description
OFF or 0	Full-screen single graticule display
ON or 1	Split display with two half-screen graticules

■ Query Response

{0|1} <new line><^END>

SQUI

Terminates editing a segment of the list sweep table. (**SEGMENT QUIT** under **Sweep**); No query)

***SRE**□<numeric>

Sets the enable bits of the Status Byte Register.

Parameter	Description
<numeric>	0 to 255 (decimal expression of enable bits of the status byte register)

■ Query Response

{numeric} <new line><^END>

STAN{A-G}

Measures the calibration standard in the current standard class. (Network analyzer only)
 (OPEN, SHORT, THRU, OPEN [], SHORT [], defined std {1-7} under Cal); No query)

STAR□<numeric>[HZ|DBM]

Sets the start value of the sweep parameters. This command is not valid when the list sweeping mode is selected. (Start)

When editing a list sweep table, the command sets the start value of a segment.
 (SEGMENT: START under Sweep)

Parameter	Range	Unit
<numeric>	0 to 510M (Spectrum analyzer)	Hz (frequency)
	10 to 510M (Network and impedance analyzers)	
	-50 to 15 (Network and impedance analyzers)	dBm (power)

- Query Response

{numeric} <new line><^END>

***STB?**

Reads the Status Byte Register by reading the master summary status bit. (Query only)

- Query Response

{numeric} <new line><^END>

STDD

Terminates the standard definition. (Network and impedance analyzers only)
 (STD DONE (DEFINED) under Cal); No query)

STDT□{OPEN|SHOR|LOAD|DELA|ARBI}

Defines the standard type. (Network and impedance analyzers only) (STD TYPE: OPEN, SHORT, LOAD, DELAY/THRU, ARBITRARY IMPEDANCE under **Cal**)

Parameter	Description
OPEN	OPEN
SHOR	SHORT
LOAD	LOAD
DELA	Transmission line of specified length
ARBI	LOAD with an arbitrary impedance

■ Query Response

{OPEN|SHOR|LOAD|DELA|ARBI} <new line><^END>

STOD{DISK|MEMO}

Sets the storage device. (STOR DEV[] under **Save**; No query; No equivalent SCPI command)

Parameter	Description
STODDISK	Flexible disk drive
STODMEMO	RAM disk memory

STOP□<numeric>[HZ|DBM]

Sets the stop value of the sweep parameters. This command is not valid when the list sweeping mode is selected. (**Stop**)

When editing a list sweep table, the command sets the stop value of a segment.

(SEGMENT: STOP under **Sweep**)

Parameter	Range	Unit
<numeric>	0 to 510M (Spectrum analyzer)	Hz (frequency)
	10 to 510M (Network and impedance analyzers)	
	-50 to 15 (Network and impedance analyzers)	dBm (power)

■ Query Response

<numeric> <new line><^END>

STORMDISK

Stores the contents of the RAM disk memory in the backup memory. (No query)

SVCO

Saves the modified version of the color set to the non-volatile memory. (**SAVE COLORS** under **Display**); No query)

SWAI□<numeric>

Specifies the time to keep the analyzer waiting for measurement start until the setting for all the segments except the first one is completed. This command is valid if frequency list sweeping is selected. (No query)

Parameter	Range	Unit
<numeric>	1, 2, 3, 4, 5, 6, 7, 8, 9, 10	sec

SWET□<numeric>[S]

Disables the automatic sweep time setting function and sets the sweep time with a specified value. (**SWEEP TIME** under **Sweep**); Query only in the spectrum analyzer)

Parameter	Range	Unit
<numeric>	0(minimum measurement time) to 359999 ¹	sec

¹ The effective upper limit is n×400 sec, where n denotes the number of points. For n=801, it gives 320400 sec.

■ Query Response

{numeric} <new line><^END>

SWETAUTO□{OFF|ON|0|1}

Sets the automatic or manual sweep time. (SWEEP TIME AUTO man under Sweep)

This command is not valid in the spectrum analyzer mode, in which sweep time is automatically set.

Parameter	Description
OFF or 0	Manual sweep time
ON or 1	Automatic sweep time

■ Query Response

{0|1} <new line><^END>

SWPT□{LINF|LOGF|LIST|POWE}

Selects the sweep type. (SWEEP TYPE:LIN FREQ, LOG FREQ, LIST FREQ, POWER SWEEP under Sweep)

Parameter	Description
LINF	Linear frequency
LOGF	Log frequency (Network and impedance analyzers only)
LIST	Frequency list
POWE	Power (Network and impedance analyzers only)

■ Query Response

{LINF|LOGF|LIST|POWE} <new line><^END>

T

Commands in Entry Block T (*T included)

TERI□<numeric>[OHM]

Specifies the (arbitrary) impedance of the standard. (Network and impedance analyzers only)
(**TERMINAL IMPEDANCE** under **Cal**); No query)

Parameter	Range	Unit
<numeric>	0 to 10000 (=10 k)	Ω

TESS?

Outputs the test set identifier. (Network analyzer only) (Query only)

■ Query Response

{0|1} <new line><^END>

Parameter	Description
0	None
1	S-parameter test set

TINT□<numeric>

Adjusts the hue of the specified display element. (**TINT** under **Display**); No equivalent SCPI command)

Parameter	Range	Unit
<numeric>	0 to 100	%

■ Query Response

{numeric} <new line><^END>

TITL□<string>

Sends the string to the title area on the display. (TITLE under Display)

Parameter	Description
<string>	up to 53 characters

■ Query Response

{string} <new line><^END>

TMARG□<numeric>

Specify the value for the top margin of printed paper. (TOP MARGIN under Copy)

Parameter	Range	Unit
<numeric>	0 to 5	inch

■ Query Response

{numeric} <new line><^END>

TOPV□<numeric>

Defines the top border of the display and adjusts the scale value. (TOP VALUE under Scale Ref); Network and impedance analyzers only.)

Parameter	Range	Unit
<numeric>	-1×10 ⁹ to 1×10 ⁹	y-axis unit

■ Query Response

<numeric><new line><^END>

TRACK□{OFF|ON|0|1}

Sets the search tracking function ON or OFF. (SRCH TRACK ON off under **Search**)

■ Query Response

{0|1} <new line><^END>

TRAD

Completes the transmission calibration of the full or one-path 2-port calibration. (Network analyzer only) (TRANS. DONE under **Cal**); No query

TRAN

Starts the transmission part of the full or one-path 2-port calibration. (Network analyzer only) (TRANSMISSION under **Cal**); No query

***TRG**

Triggers the analyzer when the trigger mode is set to BUS trigger. (No query)

TRGEVE□{SWE|POIN}

Selects the trigger event mode. (Network and impedance analyzers only) (TRIG EVENT [] under **Trigger**)

Parameter	Description
SWE	Trigger event on sweep
POIN	Trigger event on point ¹

¹ Available only when the trigger source is the GPIB, Manual, or External trigger.

■ Query Response

{SWE|POIN} <new line><^END>

TRGP□{POS|NEG}

Sets the trigger signal polarity of an external signal connected to the rear panel EXT TRIGGER input. (TRIG PLRTY pos neg under **Trigger**)

Parameter	Description
POS	Positive trigger (low-to-high transition)
NEG	Negative trigger (high-to-low transition)

■ Query Response

{POS|NEG} <new line><^END>

TRGS□{INT|EXT|BUS|MAN|GAT}

Selects the trigger source, which is common to both channels. (TRIGGER: [] under **Trigger**)

Parameter	Description
INT	Internal trigger
EXT	External trigger input from BNC on the rear panel
BUS	GPIB trigger
VID	Video trigger (Spectrum analyzer only)
MAN	Manual trigger
GAT	External gate trigger (Spectrum analyzer and option 1D6 only)

■ Query Response

{INT|EXT|BUS|MAN|GAT} <new line><^END>

*TST?

Executes an internal self-test and returns the test result. (Query only)

■ Query Response

{*numeric*} <new line><^END>

Parameter	Description
0	Pass
1	Fail

Commands in Entry Block U

USKEY

Show ON KEY LABELS of instrument BASIC. (No query)

The USKEY command is equivalent to executing the program shown below;

```
OUTPUT @Hp4396;"KEY 47"  
OUTPUT @Hp4396;"KEY 0"  
OUTPUT @Hp4396;"KEY 6"
```

Note

Only instrument BASIC is available USKEY command.



Commands in Entry Block V

VBW \square \langle *numeric* \rangle

Sets the bandwidth of the video bandwidth filter. (Spectrum analyzer only) (VIDEO BW under **Bw/Avg**)

Parameter	Description
\langle <i>numeric</i> \rangle	RBW/1, RBW/3, RBW/10, RBW/30, RBW/100, RBW/300 (RBW: the current RBW setting)

■ Query Response

{ *numeric* } \langle new line \rangle \langle ^END \rangle

VBWT \square { LIN | LOG }

Selects either the linear or logarithmic video filter. (VBW TYPE [LIN] or [LOG] under **Bw/Avg**)

■ Query Response

{ LIN | LOG } \langle new line \rangle \langle ^END \rangle

VELOFACT \square \langle *numeric* \rangle

Enters the velocity factor used by the analyzer to calculate the equivalent electrical length. (Network and impedance analyzers only) (VELOCITY FACTOR under **Cal**)

Parameter	Range	Unit
\langle <i>numeric</i> \rangle	0 to 10	

■ Query Response

{ *numeric* } \langle new line \rangle \langle ^END \rangle

W

Commands in Entry Block W (*W included)

*WAI

Makes the analyzer wait until all previously sent commands are completed. (No query)

WIDSIN

Searches for the cutoff point on the trace within the current cutoff points. (Network and impedance analyzers only; **SEARCH IN** under **Search**); No query)

WIDSOUT

Searches for the cutoff point on the trace outside of the current cutoff points. (Network and impedance analyzers only; **SEARCH OUT** under **Search**); No query)

WIDT□{OFF|ON|0|1}

Sets the bandwidth search feature ON or OFF. (Network and impedance analyzers only) (**WIDTHS ON off** under **Search**)

Parameter	Description
OFF or 0	Bandwidth search feature OFF
ON or 1	Bandwidth search feature ON (calculates the center stimulus value, bandwidth, Q, insertion loss, and cutoff point deviation from the center of a bandpass or band reject shape on the trace.)

■ Query Response

{0|1} <new line><^END>

WIDV \square \langle *numeric* \rangle

Sets an amplitude parameter that defines the start and stop points for a bandwidth search. (Network and impedance analyzers only) (**WIDTH VALUE** under **Search**)

Parameter	Range	Format
\langle <i>numeric</i> \rangle	-1×10^9 to 1×10^9	????

■ Query Response

{*numeric*} \langle new line \rangle \langle ^END \rangle

WIDVTYPE \square {DIVS2|MULS2|DIV2|FIXed}

Select Maker Width Value Type. When you use **FIXed**, you must specify the bandwidth value by using **WIDV**. (**MKRVAL/(\sqrt{2})**, **MKRVAL*(\sqrt{2})**, **MKRVAL/2**, or **FIXED VALUE** under **Search**) **WIDTH** \square **WIDHT VALUE**. Impedance analyzer only.)

■ Query Response

{DIVS2|MULS2|DIV2|FIX} \langle new line \rangle \langle ^END \rangle

WOPEN \square \langle *string* \rangle [\langle *numeric* \rangle]

If the specified file exists, this command makes it write-enabled; otherwise, creates a new file and makes it write-enabled. This command takes its arguments in a different way, depending on the file format. For a DOS format file you do not have to specify its file size, for a LIF format file you must. Specify the file size, 0 or greater, so that the file can contain the maximum number of bytes used. Note that only the BDAT type is available as the LIF file format.

The format and size of an existing file cannot be changed. Therefore, if you want to change them, delete the file itself using the **PURG** command and then create a new file using this command.

This command is used in combination with the **WRITE** command and the **CLOSE** commands, as shown in Figure R-2. (No query)

Parameter	Description
\langle <i>string</i> \rangle	File name of up to 12 characters including its extension (for the LIF format, up to 10 characters)
\langle <i>numeric</i> \rangle	File size (required only for the LIF format)

WRITE␣<block>

Writes data in a file that has been write-enabled using the **WOPEN** command. Written data must take the fixed length block format (see Figure R-1) defined in IEEE488.2. The maximum length of data is 16 Kbytes. If data is greater than 16 Kbytes, execute this command repeatedly to write it. (No query)

Generally, this command is used in combination with the **WOPEN** command and the **CLOSE** command, as shown in Figure R-2. (No query)

Parameter	Description
<block>	Data in the fixed length block format

Commands in Entry Block X

XMKRCENT

Applies a sweep parameter at the marker to the center value of the sweep parameters for the channel that is not active. (`XCH_MKR→CENTER` under `Marker→`); No query)

Note MODIFY JAPANESE TEXT



XMKRSTAR

Applies a sweep parameter at the marker to the start value of the sweep parameters for the channel that is not active. (`SEGMENT: MKR→START` under `Sweep`, or `XCH_MKR→START` under `Marker→`); No query)

XMKRSTOP

Applies a sweep parameter at the marker to the stop value of the sweep parameters for the channel that is not active. (`SEGMENT: MKR→STOP` under `Sweep`, or `XCH_MKR→STOP` under `Marker→`); No query)

XMKRZM

Applies a sweep parameter at the marker to the center value of the sweep parameters for the channel that is not active, and changes the sweep parameter span value of the channel to “sweep parameter span × zooming aperture.” (`XCH_MKR ZOOM` under `Marker→`); No query)

XPEAKCENT

Searches for a peak using the marker and applies a sweep parameter at the marker to the center value of the sweep parameters for the channel that is not active. (`PEAK→CENTER` under `Center`, or `XCH_PEAK→CENTER` under `Marker→`); No query)

Commands in Entry Block Z (Other commands included)

ZA

Selects the impedance analyzer mode. (IMPEDANCE ANALYZER under Meas)

■ Query Response

{0|1}<new line><^END>

Parameter	Description
0	Impedance analyzer mode is not selected.
1	Impedance analyzer mode is selected.

ZMAPER □ <numeric>

Sets the zooming aperture value as a percentage of the span. (ZOOMING APERTURE under Marker →)

Parameter	Range	Unit
<numeric>	0 to 100 (relative to span. 0.01 resolution)	%

■ Query Response

{numeric} <new line><^END>

Other Commands

Note

The commands in the PROGRAM subsystem are related to HP Instrument BASIC. This command can be used from an external controller only.

:PROGRAM[:SElected]:DEFine□<block>

Creates and downloads programs. The DEFine query uploads programs.

Parameter	Description
<block>	program

The <block> must be arbitrary block program data containing the lines of program code. The first line of <block> must be a header, which shows the program size. There are two formats for the header as follows:

- #0 Allows the OUTPUT statement to send program line until END is specified in the OUTPUT statement.
- #NMM... M Specifies the program size.
 - N specifies the number of digits that define the program size
 - M... M is program size in byte (N digits)

Each line of the program must be separated by <CR> or <CR> <LF>. When the size of the <block> exceeds the amount of available memory in the instrument, the program lines are saved up to the point of memory overflow.

In the response to the DEFine query, the selected program and its size are returned. The selected program must be in either the paused or stopped state for the program to be uploaded. The <block> is uploaded as definite length arbitrary block response data. The program size is returned in the first line as the header, then program lines are returned.

- Query Response

{block} <new line><^END>

:PROG[:SELEcted]:NUMBer␣<string>,<numeric (1)> ...

:PROG[:SELEcted]:DELEte[:SELEcted]

Deletes the program in the BASIC editor of the analyzer. (No query)

:PROG[:SELEcted]:DELEte:ALL

Deletes the program in the BASIC editor of the analyzer. (No query)

:PROG[:SELEcted]:EXECute␣<string>

Executes the program command. The program must be in either paused or stopped before the EXECute command is allowed. (No query)

Parameter	Description
<string>	Legal program command

:PROG[:SELEcted]:MALLocate␣{<numeric>|DEFault}

Performs no function in the analyzer's HP Instrument BASIC.

:PROG[:SELEcted]:NAME␣<string>

Performs no function in the analyzer's HP Instrument BASIC.

:PROG[:SELEcted]:NUMBer␣<string>,<numeric (1)>[,<numeric (2)>[, ... [,<numeric (n)>]

Sets or queries the contents of numeric program variables and arrays in the program on the BASIC editor of the analyzer.

Parameter	Description
<string>	Name of an existing variable in the selected program (either character data or string data)
<numeric>	Value to be set the variable (use a comma to separate multiple entries)

■ Query Response

{numeric 1} [{numeric 2} [... [{numeric n}] ...]] <new line><^END> (n:the size of the array.)

:PROGram[:SElected]:STATe□{**RUN**|**PAUSE**|**STOP**|**CONTInue**}

Sets or queries the state of the program in the BASIC editor of the analyzer. The table below defines the affect of setting the state to the specified state from each of the possible current states.

Desired State	Current State		
	RUN	PAUSE	STOP
RUN	error (-221)	RUN	RUN
CONT	error (-221)	RUN	error (-221)
PAUSE	PAUSE	PAUSE	STOP
STOP	STOP	STOP	STOP

■ Query Response

{“RUN”|“PAUS”|“STOP”|“CONT”} <new line><^END>

:PROGram[:SElected]:STRing□<*string (varname)*>,<*string (value 1)*>[,<*string (value 2)*> [, ... [,<*string (value n)*>]]

Sets or queries the contents of string program variables and arrays in the program in the BASIC editor of the analyzer. If a string value is too long it is truncated when stored in the program’s variable.

Parameter	Description
< <i>string (varname)</i> >	Name of an existing variable in the selected program (either character data or string data).
< <i>string (value)</i> >	Value to be set the variable (use a comma to separate multiple entries)

■ Query Response

{*string 1*} [{*string 2*} [... [{*string n*} ...]] (n:the size of an array) <new line><^END>

:PROGram:EXPLicit:EXECute□“PROG”,<string>

:PROGram[:SElected]:WAIT

Causes no further commands or queries to be executed until the specified program exits from the RUN state. That is, the program is either stopped or paused. When used as a query command, it returns the status of the program.

■ Query Response

{1} <new line><^END>

1 is returned when the program is either stopped or paused.

Note



The following commands under the **EXPLicit** node perform the specified functions in the same manner as the corresponding commands under the **SElected** node. The **EXPLicit** commands are included in the analyzer's GPIB commands to maintain compatibility with other SCPI instruments. Therefore, you can use either the **EXPLicit** or the **SElected** commands for the analyzer. However, you should select one set and use it consistently to avoid confusion.

:PROGram:EXPLicit:DEFine□“PROG”,<string>

See “:PROGram[:SElected]:DEFine□<block>”.

:PROGram:EXPLicit:DELeTe□“PROG”

See “:PROGram[:SElected]:DELeTe[:SElected]”.

:PROGram:EXPLicit:EXECute□“PROG”,<string>

See “:PROGram[:SElected]:EXECute□<string>”.

:PROGrama:EXPLicit:MALLocate□“PROG”,{<numeric>|DEFault}

See “:PROGrama[:SElected]:MALLocate□{<numeric>|DEFault}”.

:PROGrama:EXPLicit:NAME□“PROG”,<string>

See “:PROGrama[:SElected]:NAME□<string>”.

:PROGrama:EXPLicit:NUMBer□“PROG”,<string> [,<numeric>]

See “:PROGrama[:SElected]:NUMBer□<string>,<numeric (1)>[,<numeric (2)>[, ...
[,<numeric (n)>]”.

:PROGrama:EXPLicit:STATe□“PROG”,{RUN|PAUSE|STOP|CONTInue}

See “:PROGrama[:SElected]:STATe□{RUN|PAUSE|STOP|CONTInue}”.

:PROGrama:EXPLicit:STRing□“PROG”,<varname>[,<string>]

See “:PROGrama[:SElected]:STRing□<string (varname)>,<string (value 1)>[,<string (value
2)> [, ... [,<string (value n)>]”.

:PROGrama:EXPLicit:WAIT “PROG”

See “:PROGrama[:SElected]:WAIT”.

Status Notations and Error Messages

Status Notations

Displays the current status of various functions for the active channel. The following notations are used:

*	Sweep parameters changed: measured data in doubt until a complete fresh sweep has been taken.
P	RF output is ON (zero span in spectrum analyzer mode only).
Cor	Error correction is ON (network analyzer mode and impedance analyzer mode). Level correction is ON (spectrum analyzer mode only).
C2	Two-port error correction is ON (network analyzer mode only).
Cmp	Fixture compensation is ON (impedance analyzer mode only).
C?	Sweep parameters have changed ¹ and interpolated error correction is ON (network analyzer mode and impedance analyzer mode).
C2?	Sweep parameters have changed ¹ and interpolated two-port correction is ON (network analyzer mode only).
Cm?	Sweep parameters have changed ¹ and interpolated fixture compensation is ON (impedance analyzer mode only).
C!	Sweep parameters have changed ² and extrapolated error correction is ON (network analyzer mode and impedance analyzer mode).
C2!	Sweep parameters have changed ² and extrapolated two-port correction is ON (network analyzer mode only).
Cm!	Sweep parameters have changed ² and extrapolated fixture compensation is ON (impedance analyzer mode only).
Cm*	Fixture compensation is ON when error correction is C? or C! (impedance analyzer mode only).
De1	Electrical delay, port extension, or phase offset has been added or subtracted (network analyzer mode and impedance analyzer mode).
Neg	Negative peak detection is ON (spectrum analyzer mode only).
Smp	Sample detection is ON (spectrum analyzer mode only).
Avg	Sweep-by-sweep averaging is ON. The averaging count is shown below.
Max	Maximum hold is ON.
Min	Minimum hold is ON.
G*	Data math Gain is ON.
-0	Data math Offset is ON.
G&0	Data math Gain is ON and data math Offset is ON.
D-M	Data math (Data Trace - Memory Trace) is ON.
D+M	Data math (Data Trace + Memory Trace) is ON.
D/M	Data math (Data Trace / Memory Trace) is ON.
Hld	Hold sweep.
↑	Sweep indicator. (When sweep time is longer than 2 seconds, it appears on the trace).
ext	Waiting for external trigger (BNC in rear panel).
man	Waiting for manual trigger.
bus	Waiting for GPIB trigger.
Svc	A service mode is turned on. If this notation is shown, the measurement data will be out of specifications. (See <i>Service Manual</i> .)

1 Frequency span reduced, etc.

2 Frequency span expanded, etc.

Error Messages in Numerical Order

Note

No status notation is displayed when Gate trigger is used.



This section lists the error messages that are displayed on the analyzer display or transmitted by the instrument over GPIB. Each error message is accompanied by an explanation, and suggestions are provided to help in solving the problem. Where applicable, references are provided to the related chapter of the appropriate manual.

When displayed, error messages are preceded with the word “CAUTION:.” That part of the error message has been omitted here for the sake of brevity. Some messages without the “CAUTION:” are for information only, and do not indicate an error condition. The messages are listed first in alphabetical order because the displayed messages do not contain the message number. The messages are then listed in numerical order to make them easier to find if they are read over the GPIB.

Error Messages in Numerical Order

+0 No error

The error queue is empty. Every error in the queue has been read (OUTPERRO? query) or the queue was cleared by power-on or the *CLS command.

1 CAN'T SET RBW AUTO IN ZERO SPAN

The RBW AUTO mode cannot be selected in the zero span. The RBW must be specified manually in the zero span. (spectrum analyzer mode only).

10 ADDITIONAL STANDARDS NEEDED

Error correction for the selected calibration class cannot be computed until all the necessary standards have been measured.

11 CALIBRATION REQUIRED

No valid calibration coefficients were found when you attempted to turn calibration ON.

12 NO CALIBRATION CURRENTLY IN PROGRESS

The **RESUME CAL SEQUENCE** softkey is not valid unless a calibration is in progress. Start a new calibration.

13 CALIBRATION ABORTED

The calibration in progress was terminated due to a change of the active channel or stimulus parameters.

14 NOT VALID FOR PRESENT TEST SET

The calibration requested is inconsistent with the test set present. This message occurs in the following situations:

- A full 2-port calibration is requested with a test set other than an S-parameter test set.
- A one-path 2-port calibration is requested with an S-parameter test set (this procedure is typically used with a transmission/reflection test set).

15 EXCEEDED 7 STANDARDS PER CLASS

A maximum of seven standards can be defined for any class. See “Modifying Calibration Kits” in the *Function Reference*.

16 CURRENT PARAMETER NOT IN CAL SET

GPIB only. Correction is not valid for the selected measurement parameter.

17 BACKUP DATA LOST

Data checksum error on the battery backup memory has occurred. The battery is recharged for approximately 10 minutes after power was turned ON.

19 UNEXPECTED DATA DETECTED: CAL ABORTED

The signal measured for the level cal is not adequate for the calibration signal. (spectrum analyzer mode only.)

26 PRINTER: not on, not connect, wrong address

The printer does not respond to control. Check the supply to the printer, online status, sheets, and so on.

34 NO VALID MEMORY TRACE

If a memory trace is to be displayed or otherwise used, a data trace must first be stored to memory.

37 DISPLAY BUFFER IS FULL

The display buffer is filled with the overlay traces or traces drawn by IBASIC DRAW/MOVE commands, etc.

44 OVERLOAD ON INPUT B

The power level at one of the four receiver inputs exceeds a certain level greater than the maximum input level.

45 OVERLOAD ON INPUT A

The power level at one of the four receiver inputs exceeds a certain level greater than the maximum input level.

Error Messages in Numerical Order

46 OVERLOAD ON INPUT R

The power level at one of the four receiver inputs exceeds a certain level greater than the maximum input level.

48 PHASE LOCK LOOP UNLOCKED

EXT REF Input of 10 MHz is not proper, or the instrument is needed to adjust or repair. Check the external reference signal first. Contact your nearest Agilent Technologies office for adjustment or repair.

50 CONT POWER CHANGE >30dB MAY DAMAGE MECH SW

RF output power switch is switching sweep by sweep, because RF power level or the input attenuator setting is different between two channels and the dual channel is turn on. To avoid premature wearing out of the output power switch and input attenuator switch, change trigger type to HOLD, SINGLE, or NUMBER of GROUPS to hold sweep after measurement required. Or turn off the dual channel, or set the power level and the input attenuator of both channels to the same setting.

51 MEASUREMENT INVALID AT $f \leq (5 * \text{IFBW})$

This message will displayed when whole frequency measured is less than or equal to 1 MHz and IFBW is set to 10 kHz or 40 kHz because the network measurement performance is not warranted at frequency ≤ 1 MHz with 10 kHz or 40 kHz IFBW.

52 CONT SWITCHING MAY DAMAGE RCVR ATTEN

Input attenuator switch at input R, A, or B is switching sweep by sweep, because the attenuator setting of one of the inputs is different between two channels and the dual channel is turn on. To avoid premature wearing out of the input attenuator switch, change trigger type to HOLD, SINGLE, or NUMBER of GROUPS to hold sweep after measurement required. Or turn off the dual channel, or set the input attenuator of both channels to the same setting.

54 TOO MUCH DATA

Either there is too much binary data to send to the analyzer when the data transfer format is FORM 2, FORM 3 or FORM 5, or the amount of data is greater than the number of points.

55 NOT ENOUGH DATA

The amount of data sent to the analyzer is less than that expected (*GPIB only*).

56 OPTION NOT INSTALLED

This error occurs when an GPIB command which is optional command is sent and the analyzer is not installed the option (*GPIB only*). Please confirm options installed to the analyzer using *OPT? command.

64 TOO MANY SEGMENTS

The maximum number of segments for the limit line table is 18.

74 CURRENT EDITING SEGMENT SCRATCHED

The current editing segment for the list table and the limit line is scratched when the following cases occur (*GPIB only*) :

- When EDITLIST (edit list table) command is received while editing a segment for the list table.
- When EDITLIML (edit limit line) command is received while editing a segment for the limit line.

Send LIMSDON (limit segment done) or SDON (segment done) to terminate editing segment.

75 COMMAND IGNORED - SEGMENT NOT DONE YET

The GPIB command the analyzer received is ignored, because the segment is editing (*GPIB only*). Send LIMSDON (limit segment done) or SDON (segment done) to terminate editing segment.

76 SEGMENT START/STOP OVERLAPPED

Segments are not allowed to be overlapped. Reenter appropriate value for start or stop value of segments to avoid that segment is not overlapped.

77 TOO MANY SEGMENTS OR POINTS

Frequency list mode is limited to 31 segments or 801 points.

78 TOO SMALL POINTS OR TOO LARGE STOP

STOP+SPAN/(NOP-1) is out of sweep range. Increase NOP or change STOP value to lower frequency to avoid this error.

82 CAN'T CHANGE- ANOTHER CONTROLLER ON BUS

The analyzer cannot assume the mode of system controller until the active controller is removed from the bus or relinquishes the bus.

83 FORMAT NOT VALID FOR MEASUREMENT

The conversion function except the 1/S and the multiple phase modes is not valid for the Smith, admittance, and SWR formats.

84 ANALYZER TYPE MISMATCH

The analyzer receives a command that is not available for the current analyzer type. Please confirm GPIB command or change analyzer type before sending the command.

Error Messages in Numerical Order

93 NO DATA TRACE

The **MARKER ON [DATA]** is selected when the data trace is not displayed.

94 NO MEMORY TRACE

The **MARKER ON [MEMORY]** is selected when the memory trace is not displayed.

95 NO MARKER DELTA - SPAN NOT SET

The **MKRΔ→SPAN** softkey requires that delta marker mode be turned ON.

96 NO MARKER DELTA - RANGE NOT SET

The **MKRΔ→SEARCH RNG** softkey requires that delta marker is turned ON.

97 CAN'T CHANGE WHILE DATA MATH ON

The setting cannot be changed when the data math function is used.

98 NO ACTIVE MARKER

The marker→ command cannot be execute when no marker is displayed on the screen. Turn on the marker before executing the marker→ commands.

99 CAN'T CHANGE WHILE DUAL CHAN OFF

The Cross channel cannot be turned on when dual channel is off. Turn on the dual channel before the cross channel is turned on.

100 NO FIXED DELTA MARKER

The **FIXED ΔMKR VALUE** and **FIXED ΔMKR AUX VALUE** softkey requires that fixed delta marker is turned ON.

110 SAVE ERROR

A serious error, for example physically damaged disk surface, is detected on saving a file.

111 RECALL ERROR: INSTR STATE PRESET

A serious error, for example corrupted data, is detected on recalling a file, and this forced the analyzer to be PRESET.

112 INVALID FILE NAME

GPIB only. The file name for the RECALL, PURGE, or RE-SAVE function must have a “_D” or “_S” extension for LIF format.

113 NO STATE/DATA FILES ON DISK

There are no files on the flexible disk with extensions, “_D” or “_S” for LIF format, or “STA” or “.DTA” for DOS format.

114 CAN'T SAVE GRAPHICS WHEN COPY IN PROGRESS

If you attempt to save graphics when a print is in progress, this error message is displayed.

115 LIF-DOS COPY NOT ALLOWED

If you try to copy a file between the memory disk and the flexible disk when the format of the memory disk is different from the format of the flexible disk, this message is displayed.

116 NO STATE/DATA FILES ON MEMORY

There are no files on the memory disk with extensions, “_D” or “_S” for LIF format, or “.STA” or “.DTA” for DOS format.

117 DUPLICATE FILE EXTENSION

The extension name entered is already used for other file types. Use other extension name.

119 NO DATA TRACE DISPLAYED

The **SCALE FOR [DATA]** is selected when the data trace is not displayed.

120 NO MEMORY TRACE DISPLAYED

The **SCALE FOR [MEMORY]** is selected when the memory trace is not displayed.

124 LIST TABLE EMPTY OR INSUFFICIENT TABLE

The frequency list is empty. To implement the list frequency mode, add segments to the list table.

126 CAN'T CHANGE NUMBER OF POINTS

The number of points of the spectrum analyzer mode cannot be to change manually, except in zero span.

127 CAN'T SET SWEEP TIME AUTO IN ZERO SPAN

The automatic sweep time cannot be in zero span of the spectrum analyzer mode. (The network analyzer mode allows that the automatic sweep time is turned on.)

128 SPAN = 0 ONLY

The setup must be zero span and spectrum analyzer mode when turning on the RF OUTPUT.

131 FREQUENCY SWEEP ONLY

The sweep type must be frequency sweep when the center step size is set.

Error Messages in Numerical Order

133 CAN'T CHANGE ON LIST SWEEP

When list sweep is selected, the following parameters are not allowed to be changed:

- CENTER, SPAN, START, STOP
- NOP
- IFBW or RBW
- POWER
- DC SOURCE

Modify the list table to change these parameters in the list sweep.

134 CAN'T COUPLE IN CURRENT INPUTS

When one channel measures a ratio measurement, and the other one measures an absolute measurement (for example: A/R and B), **COUPLED CH** can not be turned on.

135 COUPLED CHAN - BETWEEN NA&NA OR ZA&ZA

The analyzer types of both channels must be the network analyzer mode or impedance analyzer mode when the coupled channel is turned on. It is not possible to turn the coupled channel on in spectrum analyzer mode.

136 DC SOURCE OVERLOAD

The DC SOURCE output is overloaded.

137 DC CURRENT LIMIT OCCURED

The output current at DC SOURCE port is reached to an upper limit and the output voltage is reduced so that the current does not exceed the upper limit. This message appears when the DC SOURCE port is used in voltage control mode.

138 DC VOLTAGE LIMIT OCCURED

The output voltage at DC SOURCE port is reached to an upper limit and the output current is reduced so that the voltage does not exceed the upper limit. This message appears when the DC SOURCE port is used in current control mode.

141 INSUFFICIENT MEMORY

If a lot of tasks is executed at same time, memory might be insufficient for a while. (For example, running HP Instrument BASIC program, printing a screen, and sending or receiving data array by GPIB are required at same time.) Please wait until finishing some tasks then execute the next task.

146 ON POINT NOT ALLOWD FOR THE CURRENT TRIG

The trigger event mode cannot be changed to the ON POINT mode because the current trigger source setting does not allow the ON POINT mode. The ON POINT mode is available for only MANUAL, EXTERNAL, and BUS trigger sources of the network analyzer mode.

154 INVALID DATE

The date entered to set the real time clock is invalid. Reenter correct date.

173 ACTIVE/SYSTEM CONTROLLER REQUIRED

When the 4395A and its peripherals are controlled using the Instrument BASIC, you must set the GPIB system's control mode to the system controller mode.

184 NOT ALLOWED IN SVC MODE

The operation is not allowed in service mode.

193 POWER ON TEST FAILED

Power on test failed. Contact your nearest Agilent Technologies office.

267 COMPENSTATION REQUIRED

Compensation is required. Perform compensation to obtain compensation data.

268 NO COMPENSATION CURRENTLY IN PROGRESS

No compensation is currently in progress.

269 COMPENSATION ABORTED

Compensation data acquisition process is aborted.

270 COMPENSATION STD LIST UNDEFINED

Compensation standard list is undefined.

-100 Command error

This is a generic syntax error that the analyzer cannot detect more specific errors. This code indicates only that a command error, as defined in IEEE 488.2, 11.5.1.1.4, has occurred.

-101 Invalid character

A syntax element contains a character that is invalid for that type. For example, a header containing an ampersand (SENSE&).

-102 Syntax error

An unrecognized command or data type was encountered. For example, a string was received when the analyzer was not expecting to receive a string.

-103 Invalid separator

The parser was expecting a separator and encountered an illegal character. For example, the semicolon was omitted after a program message unit, *RST:TRIG.

Error Messages in Numerical Order

–104 Data type error

The parser recognized an unallowed data element. For example, numeric or string data was expected but block data was encountered.

–105 GET not allowed

A Group Execute Trigger (GET) was received within a program message (see IEEE 488.2, 7.7).

–108 Parameter not allowed

More parameters were received than expected for the header. For example, the *SRE command only accepts one parameter, so receiving *SRE 4,16 is not allowed.

–109 Missing parameter

Fewer parameters were received than required for the header. For example, the *SRE command requires one parameter, so receiving only *SRE is not allowed.

–110 Command header error

An error was detected in the header. This error message is used when the analyzer cannot detect the more specific errors described for errors –111 through –119.

–111 Header separator error

A character that is not a legal header separator was encountered while parsing the header. For example, no white space followed the header, thus *SRE4 is an error.

–112 Program mnemonic too long

The header contains more than twelve characters (see IEEE 488.2, 7.6.1.4.1).

–113 Undefined header

The header is syntactically correct, but it is undefined for the analyzer. For example, *XYZ is not defined for the analyzer.

–114 Header Suffix out of range

The value of a numeric suffix attached to a program mnemonic makes the header invalid.

–120 Numeric data error

This error, as well as errors –121 through –129, are generated when parsing a data element that appears to be numeric, including the nondecimal numeric types. This particular error message is used if the analyzer cannot detect a more specific error.

–121 Invalid character in number

An invalid character for the data type being parsed was encountered. For example, an alpha character in a decimal numeric or a “9” in octal data.

–123 **Exponent too large**

The magnitude of the exponent was larger than 32000 (see IEEE 488.2, 7.7.2.4.1).

–124 **Too many digits**

The mantissa of a decimal numeric data element contains more than 255 digits excluding leading zeros (see IEEE 488.2, 7.7.2.4.1).

–128 **Numeric data not allowed**

A legal numeric data element was received, but the analyzer does not accept it in this position for a header.

–130 **Suffix error**

This error, as well as errors –131 through –139, are generated when parsing a suffix. This particular error message is used if the analyzer cannot detect a more specific error.

–131 **Invalid suffix**

The suffix does not follow the syntax described in IEEE 488.2, 7.7.3.2, or the suffix is inappropriate for the analyzer.

–134 **Suffix too long**

The suffix contained more than 12 characters (see IEEE 488.2, 7.7.3.4).

–138 **Suffix not allowed**

A suffix was encountered after a numeric element that does not allow suffixes.

–140 **Character data error**

This error, as well as errors –141 through –148, are generated when analyzing the syntax of a character data element. This particular error message is used if the analyzer cannot detect a more specific error.

–141 **Invalid character data**

Either the character data element contains an invalid character or the particular element received is not valid for the header.

–144 **Character data too long**

The character data element contains more than twelve characters (see IEEE 488.2, 7.7.1.4).

–148 **Character data not allowed**

A legal character data element was encountered where prohibited by the analyzer.

Error Messages in Numerical Order

–150 String data error

This error, as well as errors –151 and –158, are generated when analyzing the syntax of a string data element. This particular error message is used if the analyzer cannot detect a more specific error.

–151 Invalid string data

A string data element was expected, but was invalid for some reason (see IEEE 488.2, 7.7.5.2). For example, an END message was received before the terminal quote character.

–158 String data not allowed

A string data element was encountered but was not allowed by the analyzer at this point in parsing.

–160 Block data error

This error, as well as errors –161 and –168, are generated when analyzing the syntax of a block data element. This particular error message is used if the analyzer cannot detect a more specific error.

–161 Invalid block data

A block data element was expected, but was invalid for some reason (see IEEE 488.2, 7.7.6.2). For example, an END message was received before the length was satisfied.

–168 Block data not allowed

A legal block data element was encountered but was not allowed by the analyzer at this point in parsing.

–200 Execution error

This is the generic syntax error that the analyzer cannot detect more specific errors. This code indicates only that an execution error as defined in IEEE 488.2, 11.5.1.1.5 has occurred.

–210 Trigger error

A trigger related error occurred. This error message is used when the analyzer cannot detect the more specific errors described for errors –211 through –219.

–211 Trigger ignored

A GET, *TRG, or triggering signal was received and recognized by the analyzer but was ignored because of analyzer timing considerations. For example, the analyzer was not ready to respond.

–213 Init ignored

A request for a measurement initiation was ignored as another measurement was already in progress.

–220 **Parameter error**

Indicates that a program data element related error occurred. This error message is used when the analyzer cannot detect the more specific errors described for errors –221 through –229.

–221 **Settings conflict**

A legal program data element was parsed but could not be executed due to the current device state (see IEEE 488.2, 6.4.5.3 and 11.5.1.1.5).

–222 **Data out of range**

A legal program data element was parsed but could not be executed because the interpreted value was outside the legal range as defined by the analyzer (see IEEE 488.2, 11.5.1.1.5).

–223 **Too much data**

A legal program data element of block, expression, or string type was received that contained more data than the analyzer could handle due to memory or related device-specific requirements.

–224 **Illegal parameter value**

Used where exact value, from a list of possibilities, was expected.

–225 **Data out of memory**

The analyzer has insufficient memory to perform the requested operation.

–230 **Data corrupt or stale**

Possibly invalid data. New reading started but not completed since last access.

–231 **Data questionable**

Indicates that measurement accuracy is suspect.

–240 **Hardware error**

Indicates that a legal program command or query could not be executed because of a hardware problem in the analyzer. Definition of what constitutes a hardware problem is completely device-specific. This error message is used when the analyzer cannot detect the more specific errors described for errors –241 through –249.

–241 **Hardware missing**

A legal program command or query could not be executed because of missing analyzer hardware. For example, an option was not installed.

–250 **Mass storage error**

Indicates that a mass storage error occurred. This error message is used when the analyzer cannot detect the more specific errors described for errors –257.

Error Messages in Numerical Order

–256 File name not found

A legal program command could not be executed because the file name on the device media was not found: for example, an attempt was made to read or copy a nonexistent file.

–257 File name error

Indicates that a legal program command or query could not be executed because the file name on the device media was in error. For example, an attempt was made to copy to a duplicate file name. The definition of what constitutes a file name error is device-specific.

–280 Program error

Indicates that a downloaded program-related execution error occurred. This error message is used when the analyzer cannot detect the more specific errors described for errors –281 through –289.

–281 Cannot create program

Indicates that an attempt to create a program was unsuccessful. A reason for the failure might include not enough memory.

–282 Illegal program name

The name used to reference a program was invalid. For example, redefining an existing program, deleting a nonexistent program, or in general, referencing a nonexistent program.

–283 Illegal variable name

An attempt was made to reference a nonexistent variable in a program.

–284 Program currently running

Certain operations dealing with programs may be illegal while the program is running. For example, deleting a running program might not be possible.

–285 Program syntax error

Indicates that a syntax error appears in a downloaded program. The syntax used when parsing the downloaded program is device-specific.

–286 Program runtime error

A program runtime error of the HP Instrument BASIC has occurred. To get a more specific error information, use the **ERRM\$** or **ERRN** command of the HP Instrument BASIC.

–310 System error

Some error, termed “system error” by the analyzer, has occurred.

–311 Memory error

An error was detected in the analyzer’s memory.

-330 Self-test failed

A self-test failed. Contact your nearest Agilent Technologies office or see the *Service Manual* for troubleshooting.

-350 Queue overflow

A specific code entered into the queue in lieu of the code that caused the error. This code indicates that there is no room in the queue and an error occurred but was not recorded.

-400 Query errors

This is the generic query error that the analyzer cannot detect more specific errors. This code indicates only that a query error as defined in IEEE 488.2, 11.5.1.1.7 and 6.3 has occurred.

-410 Query INTERRUPTED

A condition causing an interrupted query error occurred (see IEEE 488.2, 6.3.2.3). For example, a query followed by DAB or GET before a response was completely sent.

-420 Query UNTERMINATED

A condition causing an unterminated query error occurred (see IEEE 488.2, 6.3.2.2). For example, the analyzer was addressed to talk and an incomplete program message was received by the controller.

143 FLOATING POINT ERROR OCCURED





Indicate that a floating point error occurred in the analyzer. Data processing may not be correct. This error message is used when an internal application was executed for illegal data sent from an external device, or when an internal software bug was detected. Contact your nearest Agilent Technologies office.

Index

Special characters

* , Messages-1
-0, Messages-1
↑ , Messages-1

A



ABORT, 1-3
active controller, 1-3
address, 1-2, 2-1
addressable only , 8-10
ALL BASIC , 9-2
ALL INSTRUMENT , 9-2
amplitude value , 8-4
ANAOCH, 8-54
arrow key
 , 9-15
 , 9-15
 , 9-15
 , 9-15
 , 9-15
ASCII data transferring , 3-9
ASSIGN, 2-2, 2-5
AUTOREC, 10-2
AUTOST, 10-2
autostart, 10-2
auxiliary amplitude value, 8-4
averaging, 6-3
averaging ON Avg , Messages-1
Avg , Messages-1

B

back space, 9-4
, 9-15
BASIC STATUS , 9-2
binary data transfer, 3-11
Bus , Messages-1

C

C! , Messages-1
C?, Messages-1
C2 , Messages-1
C2! , Messages-1
C2? , Messages-1
calibration array, 3-17

calibration coefficient, 3-16
CALIBRATION COEFFICIENT ARRAY , 3-4
CALIBRATION COEFFICIENT ARRAYS,
 3-1, 3-2, 3-10
CALIBRATION COEFFICIENT ARRAYS ,
 3-18
calibration type, 3-17
, 9-15
CAT, 9-8
CAT, 9-19
character
 deleting, 9-4
 inserting, 9-4
character entry key, 9-15
CIN, C-5
CLEAR I/O, 9-19
COMMAND ENTRY , 9-3
COMMAND ENTRY, 9-19
condition register , 5-3
CONT, 6-2
Continue, 9-19
controller , 1-3
Cor , Messages-1
COUT, C-12
, 9-15
cursor
 moving, 9-4

D

data arrays, 3-1
DATA ARRAYS, 3-1, 3-2, 3-6, 3-10
data format, 3-1, 3-13
data level, 3-16
data math gain ON G* , Messages-1
data math offset ON -0 , Messages-1
data math ON D-M, D+M, D/M, Hld , Messages-1
DATA TRACE ARRAYS, 3-1, 3-2, 3-8, 3-10
data transfer, 3-13
DATE, 9-21
DATE\$, 9-21
DATMEM, 3-2
Del , Messages-1
, 9-16
device selector , 1-3
DIN, D-7

DISPLAY ALLOCATION , 9-2

D+M , Messages-1

D/M , Messages-1

D-M , Messages-1

DOS format , 10-3

DOS format , 9-7

DOUT , D-12

DUAC , 8-54

dual channel function , 8-54

E

Edit , 9-19

EDITLIML , 8-6

EDIT mode , 9-3

ENABLE INTR , 5-15

enable register , 5-3

End , 9-16

Enter , 9-15, 9-16

ENTER , 2-2

"ERROR -257" , 9-7

error corrected data , 3-16

error correction ON Cor , Messages-1

*ESE , 5-11

ESNB , 5-14

*ESR? , 5-13

event register , 5-2

Event Status Enable Register , 5-11

Event Status Enable Register B , 5-14

Event Status Register B , 5-8, 5-14

EXECUTE , 9-21

Ext , Messages-1

F

fast sweep indicator ↑ , Messages-1

file header , 3-14

file name

listing , 9-8

"File name error" , 9-7

file transfer , 8-46

floppy disk drive , 10-3

FORM2 , 3-12

FORM3 , 3-12

FORM4 , 3-10

FORM5 , 3-12

FORMAT OFF , 3-12

format option , 10-3

formatted data , 3-16

G

G* , Messages-1

general status register model , 5-2

GET , 6-4, 9-19

GET , 9-9

G&O , Messages-1

GPIB address , 8-55, 9-2

GPIB address , 1-3

graphics , 9-13

group execution trigger , 6-4

H

HALF INSTR HALF BASIC , 9-2

hard copy , 9-6, 9-14

Hld , Messages-1

HOLD , 6-2

hold ON Max,Min , Messages-1

Home , 9-16

HP Instrument BASIC , 1-3

HP Instrument BASICC , 9-1

I

IBASIC , 9-1

INITIALIZE , 9-19, 10-3

INP8IO? , 7-3

INP8IO? , 7-4

INPDATA , 3-6

INPDTRC , 3-8

INPT? , I-1

INPUCALC{1-12} , 3-2

INPUCALC{1-12}? , 3-4

INPUDATA , 3-2

INPUDTRC , 3-2

INPURAW{1-4} , 3-2

insert , 9-16

Instrument Event Status Register , 5-8, 5-14

":INTERNAL" , 9-7, 10-3

interpolated error correction ON C? , C2? ,
 Messages-1

interruption , 5-1

I/O interfaces , 9-12

i/o port , 7-1

i/o port , 7-4

I/O port , 9-22, 9-23

K

keyboard , 9-15

L

label function , 9-9

LIF format , 10-3

LIF format , 9-7

LIMCLEL , 8-6

LIMEDONE , 8-6

LIMILINE , 8-6

LIMITEST , 8-6

LIML , 8-6

LIMPRM , 8-6

LIMSADD , 8-6

LIMSDON , 8-6

LIMU, 8-6

line

- clearing, 9-5
- deleting, 9-5
- inserting, 9-5
- jumping, 9-5
- recalling, 9-5
- renumber, 9-6
- scrolling, 9-4

list, 9-6

- on the screen, 9-6
- to printer, 9-6

LIST, 9-19

M

Man , Messages-1

manual changes, 12-1

marker , 8-2

Max , Messages-1

maximum hold ON Max , Messages-1

":MEMORY", 9-7, 10-3

MEMORY ARRAYS, 3-1, 3-2, 3-10

memory disk, 10-4

MEMORY TRACE ARRAYS, 3-1, 3-2, 3-10

Min , Messages-1

minimum hold ON Min , Messages-1

MSI [], 9-19

MSS , 5-3

N

Neg , Messages-1

negative peak detection ON Neg , Messages-1

NEGL, N-1

(Num Lock), 9-16

O

OFF CYCLE, 9-24

ON CYCLE, 9-24

ON INTR, 5-15

On Key Label function, 9-9

ON KEY LABELS, 9-19, U-1

Operation Status Negative Transition Filter,
5-9

Operation Status Positive Transition Filter, 5-9

Operation Status Register, 5-8

OSNT, 5-9

OSPT, 5-9

OUT1ENVH, O-4

OUT1ENVL, O-4

OUT1H, O-5

OUT1L, O-5

OUT2ENVH, O-5

OUT2ENVL, O-5

OUT2H, O-5

OUT2L, O-5

OUT8IO, 7-2

OUT8IO , 7-4

OUTAIO□<numeric>, O-6

OUTBIO□<numeric>, O-6

OUTCIO□<numeric>, O-6

OUTDIO□<numeric>, O-6

OUTEIO□<numeric>, O-7

OUTFIO□<numeric>, O-7

OUTGIO□<numeric>, O-7

OUTHIO□<numeric>, O-7

OUTPCALC{1-12}?, 3-4

OUTPDATA?, 3-6

OUTPDTRC?, 3-8, 3-10, 3-12

OUTPERRO?, 5-12

OUTPFAIP?, 8-6

OUTPINPCIO?, O-9, O-11

OUTPINPDIO?, O-11

OUTPINPEIO?, O-12

OUTPLIMF?, 8-6

OUTPMARK?, 8-3

OUTPSWPRM?, 3-10, 3-12

OUTPUT, 2-1

P

P , Messages-1

P? , Messages-1

(Page Down), 9-15

(Page Up), 9-15

PASS CONTROL, 1-3

pass control , 9-10

P↓ , Messages-1

PEN, 9-24

POSL, P-7

power slope ON Slp , Messages-1

PRINALL, 8-10

printer

- list to, 9-6

PRINTER IS, 9-6

program

- executing, 1-8
- getting, 9-9
- listing, 9-6
- running, 1-8
- saving, 9-7
- saving , 1-8

Program Module

- reading an event register , 5-10

PROGram[:SElected]: NUMBer, 9-12

program speed

- increasing, 8-54

PURGE, 9-7, 9-19

Q

Query, 2-2

R

raw data, 3-16
RAW DATA ARRAYS, 3-1, 3-2, 3-10
reading an event register directly , 5-10
READIO , 9-22
remote mode, 2-2
RENumber, 9-19
RE-SAVE, 9-7, 9-19
RESET, 9-19
rf output OFF P↓ , Messages-1
rf output ON P , Messages-1
RQS , 5-3
Run, 9-19
RUN/CONTINUE input , 9-12
run light indication, 9-20
running a program through the softkey interface,
10-1

S

sample peak detection ON Smp , Messages-1
sample program disk , vi
SAVC, 3-2
SAVDTIF□<string>, S-4
SAVE, 9-7, 9-19
SCRATCH, 9-19
screen area
 allocating, 9-2
select code, 2-1, 9-2, 9-12
serial number, 12-2
serial poll , 5-3
service request , 5-3
Service Request Enable Register, 5-11, 5-14
service request (SRQ), 5-1
SET TIME, 9-22
SET TIMEDATE, 9-22
(Shift), 9-15
(Shift) - (Delete), 9-16
(Shift) - (End), 9-16
(Shift) - (Insert), 9-16
SING, 6-3
Slp , Messages-1
Smp , Messages-1

softkeys, 9-17
SPOLL, 5-13
SPOLL , 5-3
*SRE, 5-11, 5-14
SRQ, 5-1
SRQ , 5-3
standard class, 3-17
Standard Event Status Register, 5-7, 5-11
Status Byte, 5-6
Status Byte Register, 5-11, 5-14
status byte register , 5-3
status register
 using , 5-10
status reporting system , 5-1
*STB , 5-3
Step, 9-19
Stop, 9-19
storage device, 10-3
Svc, Messages-1
system controller, 1-3
system controller , 8-10

T

(Tab), 9-15
TIME, 9-23
TIME\$, 9-23
To observe printing , 8-10
transferring a program , 9-11
transition filter , 5-3
*TRG, 6-4
TRGS BUS, 6-4
TRGS INT, 6-2
TRIGGER, 6-4
trigger signal , 9-12
trigger source, 6-1, 6-2
trigger system , 6-1
two-port error correction ON C2 , Messages-1

V

value 1 , 8-4
value 2 , 8-4

W

WIDTH, 9-8
WRITEIO , 9-23
Write strobe, 7-6